

NOTE: If the fuse panel on your 510055 Mustang kit dash harness looks like the photo at the left, you have the first design harness and your instructions follow this title page.



**American
Autowire**

www.americanautowire.com 856-933-0801

67-8 Mustang First Design Instructions

92972205 rev. 0.0 7/20/2018



WARNING: Validate the kit contents with the component list included on page 2 of this sheet before proceeding. This harness is intended to be used in a modified vehicle. Please read this sheet thoroughly and be sure that you understand everything explained on it prior to opening any of the enclosed packages, or before attempting to install any of the components. Once this kit has been opened or a component installed, the kit is not returnable.

1. This kit should typically be used in a **MODIFIED 1967-1968 Mustang** application only.
2. Due to space constraints and mounting location of the fuse panel itself, this harness **CANNOT** be used in a vehicle with Factory A/C.
3. This kit only supports the use of a higher current self-exciting 1 wire, or other style internally regulated alternator. An adapter may be necessary for certain applications. The use of a stock, low amperage alternator is seriously discouraged as they cannot handle the higher current requirements of updated ignition systems, electric fans, aftermarket A/C systems, stereo systems, air ride suspensions, and other power hungry accessories and will ultimately create performance issues with the system.
4. This kit **WILL NOT** support the use of a factory ammeter. All AAW kits are engineered to supply the optimum charge to the battery. To achieve this performance, we route our 8ga. charge wire directly from the alternator output terminal to the starter solenoid. Due to the path of the charge being altered from the stock configuration, the gauge can no longer see a charge vs. a discharge, so it will not work properly. When ammeters were originally used, most generator or alternator current outputs were rated at maximum of about 25-60 amps. Modified cars being built today typically utilize a 100 amp or higher output alternator. With these higher current units, ammeters, generally speaking, become a safety hazard. Ammeters are usually wired in parallel to the charging circuit, are typically unfused, and can short very easily causing a fire. A voltmeter is recommended as a good alternative.
5. This kit **WILL NOT** support the use of a factory tachometer in it's original connection application as those tachs wired the primary ignition circuit directly in series through the tach and then out to the positive side of the coil. With this type of connection, any type of MSD or high energy ignition will generally destroy the internal circuitry of the tach and will cause the car to quit running as voltage will no longer flow through the tach and out to the coil or ignition control unit. **HOWEVER**, if your factory tach has been upgraded or retrofitted to a later style movement where the pulse post on the tach gets wired to the negative side of the coil (or to the tach output on an MSD box or similar unit) and the feed post of the tach uses a conventional 12 volt ignition connection, **you will be able to use this harness system.**
6. This kit **IS NOT** set up with a resistance wire for a standard, points type ignition system. It is wired with a full 12 volt primary ignition feed that is hot in both the start and run positions. It will support HEI, MSD, other electronic ignition systems, as well as computerized Fuel Injection systems. If you wish to run a points type system, there are illustrations on the engine connection pages to do so. Extra parts that are not included in this kit will be required to complete that operation.



510055

510055 - Classic Update Series Kit 1967-68 Ford Mustang

This kit contains the following components:

<u>Bag</u>	<u>Part Number</u>	<u>Description</u>	<u>Quantity</u>
	500042	Floor Dimmer Switch	1
	500919	Practice Terminal Crimping Set	1
	510047	Dash and Main Harness Kit	1
M	510052	Rear Body Wiring Kit	1
	510053	Ignition Switch	1
	510054	Headlight Switch	1
	510058	Fuse, Relay, and Flasher Kit	1
N	510131	Wiper Feed Kit	1
	510176	Grommet, Clamp, and Parts Kit	1
	92968935	Installation Instruction Sheet	1
	92969971	Warning Sheet	1

Validate the kit contents with this component list. If there are any discrepancies with incorrect or missing parts, stop your installation and notify the supplier you purchased the kit from before proceeding.



www.americanautowire.com 856-933-0801

510055

92969971 instruction sheet Rev 1.0 7/24/2013

Classic Update Series

1967 - 1968 Ford Mustang

START HERE !

PLEASE READ THIS BEFORE STARTING INSTALLATION !

This wiring kit is designed for ease of installation. Please read the guidelines below, BEFORE STARTING your installation to guarantee a successful job. Use an appropriate crimping tool which folds the wings of the open barrel terminals down into the wire as shown below. ALL TERMINALS THAT YOU INSTALL SHOULD BE PROPERLY SOLDERED. Our factory crimped terminations are installed by GM approved five ton presses, and soldering these terminations is not necessary.



AS THIS HARNESS IS DESIGNED FOR USE IN A MODIFIED CAR REQUIRING A HIGHER RATE OF CHARGE, IT DOES NOT SUPPORT THE USE OF A STOCK (ORIGINAL) ALTERNATOR. IT IS DESIGNED FOR USE WITH AN INTERNALLY REGULATED OR SINGLE WIRE STYLE ALTERNATOR. ADAPTERS (WHICH ARE NOT INCLUDED WITH THIS KIT) ARE AVAILABLE FROM SEVERAL SOURCES WILL BE NECESSARY TO USE ANY ALTERNATOR OTHER THAN A 1 WIRE UNIT.

STEP 1: DISCONNECT YOUR BATTERY:

Disconnect the battery before installing the wiring kit to prevent any accidental shorting caused by loose bare wire ends.

STEP 2: START INSTALLING KIT:

This kit is broken down into individual steps that are identified by a letter printed on the instruction sheets visible through each bag. These letters are the order of operation for installing your kit. Start with bag letter G, then M, etc. The order of installation is shown below. Use this instruction sheet, 92968935, to complete the installation instructions.

G - 510047 Dash Harness Kit
M - 510052 Rear Body Kit
N - 510131 Washer Wiper Harness

STEP 3: RECONNECT YOUR BATTERY:

When you have completed the installation and are ready to reconnect the battery, make sure that the following electrical system grounds are in place:

- A. Battery is grounded to the ENGINE BLOCK.
- B. Battery is grounded to the frame.
- C. Engine block is grounded to the frame.
- D. Body is grounded to the frame.

STEP 4: CHECK ALL ELECTRICAL FUNCTIONS:

Any non-functioning items should be checked for proper installation. Any problems with your wiring and electrical circuit functions should be addressed to American Autowire Systems, Inc. as soon as possible to avoid any warranty problems.

If you have any questions concerning this or any of our products, please feel free to call us at 1-856-933-0801.

AMERICAN AUTOWIRE MAKES IT EASY !!

We carry the following crimping hand tools, to help with your terminal crimping. These hand tools are available, for purchase or rental.

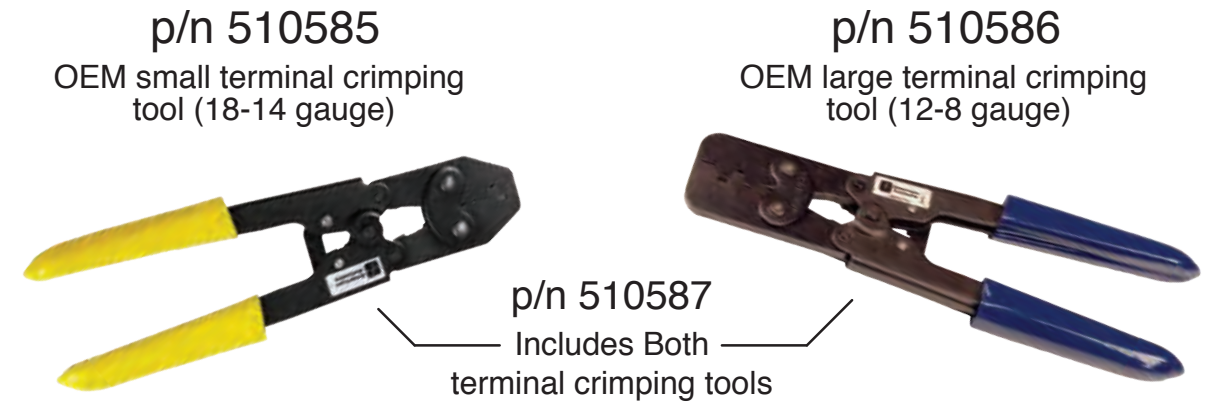

We carry many accessories for your 1967-68 Ford Mustang.



www.americanautowire.com 856-933-0801

PART # **510055**
DESCRIPTION:
**1967-68 Mustang
Classic Update Series Kit**
92968935 Rev 15.0 7/19/2017

See page 12 for fuse placement

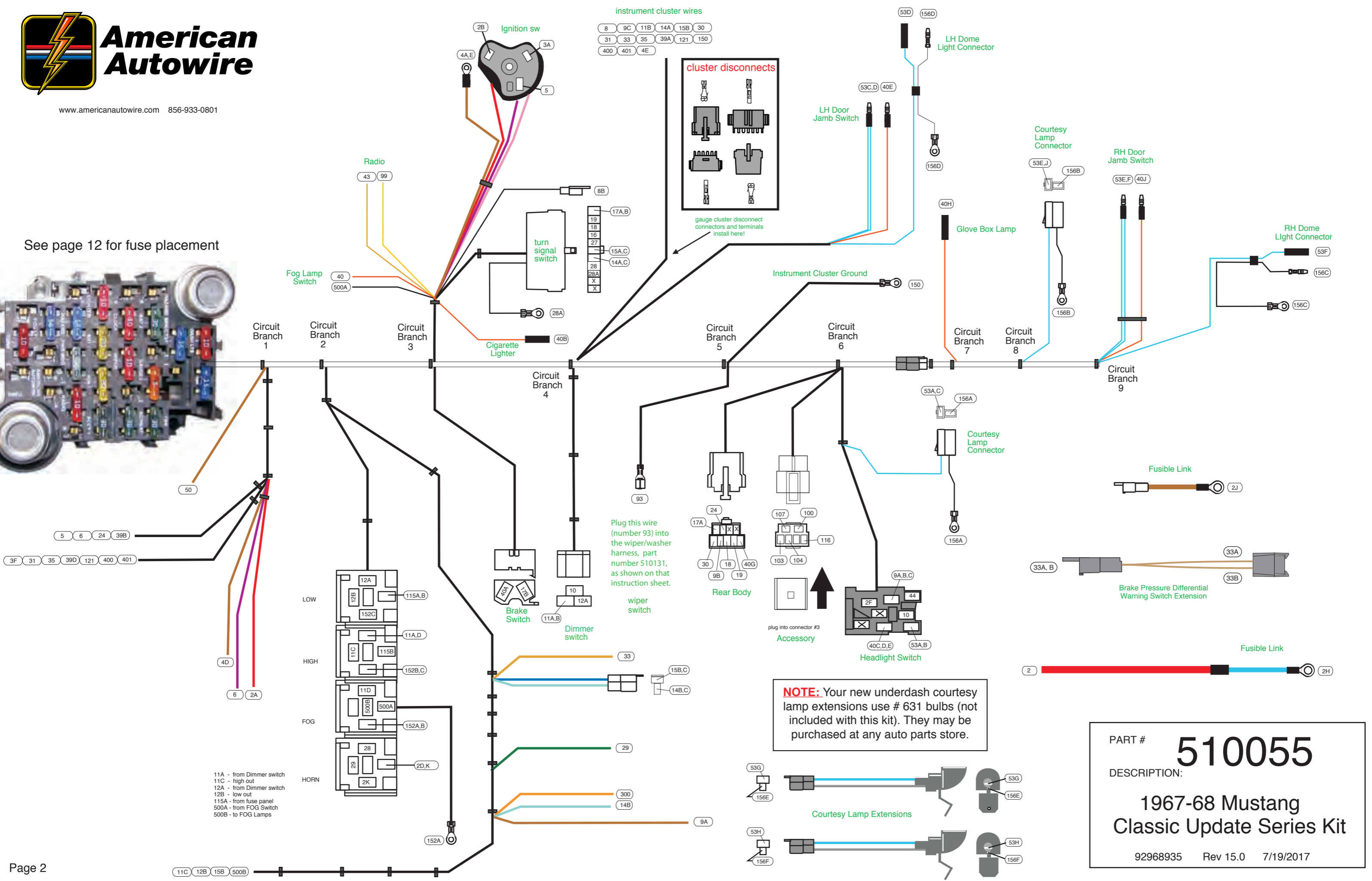
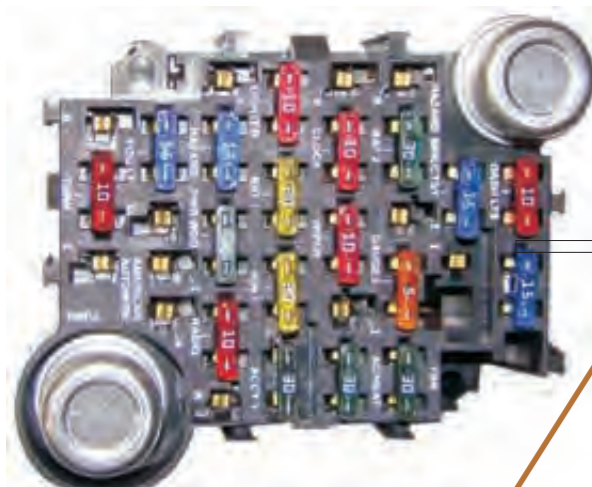

PART # **510055**

DESCRIPTION:
1967-68 Mustang Classic Update Series Kit

92968935 Rev 15.0 7/19/2017

The Main Fuse Panel harness is designed to be mounted under the dash at the firewall in an area close to the steering column. The enclosed representation of the main dash harness shows each circuit branch and identifies each connection by its color and function. Follow this drawing and detail drawings on pages 10 and 11 for the individual circuit connections.

Circuit Branch 1 - Engine and Alt. connections.

See pages 10 and 11, "Figures B, C, and D" for typical connections. Loose piece terminals and connectors are located in kit # 510176.

Wire #	Wire color	Printing
50	Brown	Heater/AC feed
6	Purple	Starter Solenoid-S
2	Red	12 V Battery
2H	Light Blue	Fusible Link
2A	Red	12 V Battery
2J	Brown	Fusible Link
5	Purple	Neutral Safety Switch
24	Lt. Green	Backup Lt Sw-Lights
39B	Pink	12 V Ignition
4D	Brown	Alternator Ign
3F	Pink	Ignition Feed - coil
31	Dark Blue	Oil Pressure Sender
35	Dark Green	Water Temp Sender
39D	Tan	Electric Choke
121	White	Coil - Tach
400	Yellow	VSS Ground
401	Purple	VSS Signal

Procedure
 This is the fused Ignition power lead for the heater or AC control panel. Connect according to the instructions supplied with your aftermarket Heater / AC unit. This can also be used as the 12 volt feed wire to the stock 3 speed heater blower motor if you are utilizing your stock 1967-68 Mustang heating system. See page 11, figure E. Connect the end that comes out with the 5, 24, and 39B wires to 1 terminal on the neutral safety switch. Connect the end that comes out with the heavy red power wire to the "S" terminal on your starter solenoid. (See Figure B) Route this wire to your starter solenoid and connect the ring terminal end with the blue fusible link to the battery terminal on the starter solenoid. Route the other end to the alternator battery stud, install sleeve "C" followed by terminal "D" and attach this completed assembly to the battery terminal of the alternator. (See Figure B) See the connection instructions under wire 2.
 Route this wire to your starter solenoid. Cut to length, install terminal "B", plug into connector "E" as shown on this page. As shown on sheet 9, Figure B, plug connector "E" into the connector on the loose piece fusible link wire 2J, then attach the ring terminal on this assembly to the battery terminal on your starter solenoid. (Parts in 510047 kit) See the connection instructions under wire 2A.
 Connect to the opposite terminal from wire 6 above to a terminal on the neutral safety switch. (See figure C)
 Connect to the backup light terminal on the neutral safety / back up switch. (See figure C)
 Connect to the backup light power terminal on the neutral safety / back up switch. (See figure C)
 This wire is the exciter wire for your alternator / voltage regulator. If you are using a one wire alternator, this wire will not be used and should be capped off as it is "hot" in the ignition "on" position. If you are using an alternator that requires an internal or external voltage regulator, this exciter wire must be connected to the "switched or 12v ignition" terminal on your regulator or alternator according to the manufacturer's specifications for the type of alternator / regulator that is being used. (AAW recommends a GEN 3 Internally Regulated or 1 wire unit)
 This is your 12 volt switched power source for the distributor. This can be connected directly to the "bat" terminal on a typical HEI distributor, to a ballast resistor as in a points type distributor, or be used as the ignition power source for an aftermarket ignition module such as an MSD or "Duraspark" module. See the installation instructions for the type of distributor you are using for specific connection requirements (See page 10 for some examples).
 Connect to the oil pressure sender.
 Connect to the temperature sender.
 On carbureted cars, connect to the electric choke terminal.
 This can be connected directly to the tach terminal on a typical HEI distributor, to the negative side of the coil, or a tach connection in an aftermarket ignition module such as an MSD module. See the installation instructions for the type of ignition system you are using for specific connection requirements.
 Connect to the Vehicle Speed Sensor ground lead (see page 4 for typical connection).
 Connect to the Vehicle Speed Sensor signal lead (see page 4 for typical connection).

Circuit Branch 2- Front Lighting connections.

See page 10, "Figure A" for typical connections. Loose piece terminals and connectors are located in kit 510176.

Wire #	Wire color	Printing
		Relay Pack
152A	Black	Ground
		Brake Pressure Differential Switch
33	Tan	Brake Switch
14B,C	Light Blue	Left Front Turn
15B,C	Dark Blue	Right Front Turn
29	Dark Green	Horn
14B	Light Blue	Left Front Turn
15B	Dark Blue	Right Front Turn
300	Orange	Electric Fan
9A	Brown	Park Lights
11C	Light Green	Headlight-Hi Beam
12B	Tan	Headlight-Low Beam
500B	Black	Fog Lamps

Procedure
 The 4 gang relay panel is directly wired and requires no internal wiring. The relays control the headlight low beams, headlight high beams, fog lamps, and the horn.
 This is the relay pack ground. Connect to a good chassis ground.
 (NOTE:) We have provided you with the connection to the original Ford brake warning switch in the form of a wire extension assembly (wires 33A, B on page 2 of this instruction sheet). You will plug this extension onto wire 33, below.
 Route this wire to the brake warning switch area near the master cylinder, cut to length, install terminal B, plug into connector E as shown on page 10, figure A, then plug this wire into wire extension assembly 33A, B (from page 2 of this instruction sheet) to complete your brake warning circuit.
 These are the connections for the hood mounted directional lights. The mating connector and terminals "B and Q" to complete this branch can be found in the 510047 loose piece dash kit if you are using a stock hood with these lamps. Connect to the horn power terminal. NOTE: If your horn has a separate ground terminal, you must supply the wire for this ground terminal as it is not included in the kit.
 Connect to the left front directional lamp socket. If you are using a single front directional light with an 1157 or dual filament bulb, this wire would be connected to the high intensity filament of the LH front running light.
 Connect to the right front directional lamp socket. If you are using a single front directional light with an 1157 or dual filament bulb, this wire would be connected to the high intensity filament of the RH front running light.
 This is the 12 volt ignition feed to be connected to the trigger wire on your electric fan relay.
 Connect to both the front park / running light sockets. If you are using a single front directional light with an 1157 or dual filament bulb, this wire would be connected to the low intensity filament of each of the front running lights. An in-line splice of this wire or a double up of this wire at the left front parking lamp will be necessary to accommodate the wiring of both of the front park / running lights
 Select the light green Headlight Hi Beam wire (11C) and tan Headlight Low Beam wire (12B). Route and connect these wires to the headlights. An in-line splice of these wires or a double up of these wires at the left front headlight will be necessary to accommodate wiring of both of the headlights. Using the supplied terminals and connectors, connect these wires along with the headlight ground wires to the headlight connectors according to the orientation in the diagram on page 9, Figure A.
 Connect this wire to your fog lamp power wires. An in-line splice or double up of the wire at the left fog lamp before routing to the right fog lamp will be necessary. If the fog lamps have a separate ground wire, you must supply those wires as they are not included in the kit.

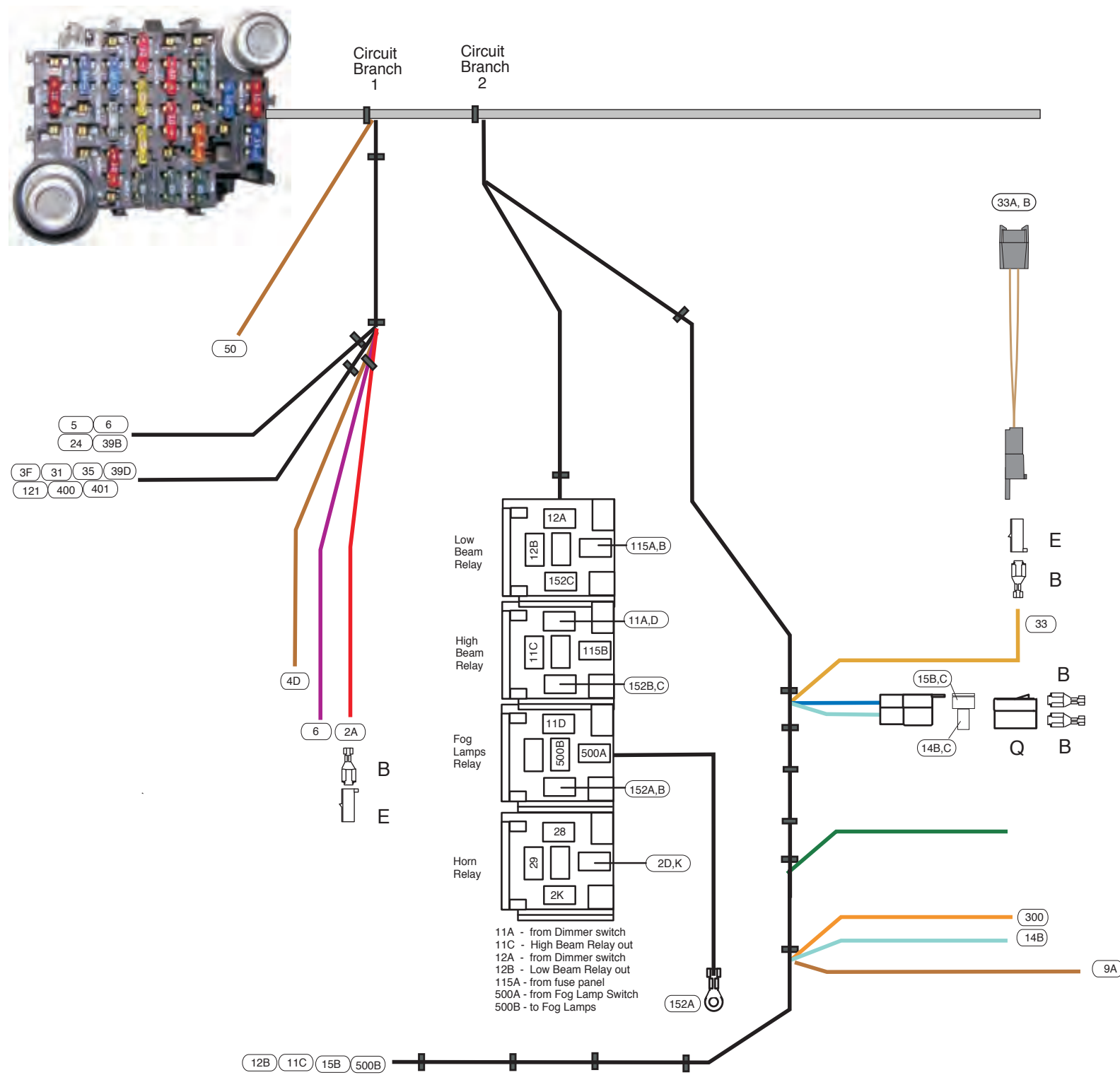

PART # **510055**
 DESCRIPTION:
1967-68 Mustang Classic Update Series Kit
 92968935 Rev 15.0 7/19/2017

Circuit Branch 3 - Under Dash connections

Wire #	Wire color	Printing	Procedure
40	Orange	12V Battery Fused	Connect to "Feed In" on your fog lamp switch (if so equipped). Connect to "Feed out" on your fog lamp switch (if so equipped). Ignition power lead to radio. Battery power lead to radio. Used for original Ford steering column only. See Table "A" - Stock turn signal connection instruction table. Connect to cigarette lighter. Spare dash lamp feed for any accessory dash lamps needed.
500A	Black	Fog Lamps	
43	Tan	Radio	
99	Yellow	Radio Bat	
28A	Black	Horn Relay Ground	
40B	Orange	12V battery Fused	Connect to Brake Switch. Connect to Brake Switch.
8B	Gray	Dash Lights	
Brake Switch connector			
40A	Orange	12V battery Fused	Connect to the provided 1967 style ignition switch.
17B	White	Brake Switch	
Ignition Switch connector			
3A	Pink	Ignition Feed	Install on the ignition switch stud after the main switch connector has been plugged in.
5	Purple	Neutral Safety Switch	
2B	Red	12V Battery	
4A,E	Brown	Ignition Sw Accy	

Turn Signal Switch connector

If you are using a stock Ford turn signal switch, refer to Page 9, Diagram 'A' and Table "A", AAW Turn Signal Switch wires to stock 1967-68 Mustang turn signal switch. This kit is designed to function with a GM style turn signal switch. Our connector mates to a 3 7/8 inch long plug used on 1969-1974 GM, IDIDIT, and many other aftermarket steering columns. Starting from 1975 on up, the GM switch changed the mating connector to use a 4 1/4 inch connector. That connector is from the same family and uses the same terminals. By using the supplied mating connector (L) and terminals (M) located in the loose piece kit bag of this dash harness (510047), it is easy to adapt any steering column to the kit. The function of each wire within the cavities is as follows:

Wire #	Wire color	Printing	Procedure
28	Black	Horn Relay Ground	Horn button ground to the horn relay trigger Feeds the left front turn lamp bulb high filament ,the left hood mounted turn signal bulb, and the left turn dash indicator lamp.
14A,C	Light Blue	Left Front Turn	
15A,C	Dark Blue	Right Front Turn	
27	Brown	Turn Sw - Hazard	4 way hazard power feed wire from the Hazard flasher "L" terminal. Turn signal power feed wire from the Turn Signal flasher "L" terminal.
16	Purple	Turn Switch Feed	
18	Yellow	Left Rear Turn	Feeds the left rear turn and brake lamp bulb high filament.
19	Dark Green	Right Rear Turn	
17A	White	Brake Switch	Power feed wire from the output side of the brake switch.

Circuit Branch 4 - Under Dash connections

Wire #	Wire color	Printing	Procedure
Dimmer Switch connector.			
10	Yellow	Dimmer Switch Feed	Connect to Dimmer Switch. Connect to Dimmer Switch. Connect to Dimmer Switch.
11A,B	Light Green	Headlight Hi Beam	
12A	Tan	Headlight Low Beam	

Left Hand Dome Lamp Feed Wires.

53C,D	Light Blue	12V Ctsy Sw	Connect to Left Hand door jamb switch. Connect to Left Hand door jamb switch. Connect to Left rear dome lamp. Connect the bullet terminal end to the left rear dome lamp. The ring terminal end must be connected to a good chassis ground.
40E	Orange	12V Battery Fused	
53D	Light Blue	12V Ctsy Sw	
156D	White	Ctsy Ground	

Instrument Cluster wires.

See Page 9 - Table 'B' for stock 1967-68 Mustang instrument cluster wiring colors and functions. **Cluster disconnects** have been provided and can be found in the 510047 loose piece bag. We have provided an ample length of wire in order for you to cut an make your own gauge cluster harness. Page 45 identifies a typical instrument cluster wiring scheme. As this kit is designed to function with many different gauge manufacturer's products, it may be necessary to follow the connection requirements specified by the manufacturer of the gauges being used. **As with all AAW kits, the use of a factory ammeter is neither supported, nor is it encouraged.** The function of each AAW wire is as follows:

8	Gray	Dash Lights	Connect to Gauge Lights. Connect to any instrument cluster requiring a signal to dim a digital display. If using regular analog gauges, this wire will not be required.
9C	Brown	Park Lights	
11B	Light Green	Headlight Low Beam	Connect to the high beam indicator light. Connect to the left turn signal indicator light. Connect to the right turn signal indicator light.
14A	Light Blue	Left Dash Ind	
15B	Dark Blue	Right Dash Ind	
30	Tan	Gas Gauge	Connect to the signal or sender terminal of the fuel gauge. Connect to the signal or sender terminal of the oil pressure gauge.
31	Dark Blue	Oil Pressure Sender	
33	Tan	Brake Light	Connect to the ground side of the brake warning indicator light. Connect to the signal or sender terminal of the water temperature gauge.
35	Dark Green	Water Temp Sender	
39A	Pink	12V Ignition	Connect to the Ignition or power terminals of each gauge. An in line splice will be necessary to feed each gauge in the instrument cluster. Connect to the signal or sender terminal of the tachometer. Connect to the Ground terminals of each gauge and dash lamp. An in line splice will be necessary to feed each ground requirement in the instrument cluster.
121	White	Coil-Tach	
150	Black	Ground	connect to a good chassis ground or the VSS ground terminal on the speedometer. Mechanical speedometers do not require this connection. Connect to the VSS signal or sender terminal of the speedometer. Mechanical speedometers do not require this connection.
400	Yellow	VSS Ground	
401	Purple	VSS Signal	This wire will only be used when installing a stock instrument cluster. Connect to the Black with light green stripe wire when using a stock 1967 or 1968 Mustang instrument cluster. This is the accessory feed for the voltage reducer for certain stock gauges.
4E	Brown		

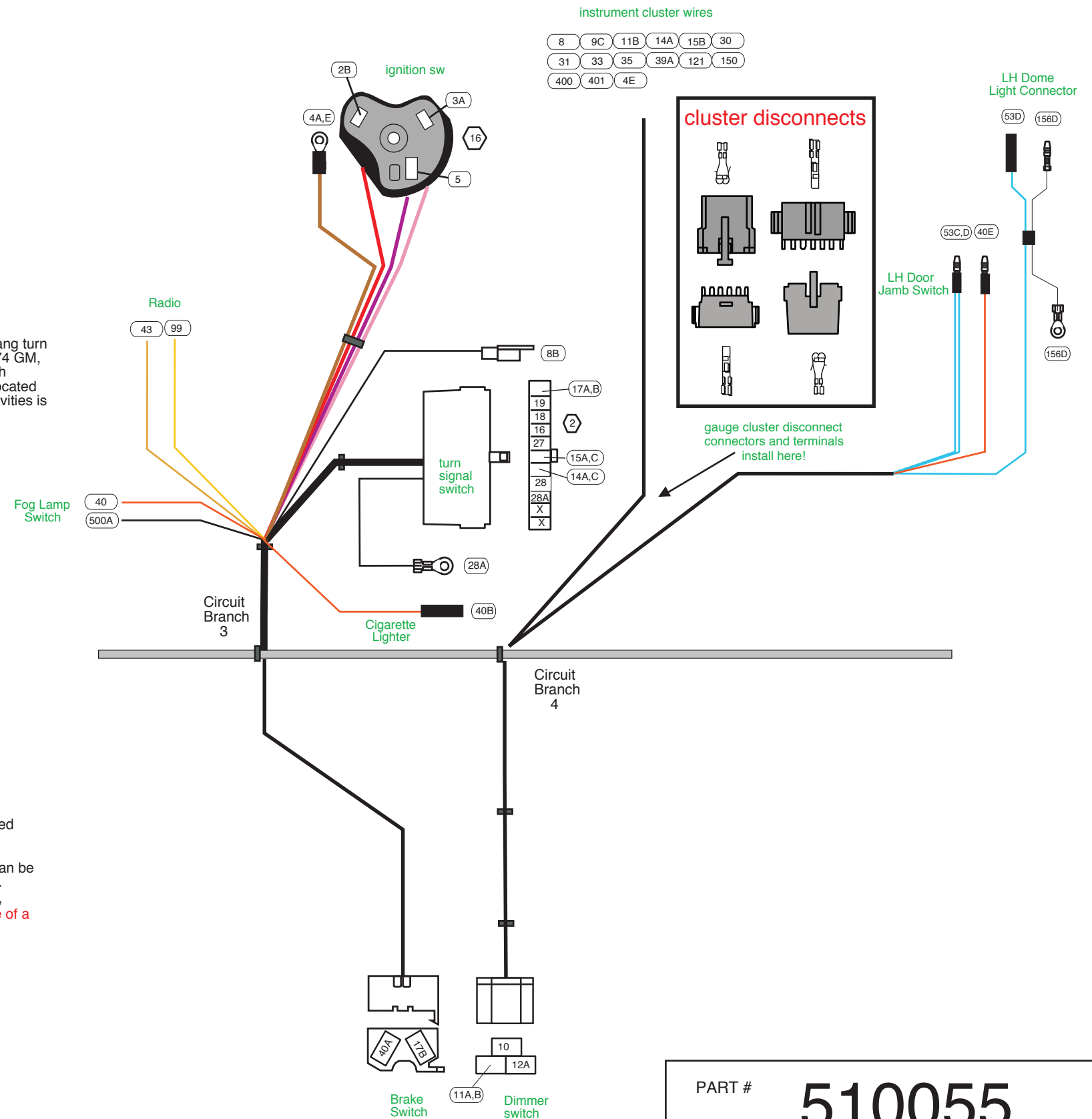

www.americanautowire.com 856-933-0801

PART # **510055**

DESCRIPTION:
**1967-68 Mustang
Classic Update Series Kit**

92968935 Rev 15.0 7/19/2017

TYPICAL BLADE TYPE GAUGE CONNECTIONS

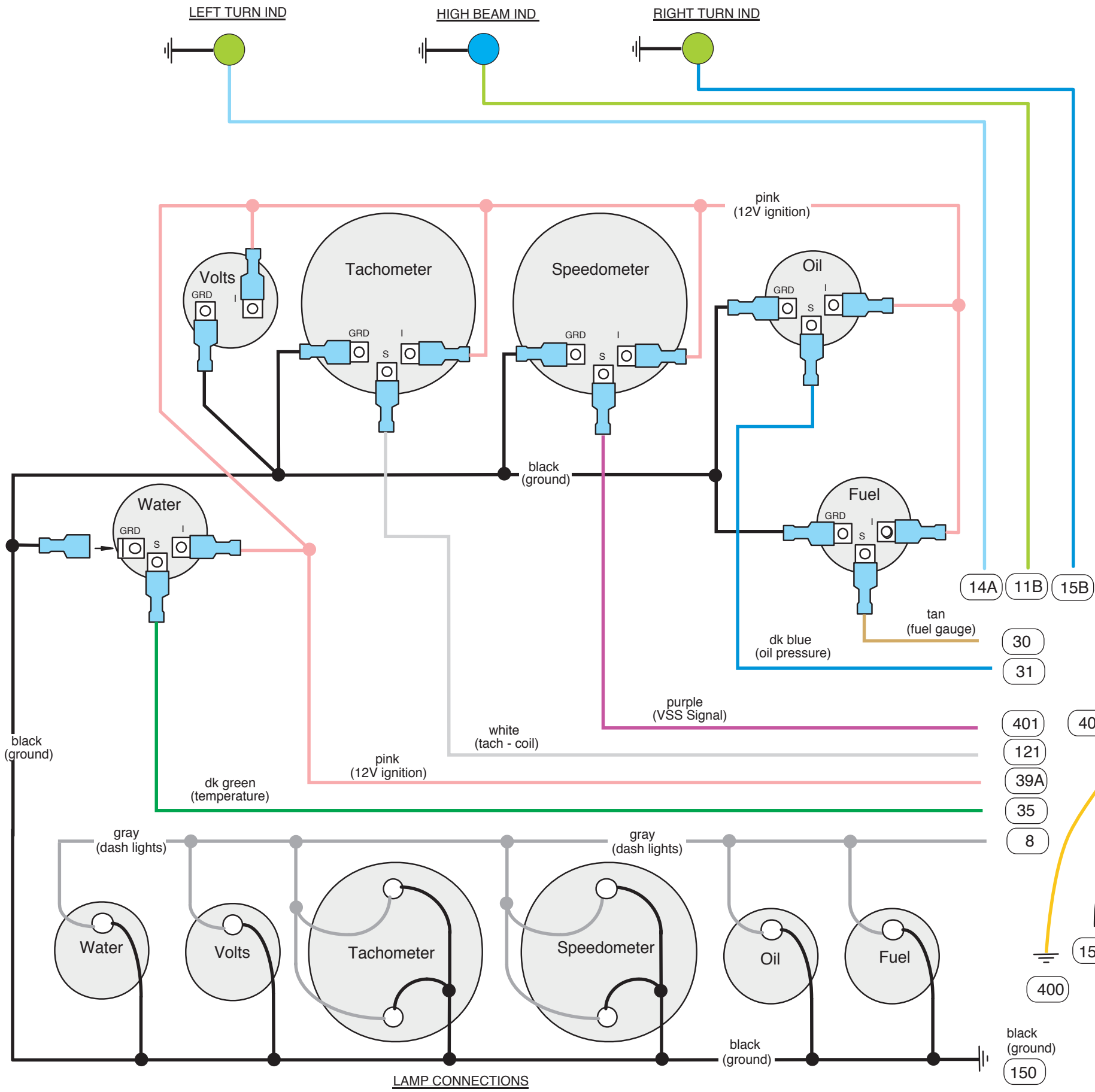

Typical 3 wire Autometer 5291 VSS connection

Note: This VSS requires a lead wire from the red wire to a 12 volt ignition source. This wire is not included in the kit.

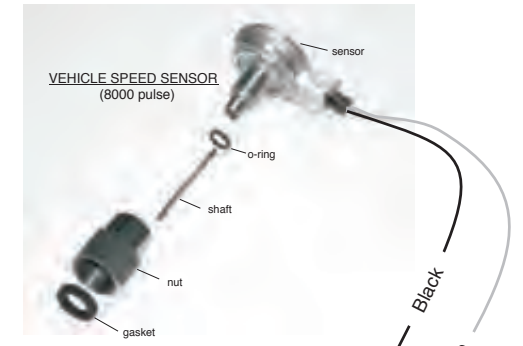

Typical 2 wire VSS connection

connect to 12 volt ignition source

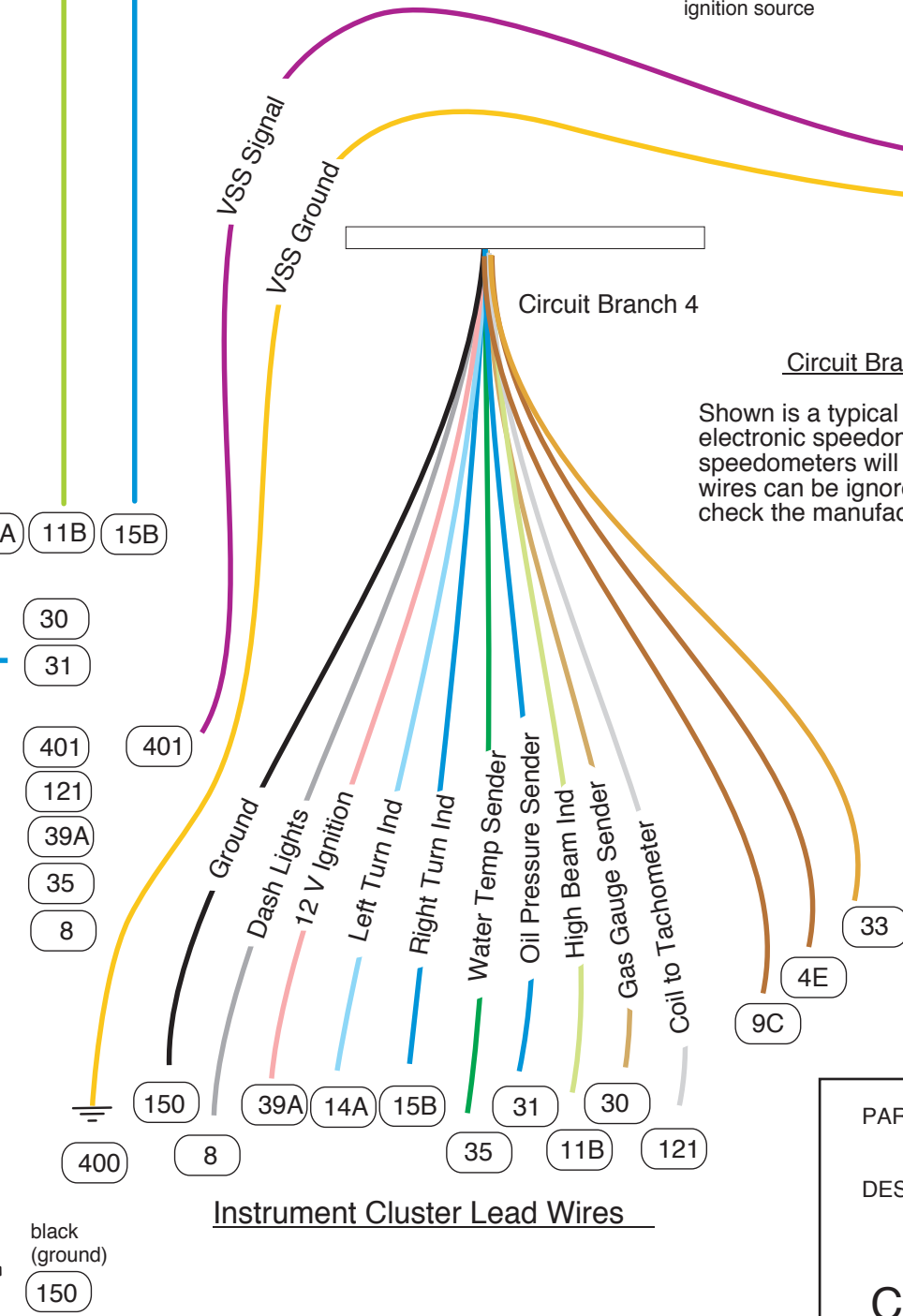

www.americanautowire.com 856-933-0801

PART # **510055**

DESCRIPTION: **1967-68 Mustang Classic Update Series Kit**

92968935 Rev 15.0 7/19/2017

Circuit Branch 5 - Under Dash connections

Wire #	Wire color	Printing	Procedure
Wiper Switch connections.			
93	White	Wiper Feed	Power input to wiper and washer switch connection. (This wire and terminal will attach to AAW harness number 510131, "Wiper Washer Harness", to complete your stock windshield wiper harness system. The instructions for the motor and pump connections, as well as the instructions on where to plug this wire into the "Wiper Washer Harness" can be found on instruction sheet number 510131.)
150	Black	Ground	Instrument Cluster ground. Connect to a good chassis ground.

Circuit Branch 6- Under Dash connections

Wire #	Wire color	Printing	Procedure
Rear Body Wire connections. This plugs into the Rear Body Kit 510052. See that sub-kit for specific installation instructions and circuit functions.			
Accessory Feed Wire connections.			
100	Tan	Accessory Fused	Accessory Fused power source.
103	Tan	Fuel pump	Connect to the power input terminal of a fuel pump relay.
104	Red	Power Locks	Connect to the power input of the power locks switch or any other battery powered accessory.
107	Pink	Ignition Fused	Ignition Fused power source.
116	Pink	Power Windows	Connect to the power input of the power windows switch or any other ignition powered accessory.
Headlight switch connector. The function of each wire is as follows:			
2F	Red	12V Battery	12 volt battery power to the switch.
9A,B,C	Brown	Park Lights	Power lead wires to the running light circuits.
44	Dark Green		Power lead wire to the dash lights .
10	Yellow	Dimmer Sw feed	Headlight power output to the Dimmer Switch.
40C,D,E	Orange	12V Battery Fused	Courtesy Light battery power
53A,B	Lt Blue	12V Ctsy Sw	Courtesy Light switched battery power

Courtesy light connector. Plug in your Left Hand under dash courtesy lamp assembly here. The function of each wire is as follows:			
53A,C	Lt Blue	12V Ctsy Sw	Courtesy Light power.
156A	White	Crtsy ground	Courtesy Light ground

Circuit Branch 7- Under Dash connections

Wire #	Wire color	Printing	Procedure
40H	Orange	12V Battery Fused	Connect to the glove box lamp assembly.

Circuit Branch 8- Under Dash connections

Wire #	Wire color	Printing	Procedure
Courtesy light connector. Plug in your Right Hand under dash courtesy lamp assembly here. The function of each wire is as follows:			
53E,J	Lt Blue	12V Ctsy Sw	Courtesy Light power.
156B	White	Crtsy ground	Courtesy Light ground

Circuit Branch 9- Under Dash connections

Wire #	Wire color	Printing	Procedure
Right Hand Dome Lamp Feed Wires.			
53E,F	Light Blue	12V Ctsy Sw	Connect to the Right Hand door jamb switch.
40J	Orange	12V Battery Fused	Connect to the Right Hand door jamb switch.
53F	Light Blue	12V Ctsy Sw	Connect to the Right rear dome lamp.
156C	White	Ctsy Ground	Connect the bullet terminal end to the right rear dome lamp. The ring terminal end must be connected to a good chassis ground.

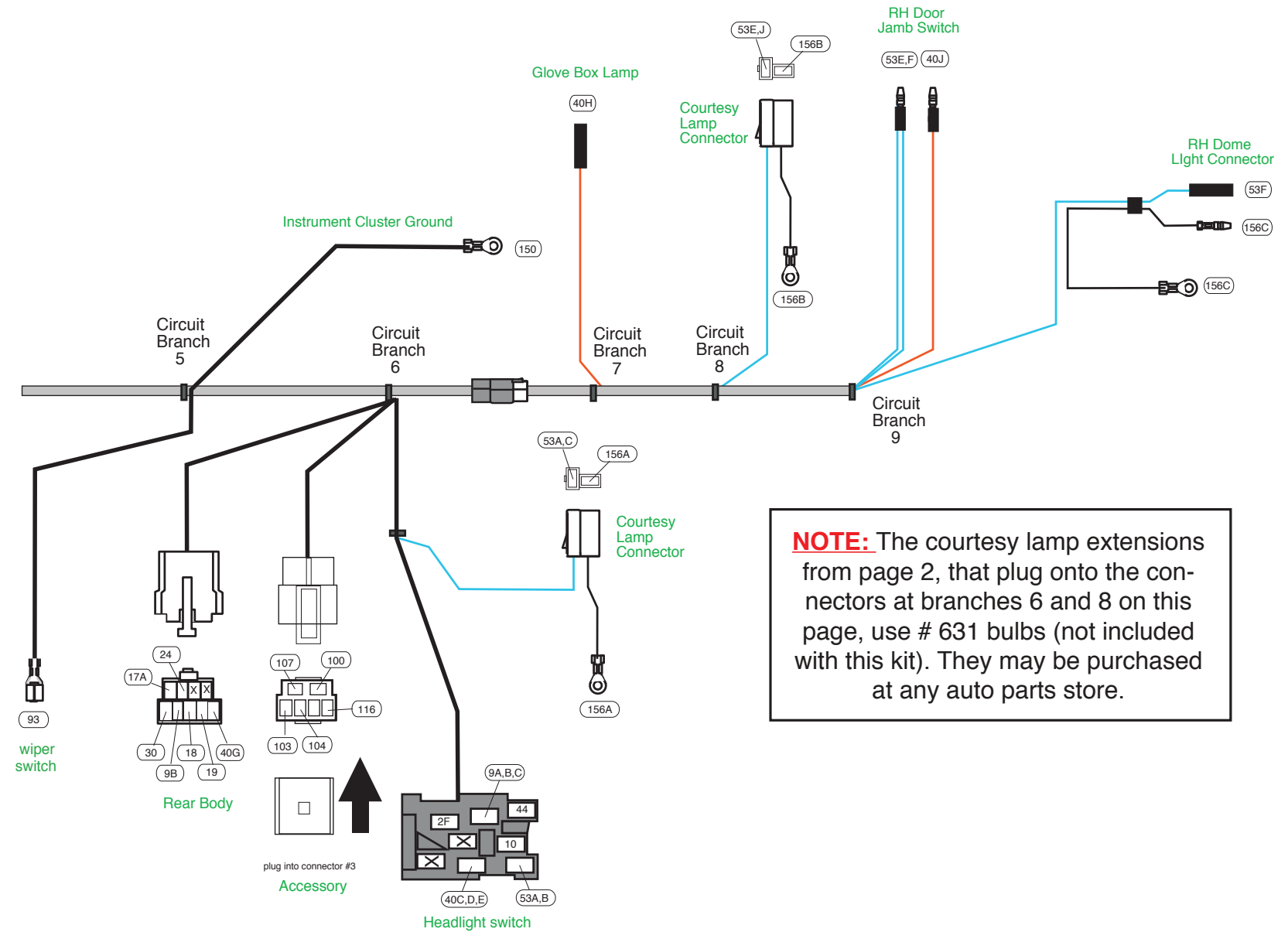

NOTE: The courtesy lamp extensions from page 2, that plug onto the connectors at branches 6 and 8 on this page, use # 631 bulbs (not included with this kit). They may be purchased at any auto parts store.



www.americanautowire.com 856-933-0801

PART # **510055**
 DESCRIPTION:
1967-68 Mustang Classic Update Series Kit
 92968935 Rev 15.0 7/19/2017

Engine Bay Side

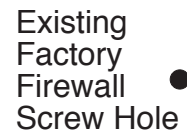
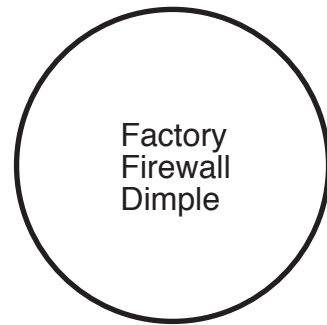
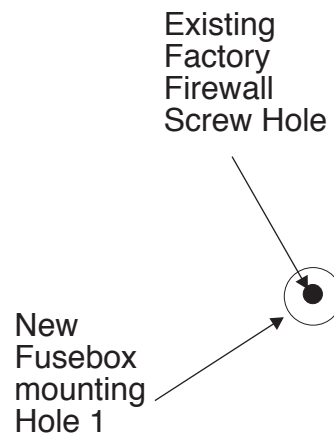
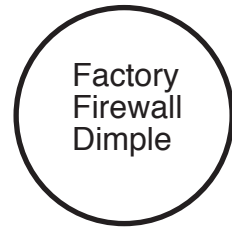
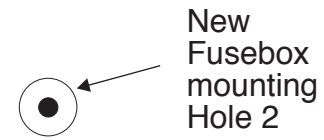

Fusebox Mounting Hole Template

Hole 2 needs to be drilled in the firewall for the new fuse box.

Position the template from either the engine bay side or the under dash side.

Locate the existing firewall screw hole that will set the center point for the new fuse box Hole 1. This hole is already the correct size for the new fuse box retention screw.

The template can then be used to set the center point to drill the 1/8 inch hole for the new fuse box Hole 2.

Under Dash Side

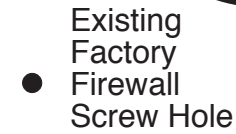
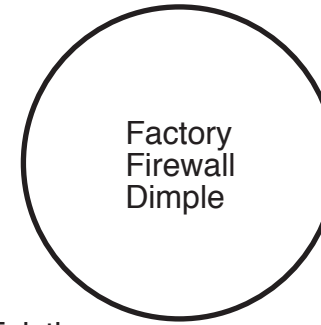
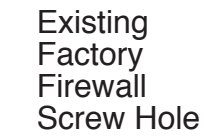
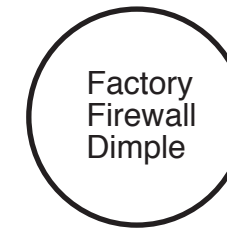
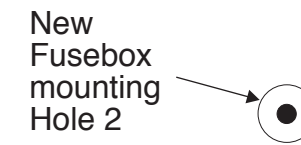

**American
Autowire**

www.americanautowire.com 856-933-0801

PART #

510055

DESCRIPTION:

1967-68 Mustang
Classic Update Series Kit

92968935 Rev 15.0 7/19/2017

Fuse Placement and Circuit Values

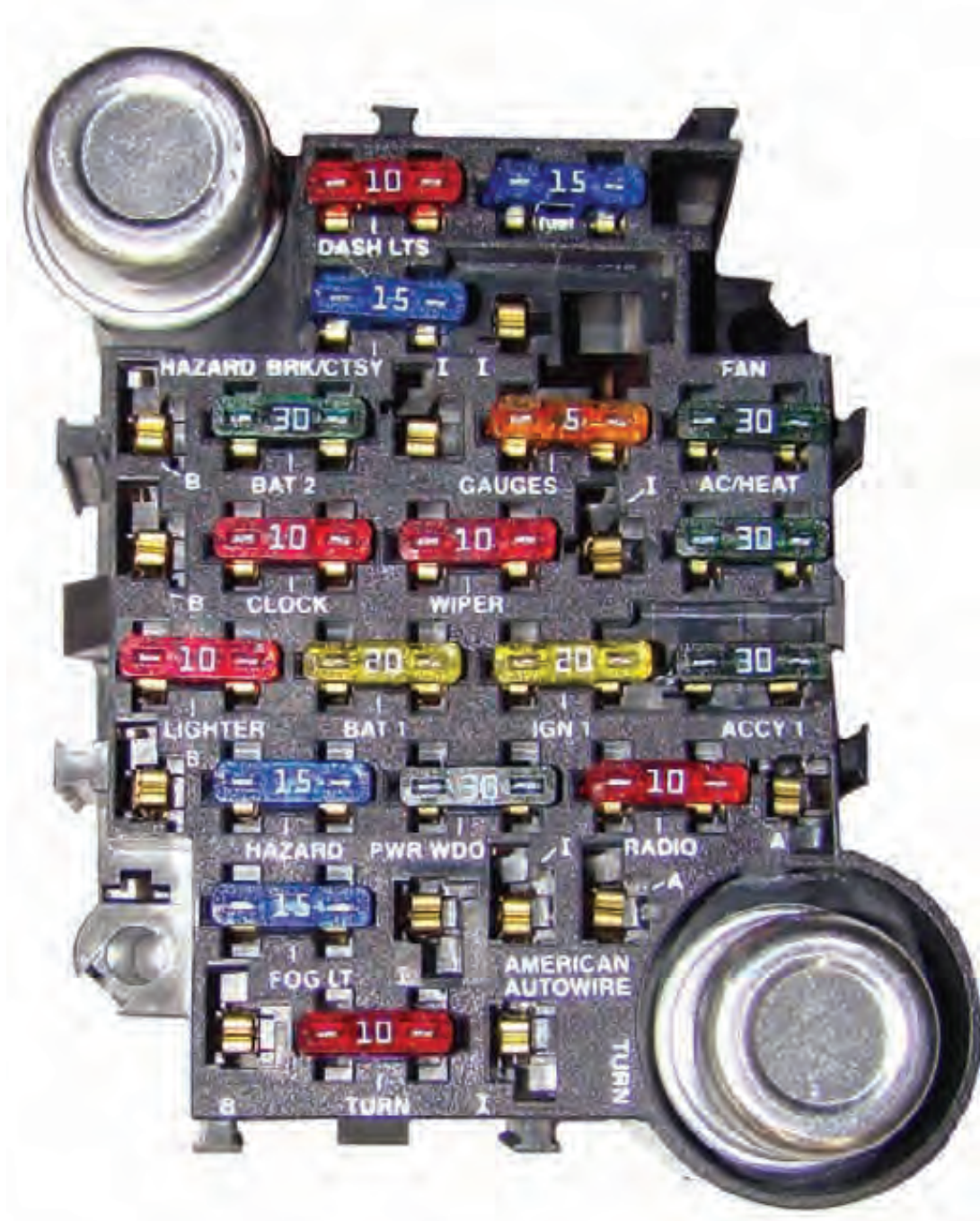

www.americanautowire.com 856-933-0801

PART # **510055**

DESCRIPTION:

**1967-68 Mustang
Classic Update Series Kit**

92968935 Rev 15.0 7/19/2017

Ignition switch, turn signal switch, radio, fog light switch, and cigar lighter wires, etc., all drop down on the right side of the steering column saddle.

Heat and AC feed, instrument cluster, headlight switch, accessory connections, rear body, wiper switch, dimmer switch, glove box, and courtesy light wires all route over the top of the steering column saddle to keep everything away from the wiper transmissions (moving linkage).

The front light wiring goes out through the stock hole in the firewall ahead of the headlight switch.

Harness routes down the firewall next to saddle and around the fresh air plenum.

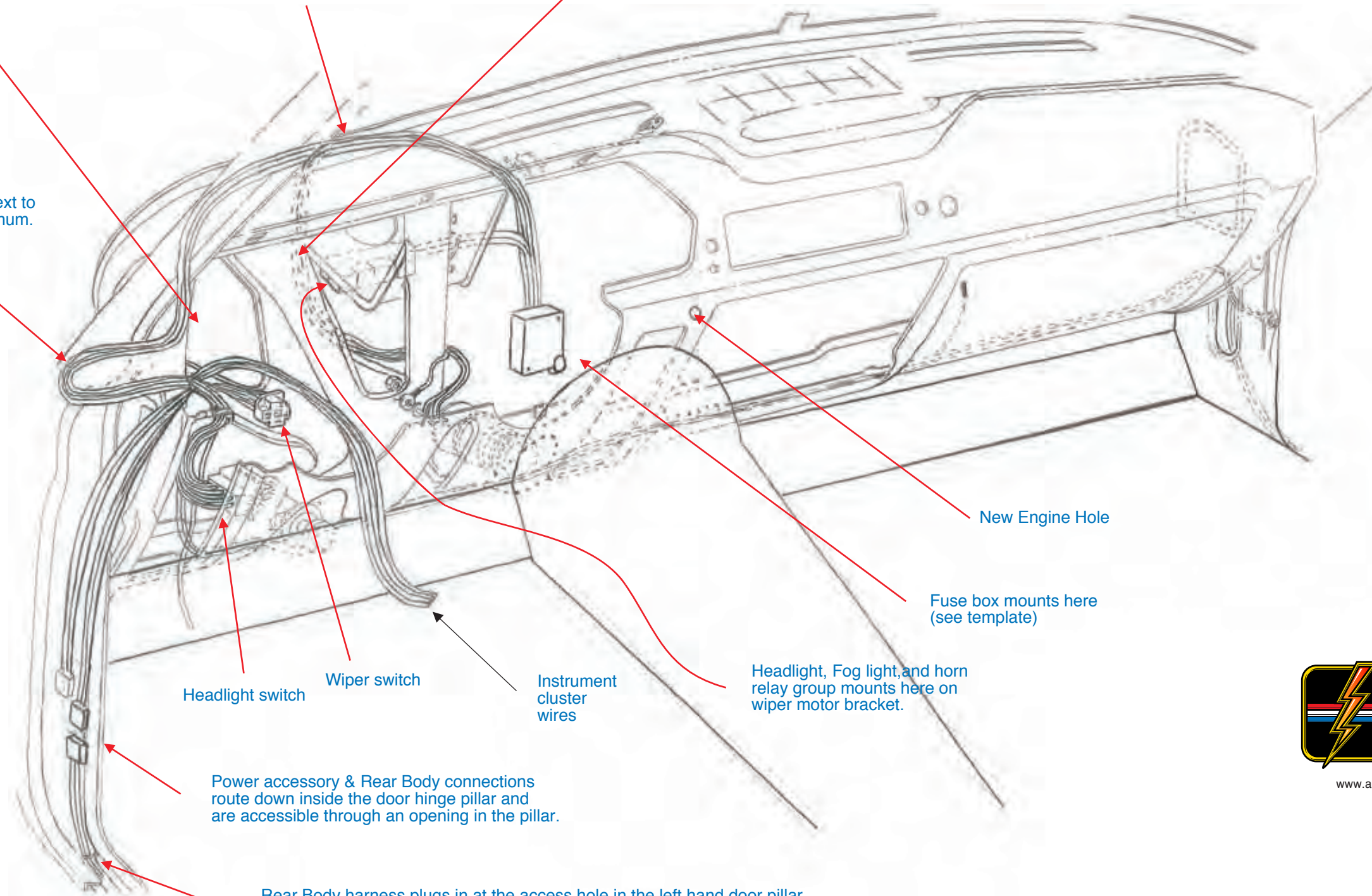

New Engine Hole

Fuse box mounts here (see template)

Headlight, Fog light, and horn relay group mounts here on wiper motor bracket.

Instrument cluster wires

Wiper switch

Headlight switch

Power accessory & Rear Body connections route down inside the door hinge pillar and are accessible through an opening in the pillar.

Rear Body harness plugs in at the access hole in the left hand door pillar and routes down through the channel, along the rocker sill, into the left quarter panel, and up over the wheel housing and into the trunk.



www.americanautowire.com 856-933-0801

PART # **510055**

DESCRIPTION:

**1967-68 Mustang
Classic Update Series Kit**

92968935 Rev 15.0 7/19/2017

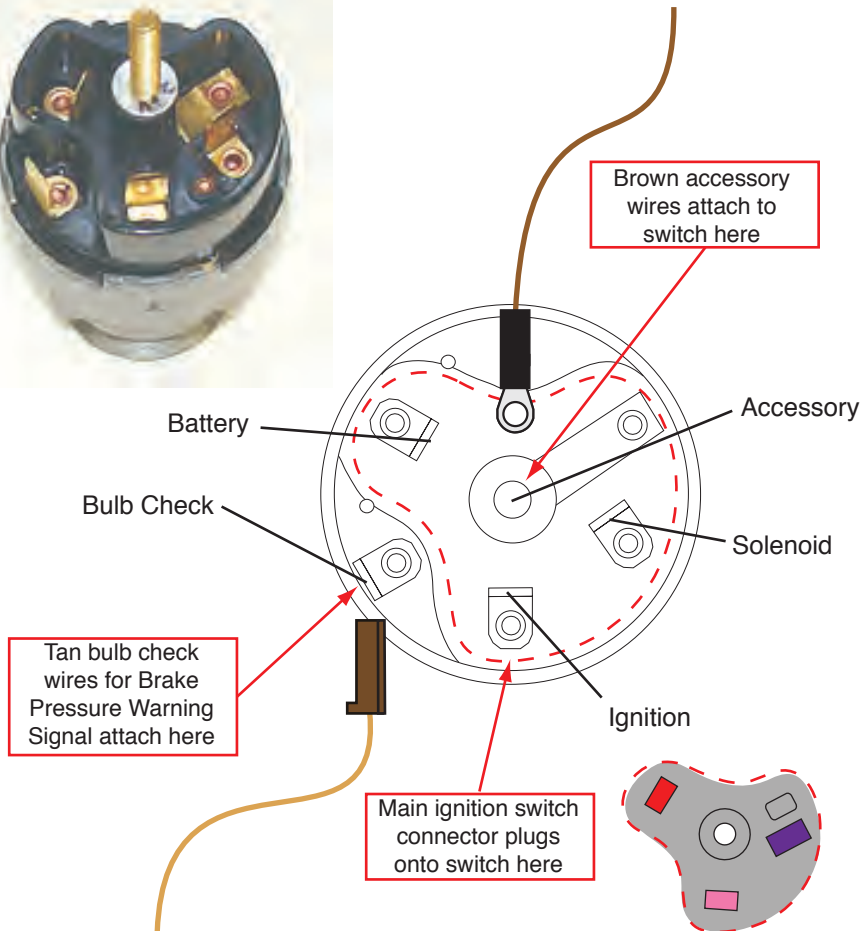

Watch our "Tech Tips" Video to help with your installation.
<http://www.youtube.com/watch?v=2KtpWvDRdFk>

PART #

510053

DESCRIPTION:

Ignition Switch
 Classic Update Series

92968930 instruction sheet rev 4.0 7/16/2018



www.americanautowire.com 856-933-0801

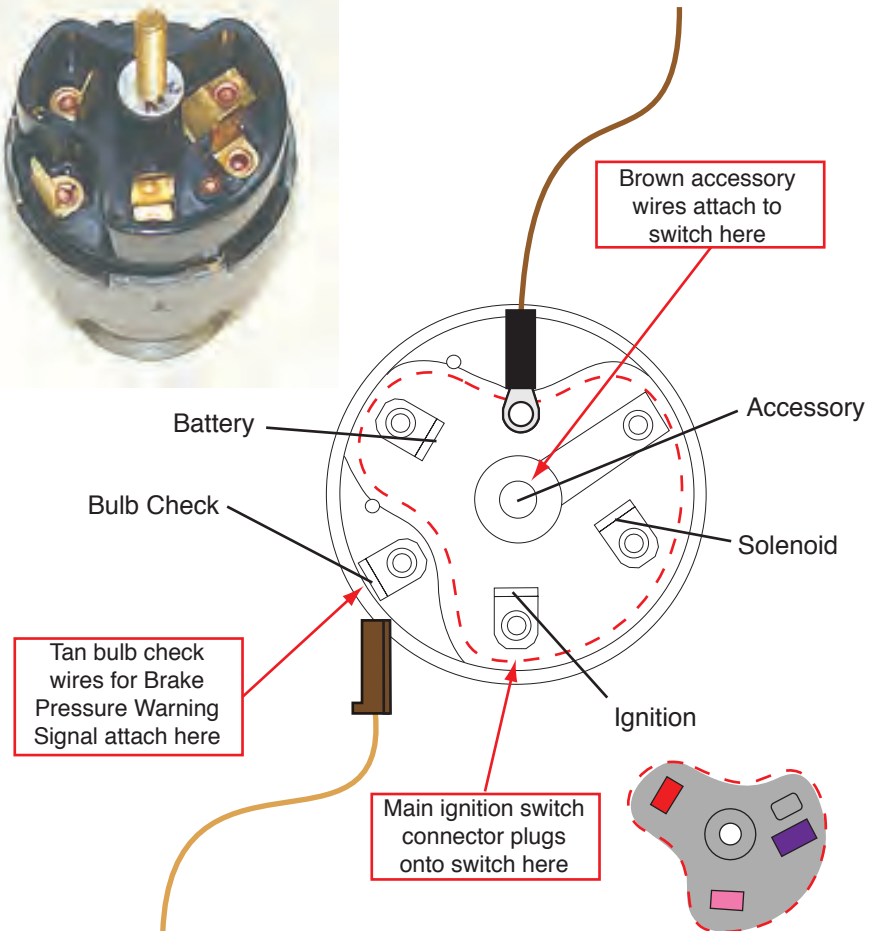

Watch our "Tech Tips" Video to help with your installation.
<http://www.youtube.com/watch?v=2KtpWvDRdFk>

PART #

510053

DESCRIPTION:

Ignition Switch
 Classic Update Series

92968930 instruction sheet rev 4.0 7/16/2018



www.americanautowire.com 856-933-0801

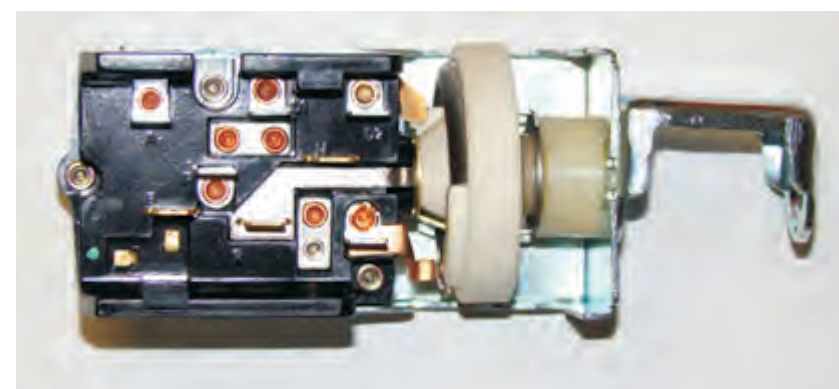
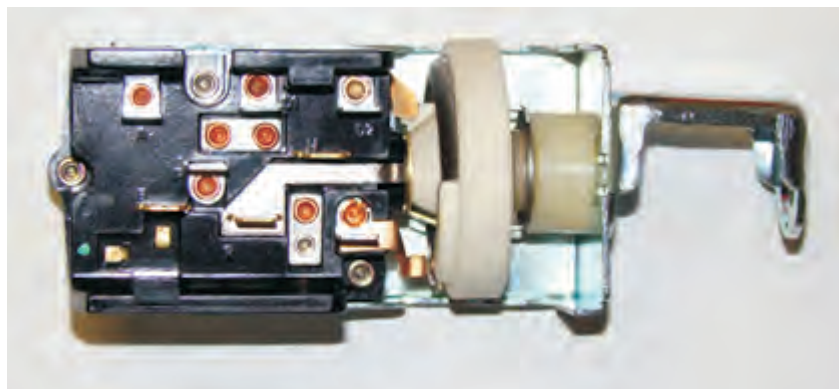
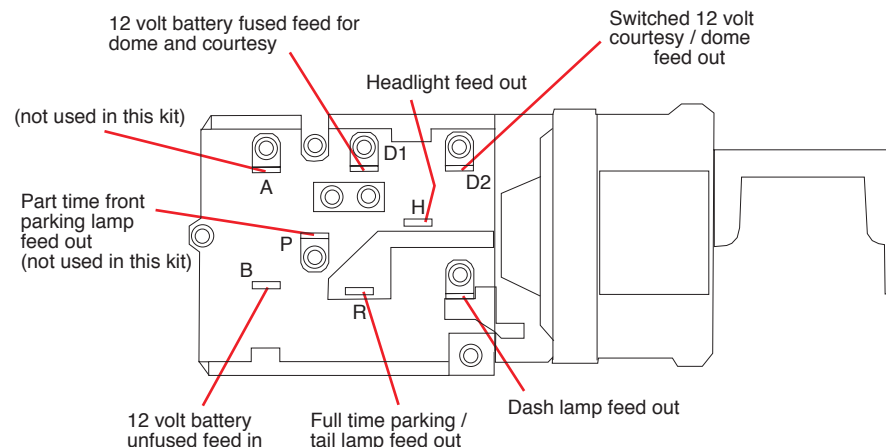
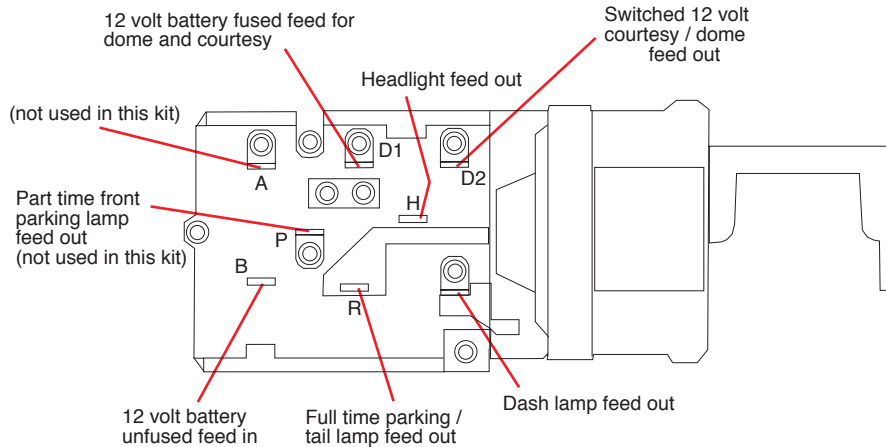

NOTE: Some early production 1964 1/2 Mustangs used a unique headlight switch assembly that utilized a shorter knob and shaft assembly than the later production 65 - 66 Mustang and 1965 Falcons used (3.63" vs. 3.90"). Your new AAW switch needs the later production style knob and shaft in order to operate. If you are using this switch on an early production 1964 1/2 Mustang, you will need to purchase the newer long style knob and shaft assembly from your favorite Mustang parts supplier as your original will be too short to operate this new switch.

NOTE: Some early production 1964 1/2 Mustangs used a unique headlight switch assembly that utilized a shorter knob and shaft assembly than the later production 65 - 66 Mustang and 1965 Falcons used (3.63" vs. 3.90"). Your new AAW switch needs the later production style knob and shaft in order to operate. If you are using this switch on an early production 1964 1/2 Mustang, you will need to purchase the newer long style knob and shaft assembly from your favorite Mustang parts supplier as your original will be too short to operate this new switch.



www.americanautowire.com 856-933-0801

PART #

510054

DESCRIPTION:

Headlight Switch
Various Ford Models
Classic Update Series

92968933 instruction sheet rev 3.0 2/12/2014



www.americanautowire.com 856-933-0801

PART #

510054

DESCRIPTION:

Headlight Switch
Various Ford Models
Classic Update Series

92968933 instruction sheet rev 3.0 2/12/2014

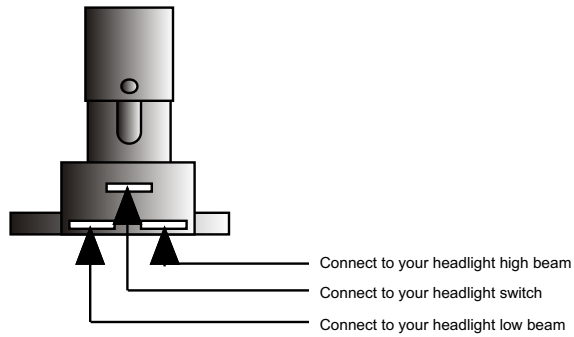

Connect the Dimmer Switch wires as shown above.

1. The top center terminal of the Dimmer Switch is connected to the Headlight switch.
2. The terminal on the right side is connected to your headlight high beam terminal.
3. The terminal on the left side is connected to your headlight low beam terminal.

another wiring product by...



150 Heller Pl #17 W Bellmawr, NJ 08031 856-933-0801

PART #

500042

DESCRIPTION:

DIMMER SWITCH

92964573 instruction sheet Rev 3.0 6/29/99

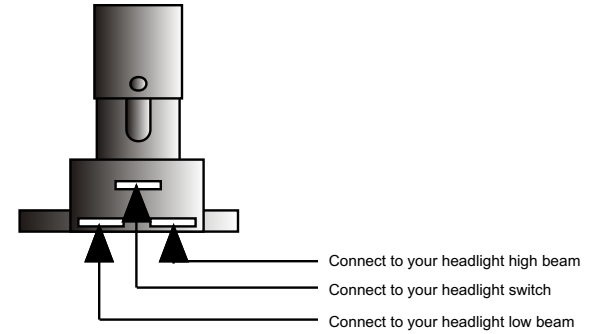

Connect the Dimmer Switch wires as shown above.

1. The top center terminal of the Dimmer Switch is connected to the Headlight switch.
2. The terminal on the right side is connected to your headlight high beam terminal.
3. The terminal on the left side is connected to your headlight low beam terminal.

another wiring product by...



150 Heller Pl #17 W Bellmawr, NJ 08031 856-933-0801

PART #

500042

DESCRIPTION:

DIMMER SWITCH

92964573 instruction sheet Rev 3.0 6/29/99

Table 'A' -
AAW Turn Signal Switch wires to
stock 1967-68 Mustang turn signal switch.

AAW Wire #	AAW Wire color	AAW Wire Printing	Ford Wire Color
14A	Light Blue	Left Front Turn	Green with white stripe
15B	Dark Blue	Right Front Turn	White with blue stripe.
16	Purple	Turn Switch Feed	Blue
17A	White	Brake Switch	Green
18	Yellow	Left Rear Turn	Green with orange stripe.
19	Dark Green	Right Rear Turn	Orange with blue stripe.
27	Brown	Turn Sw - Hazard	White with red stripe.
28	Black	Horn Relay Ground	Yellow
28A	Black	Horn Relay Ground	Blue with yellow stripe.

Note: Ford originally switched power to the horns through the steering column horn button. In this kit, ground is being switched through the original steering column switch to ground a horn relay which switches power to the horns.

Table 'B' -
AAW Instrument Cluster Kit wires to
stock 1967-68 Mustang instrument cluster wires.

AAW Wire #	AAW Wire color	AAW Wire Printing	Ford Wire Color
4E	Brown		Black with light green stripe This is the accessory feed for the voltage reducer for certain stock gauges.
8	Gray	Dash Lights	Blue with red stripe.
9C	Brown	Park Lights	Connect to any instrument cluster requiring a signal to dim a digital display. When using analog gauges, this wire will not be required.
11B	Light Green	Hi Beam Ind	Green with black stripe.
14A	Light Blue	Left Dash Ind	Green with white stripe.
15B	Dark Blue	Right Dash Ind	White with blue stripe.
30	Tan	Gas Gauge	Yellow with white stripe.
31	Dark Blue	Oil Pressure Sender	White with red stripe.
33	Tan	Brake Light	Purple with white stripe.
35	Dark Green	Water Temp Sender	Red with white stripe.
39A	Pink	12V Ignition	Red with yellow stripe
121	White	Coil-Tach	Sender terminal of the tachometer.
150	Black	Ground	Connect to the Ground terminals of each gauge and dash lamp. An in line splice is necessary to feed each ground requirement in the instrument cluster.
400	Yellow	VSS Ground	Connect to a good chassis ground or the VSS ground terminal on an electronic speedometer. Mechanical speedometers do not require this connection.
401	Purple	VSS Signal	Connect to the VSS pulse signal or sender terminal of the electronic speedometer. Mechanical speedometers do not require this connection.
99	Yellow	Radio Bat	Light blue with white stripe or light blue with black stripe. This is the 12 volt feed for the dash clock. If you are using a radio with a digital clock, it will be necessary to splice into this wire to create 2 leads. One to the dash clock, and one to the radio.

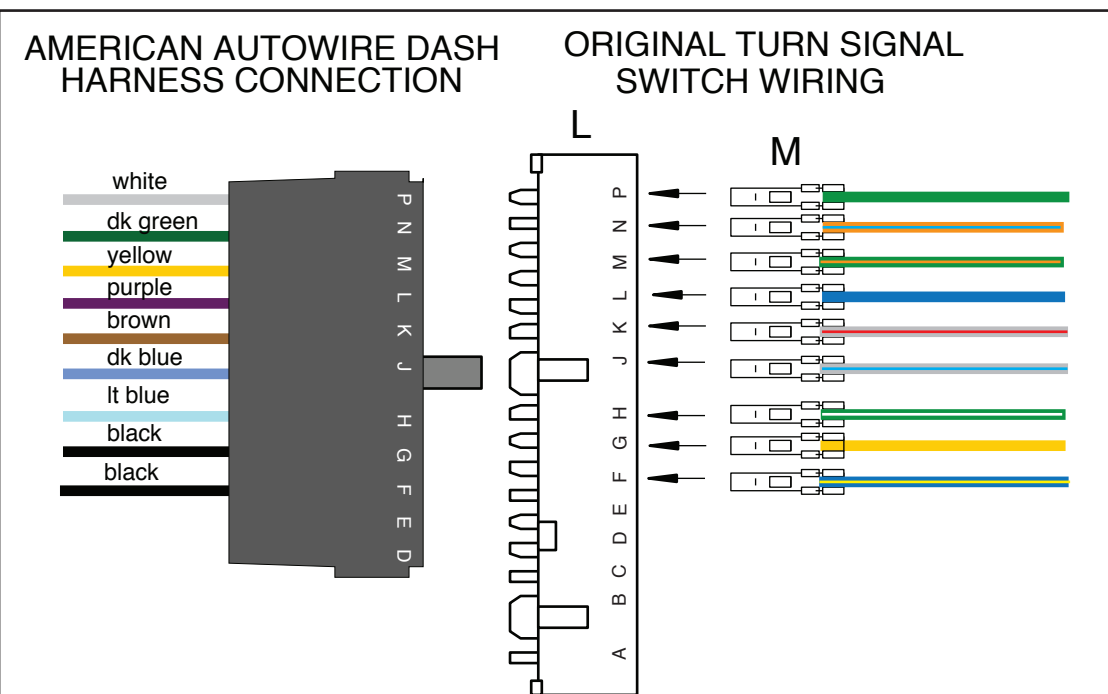

**DIAGRAM 'A' - AAW Turn
Signal Switch Wires to Stock
1967-68 Steering Columns.**



www.americanautowire.com 856-933-0801

PART # **510055**

DESCRIPTION:

**1967-68 Mustang
Classic Update Series Kit**

92968935 Rev 15.0 7/19/2017

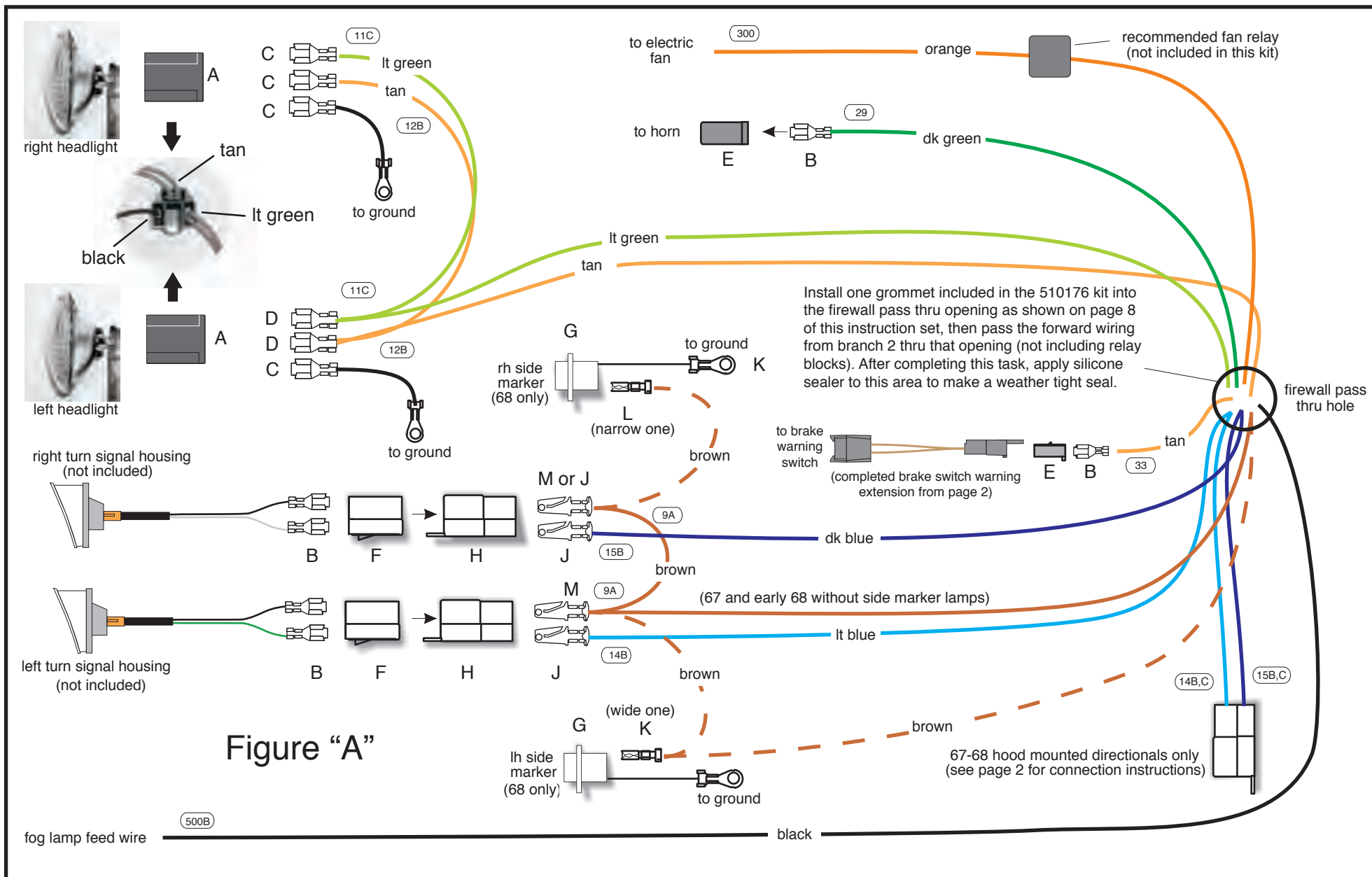

NOTE: The terminals and connectors listed on this page and denoted with **UPPER CASE LETTERS** to help you complete the various connections to your lamps, horns, switches, etc. can be found in your loose piece grommet and parts kit, P/N 510176.

The identifications, colors, and functions for all of the wires listed in "Figures A, B, and C" on this page can be found on page 3, branches 1 and 2 of this main instruction set. AAW suggests and recommends using both pages 3 and 10 to complete the installation of the forward lamp, main power, alternator power, and neutral safety connections.

AAW kits are all engineered to be used in conjunction with a high output, later model internally regulated, or one wire alternator. We do not suggest or support the use of a stock low amperage generator or alternator as they do not supply sufficient current to recharge the battery in a highly modified car such as this kit was designed for. AAW suggests a Ford Gen III type alternator as a good choice of an alternator to use. An adapter to complete the connection to this style alternator, our P/N 500802, may be purchased separately if needed. Contact our Sales Group or your favorite retailer to purchase this alternator adapter if needed.

Figure "A"

Main system power feed and alternator power feed connections.

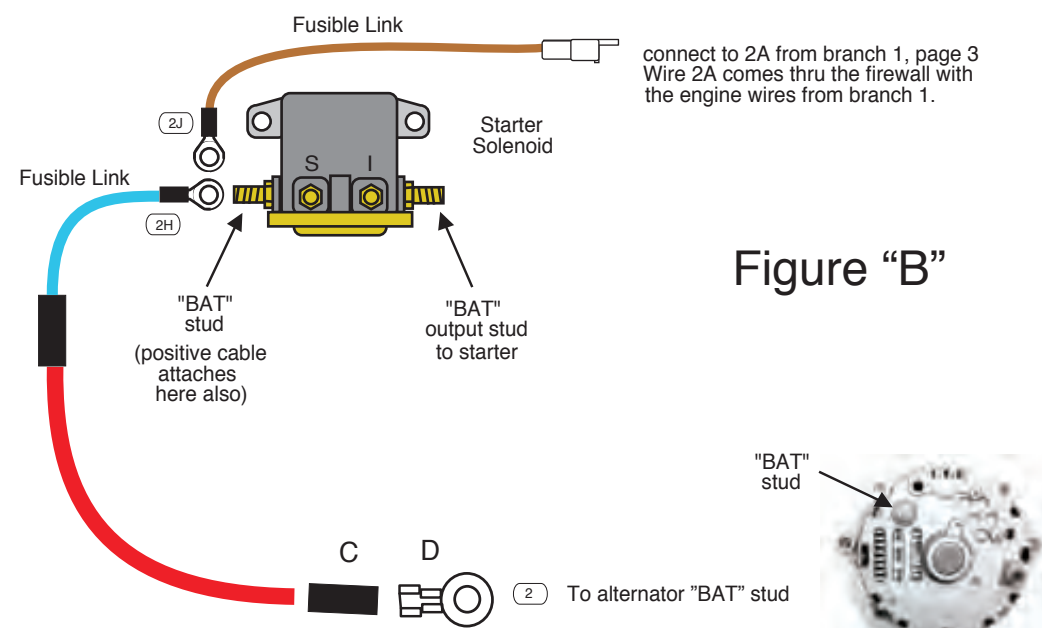
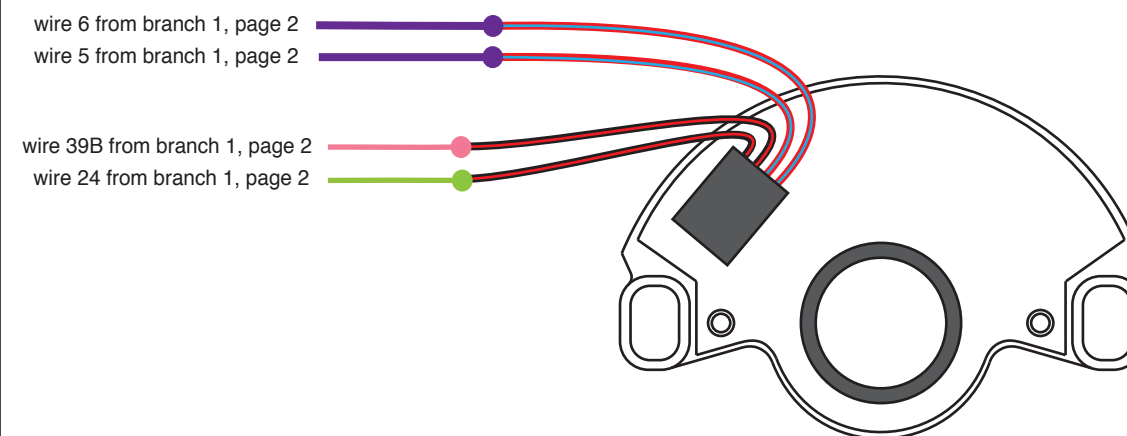

Figure "B"

Figure "C"
Shown is a typical NSS and Back Up Switch.



www.americanautowire.com 856-933-0801

PART # **510055**

DESCRIPTION:

**1967-68 Mustang
Classic Update Series Kit**

92968935 Rev 15.0 7/19/2017

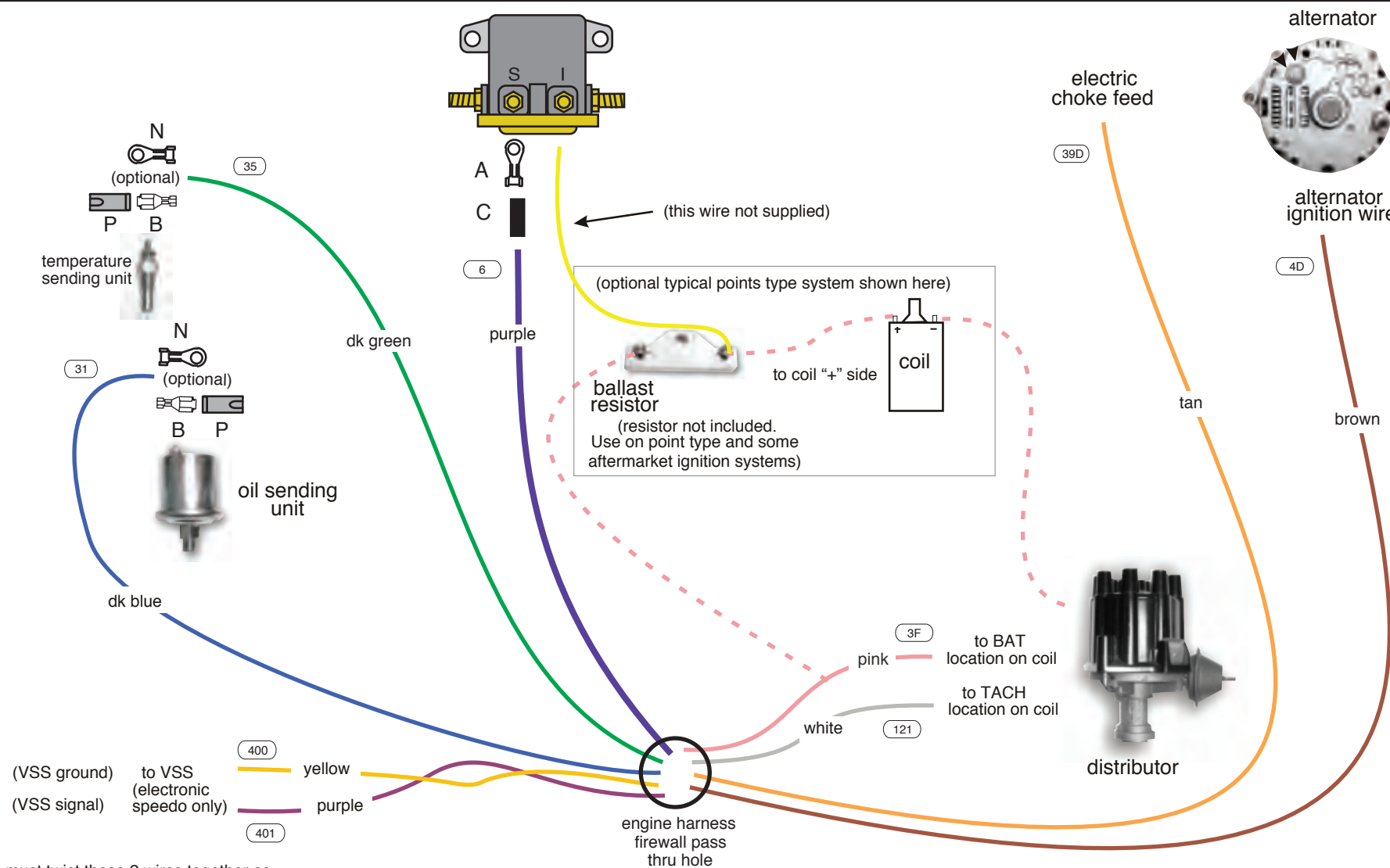

You must twist these 2 wires together as shown above to create a co-ax that will filter out any outside interference to the signal on your electronic speedometer.

Install one grommet included in the 510176 kit into the firewall pass thru opening as shown on page 8 of this instruction set, then pass the engine, alternator ignition, starter sloenoid, and main feed wiring from branch 1 thru this opening (except for the the heat and A/C Feed 50 wire). The neutral safety and B/U lamp wires are optional to run inside or outside the car depending on your application. For starter and main feed connections, refer to "Figure B" on page 10. After completing this task, apply silicone sealer to this area to make a weather tight seal.

Figure "D"

NOTE: The terminals and connectors listed on this page and denoted with **UPPER CASE LETTERS** to help you complete the various connections to your ignition, temp and oil senders, electric choke, starter solenoid, alternator regulator, etc. can be found in your loose piece grommet and parts kit, P/N 510176.

The identifications, colors, and functions for all of the wires listed in "Figures D, E, and F" on this page can be found on page 3, branch 1 of this main instruction set. AAW suggests and recommends using pages 3, 10, and 11 to complete the installation of the engine and alternator connections.

This AAW kit is engineered to work with most after-market manufacturer's heating and air conditioning systems. As such, we have provided a keyed 12-volt feed to use as the "OFF / ON" (AAW brown 50 wire) power source for whatever system you choose to purchase. The manufacturer will supply you with a harness for their system and instructions on how to connect it. In the event you are utilizing a stock heater system in your car, again we have provided the keyed 12-volt feed only. Figure E below depicts the typical stock 3 speed blower motor resistor and switch connections for the the heating system used in the 1967-68 Mustangs. AAW **DOES NOT** provide any of the other wiring from the switches to the resistors, or to the blower motor.

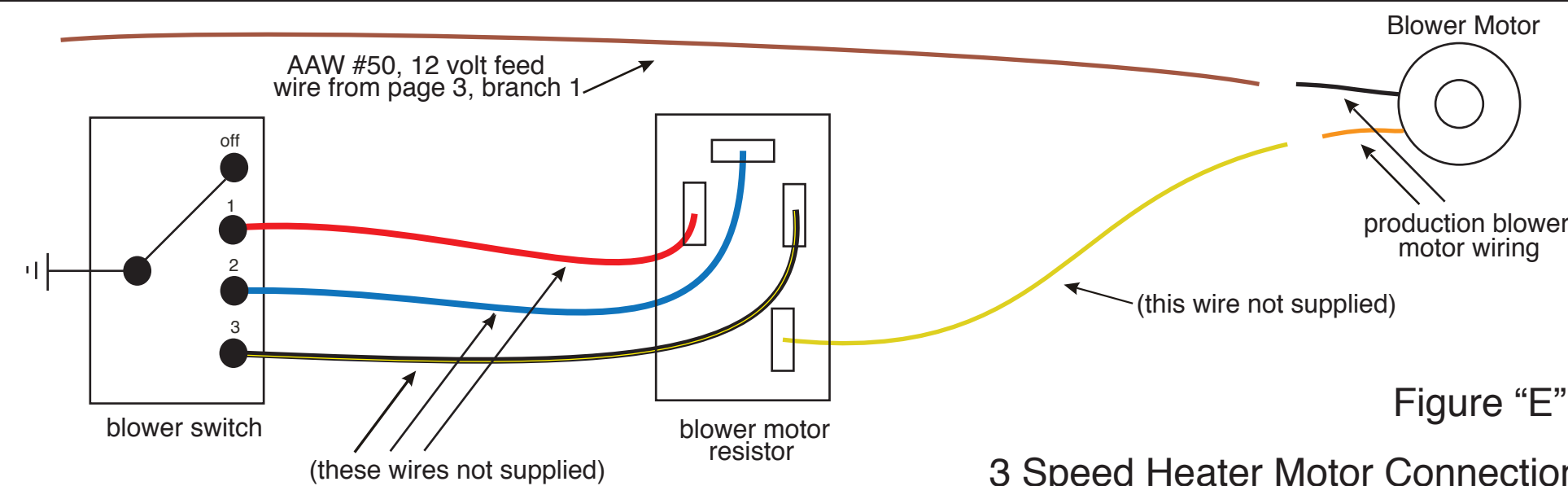

Figure "E"

3 Speed Heater Motor Connections



www.americanautowire.com 856-933-0801

PART # **510055**

DESCRIPTION:

**1967-68 Mustang
Classic Update Series Kit**

92968935 Rev 15.0 7/19/2017

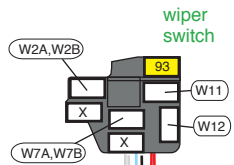

Plug in the white “wiper power feed” wire as shown on the main instruction set 92972103 (pages 6 and 22), to complete the wiper / washer circuit.

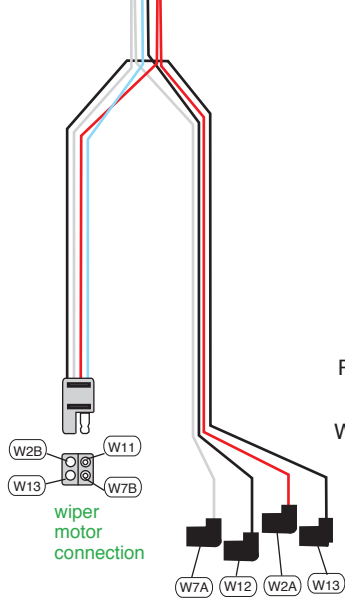

washer pump wires

Plug washer pump wires W7A, W12, W2A, and W13 onto washer pump switch coordinator as shown below.

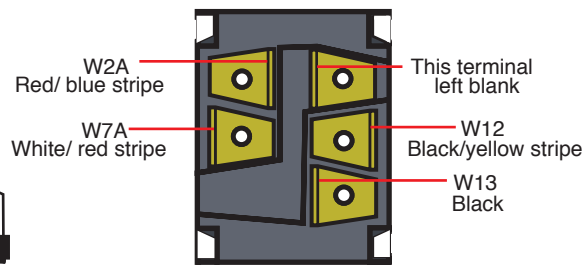

washer pump connections

- W2A Red/ blue stripe
- W2B Red/ blue stripe
- W7A White/ red stripe
- W7B White/ red stripe
- W11 Light blue
- W12 Black/ yellow stripe
- W13 Black

- Wiper switch to washer pump connection.
- Wiper switch to wiper motor connection.
- Wiper switch to washer pump connection.
- Wiper switch to wiper motor connection.
- Wiper switch to wiper motor connection.
- Wiper switch to washer pump connection.
- Wiper motor to washer pump connection.

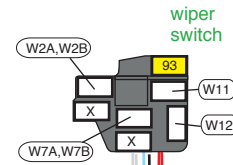

Plug in the white “wiper power feed” wire as shown on the main instruction set 92972103 (pages 6 and 22), to complete the wiper / washer circuit.

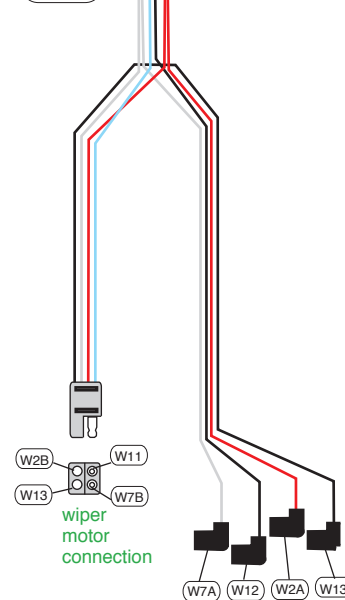

washer pump wires

Plug washer pump wires W7A, W12, W2A, and W13 onto washer pump switch coordinator as shown below.

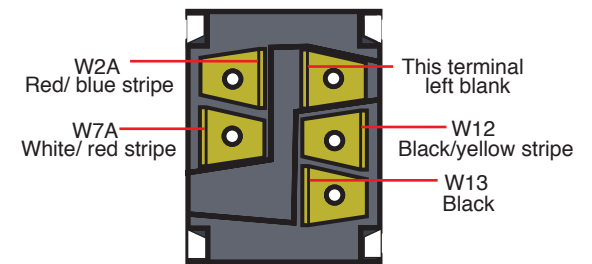

washer pump connections

- W2A Red/ blue stripe
- W2B Red/ blue stripe
- W7A White/ red stripe
- W7B White/ red stripe
- W11 Light blue
- W12 Black/ yellow stripe
- W13 Black

- Wiper switch to washer pump connection.
- Wiper switch to wiper motor connection.
- Wiper switch to washer pump connection.
- Wiper switch to wiper motor connection.
- Wiper switch to wiper motor connection.
- Wiper switch to washer pump connection.
- Wiper motor to washer pump connection.



150 Heller Pl #17 W Bellmawr, NJ 08031 856-933-0801

PART #

510131

bag N

DESCRIPTION:

Washer Wiper Wiring
1967-68 Mustang
Classic Update Series

92969243 instruction sheet rev 4.0 6/25/2018



150 Heller Pl #17 W Bellmawr, NJ 08031 856-933-0801

PART #

510131

bag N

DESCRIPTION:

Washer Wiper Wiring
1967-68 Mustang
Classic Update Series

92969243 instruction sheet rev 4.0 6/25/2018

USE THIS SHEET FOR ALL 1967-70 MUSTANG CARS

Note: You have been provided with terminals C and connectors E to complete the pigtail extensions for your stop/tail and back up lamps as shown on sheet 1.

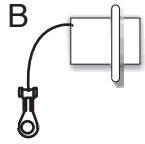
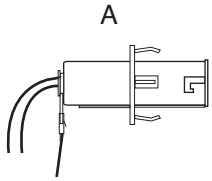

Brown

Rear running lamps

(1964-68 without side markers lamps) Route this wire to the LH tail lamp, cut to length, take that wire and the cut off portion, double them together with terminal N, and install into connector F as shown on sheet 1. Take the other end of the cut off portion and route to your tag light, cut to length, take that wire and double it with the cut off portion in terminal P and install into sleeve Q (your stock tag lamp assembly will plug directly into this connection). Take the other end of the cutoff portion and route to your RH tail lamp, cut to length, install terminal J and plug into connector F as shown on sheet 1.

(1968-70 with side markers lamps) Route this wire to the LH side marker lamp, cut to length, take that wire and the cut off portion, double them together with terminal D, and plug into lamp socket pigtail B as shown on sheet 1. Take the other end of the cut off portion and route it to your LH tail lamp, cut to length, take that wire and the cut off portion, double them together with terminal N, and install into connector F as shown on sheet 1. Take the other end of the cut off portion and route it to your tag light, cut to length, take that wire and double it with the cut off portion in terminal P and install into sleeve Q (your stock tag lamp assembly will plug directly into this connection). Take the other end of the cutoff portion and route it to your RH tail lamp, cut to length, take that wire and the cut off portion, double them together with terminal N, and install into connector F as shown on sheet 1. Take the remaining wire, route it to the RH side marker lamp, cut to length, install terminal G and plug into lamp socket pigtail B as shown on sheet 1.

Black

Grounds

There are six (6) ground wires in this kit. There are 2 wires installed onto the tail lamp sockets, 2 wires installed into the back up lamp connections, and 2 wires installed into the side marker lamp sockets. After installing the tail lamp and backup lamp extensions, bring your black ground wires to a common area, trim all 4 to length, install terminal U, and ground to the body of the car inside the trunk. The last 2 wires installed into your side marker lamp sockets get grounded to the body inside the trunk of the car.

Yellow

LH Stop / Turn

Route this wire to the LH tail lamp, cut to length, install terminal J, and plug into connector F as shown on sheet 1.

Dark Green

RH Stop / Turn

Route this wire to the RH tail lamp, cut to length, install terminal J, and plug into connector F as shown on sheet 1.

Light Green

Back Up Lamp Feed

Route this wire to the LH backup lamp, cut to length, take that wire and the cut off portion, double them together with terminal N, and install into connector F with the black ground wire as shown on sheet 1. Take the other end of the cutoff portion and route to your RH backup lamp, cut to length, install terminal J and plug into the other connector F with the black ground wire.

Light Blue

Third Brake Light

If you are using this option, insert the light blue "third brake light" wire into connector B maintaining color continuity with the dash harness rear body plug. Route the other end to your third brake light as needed.

Orange

12V Battery Fused

This wire can be used as a trunk light feed or 12 volt battery power if you are running LED tail lamps. If you are using this option, insert the orange "12v battery fused" wire into connector B maintaining color continuity with the dash harness rear body plug. Route the other end to your trunk area as needed.

Tan

Fuel Tank Feed

Take this wire, route it down through the trunk floor and over to the fuel tank sender, cut to length, slide on sleeve "L", and install terminal H. Install this assembled ring onto the fuel tank sender to complete this circuit.

Classic Update Series



(12 volt "Battery" only used with LED tail lamp or optional trunk lamp)

Plug into connector "B" and maintain continuity with dash harness rear body plug.

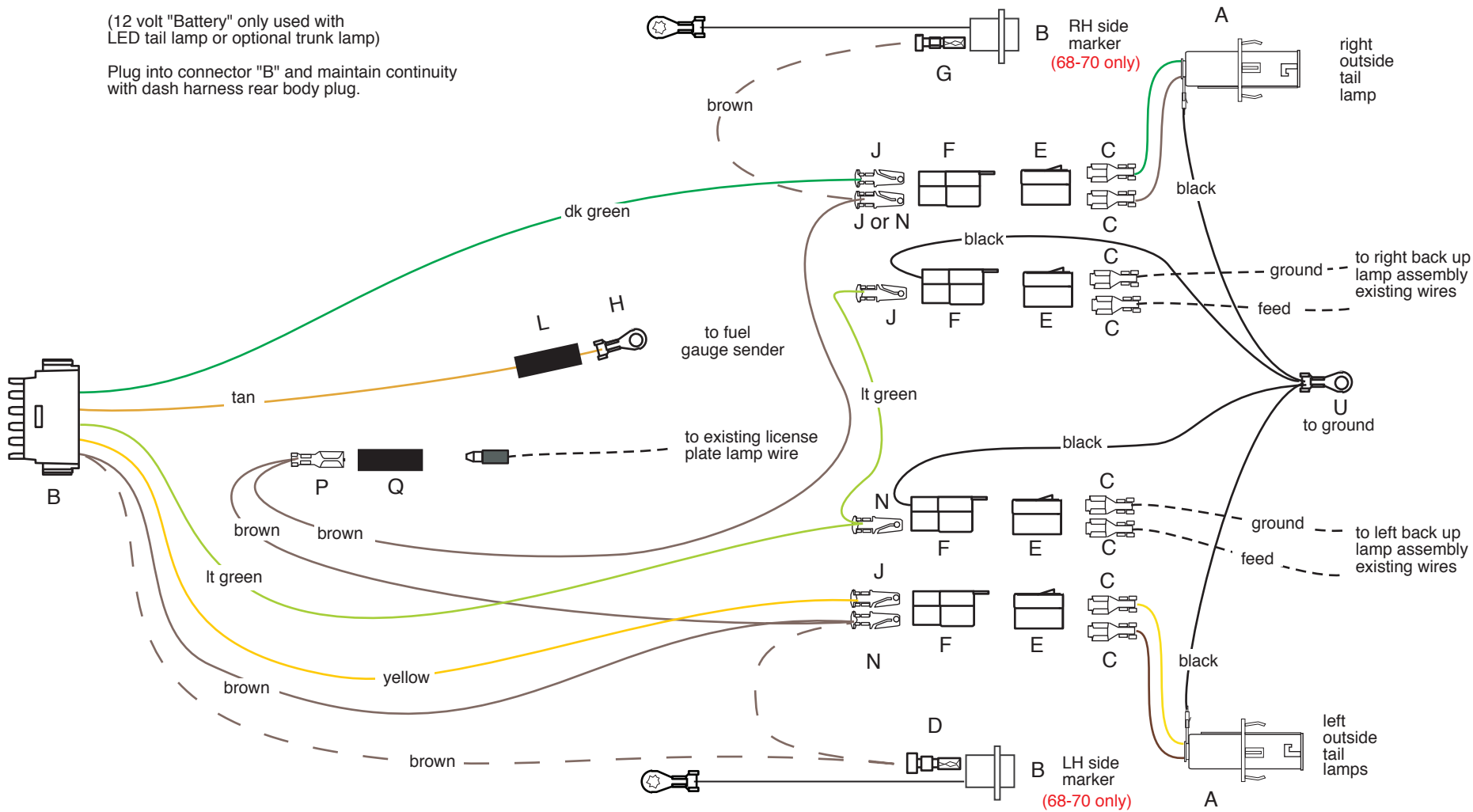

(Third brake light - only used when needed)

Plug into connector "B" and maintain continuity with dash harness rear body plug.



**American
Autowire**

www.americanautowire.com 856-933-0801

Classic Update Series
1967-70
Mustang

bag
M

REAR BODY KIT

510052

92968924 Rev 2.0 5/15/2014