

**NOTE:** If the fuse panel on your 510333 '67-'68 Chevy truck kit **HAS** a sticker like the photo at the left, you have the second design harness and your instructions are listed below and follow this page.

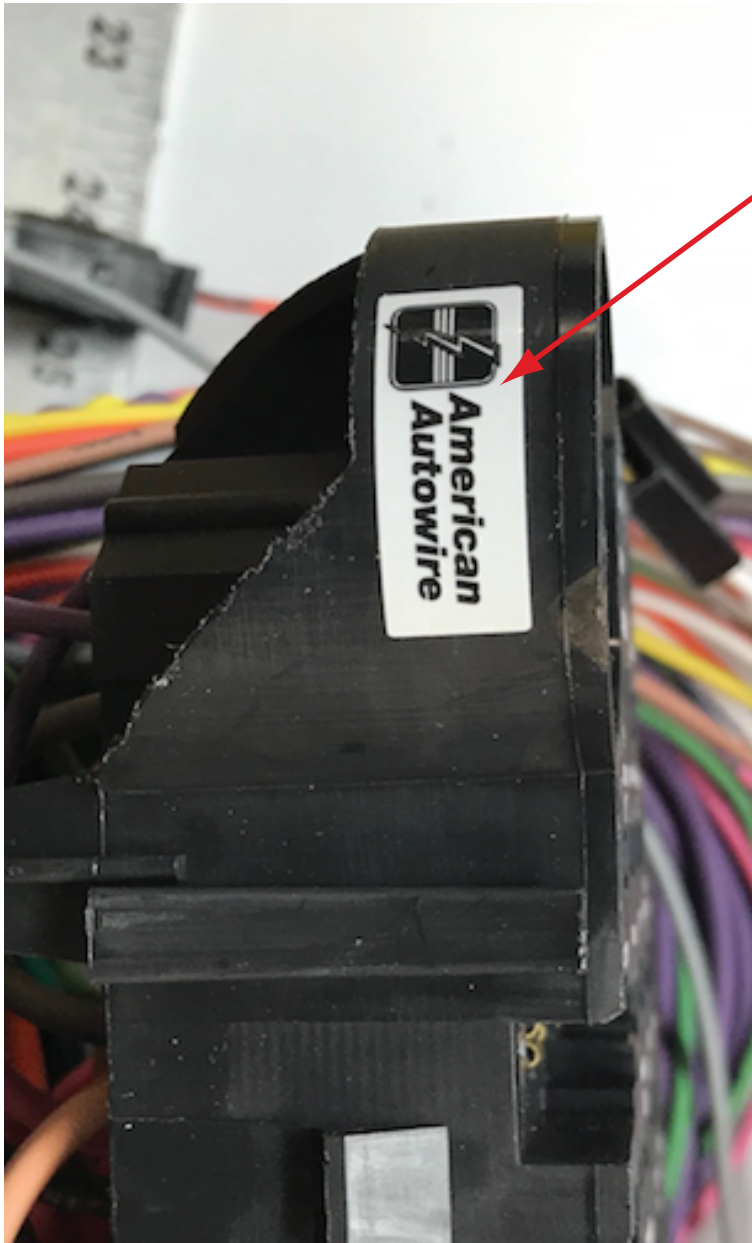

<u>Number</u>	<u>Description</u>
500332	Headlight Switch
500707	Fuse, Relay, and Flasher kit
500708	Courtesy Light kit
500919	Practice Terminal Crimping Set
510495	Dash Harness kit
510496	Engine Wiring Kit
510497	Front Light Wiring kit
510498	Instrument Cluster wiring kit
510095	Rear Body Wiring kit
510102	Ignition Switch
510103	Ignition Switch Lock Cylinder and Keys
510104	Floor Dimmer Switch
510334	1967-68 Chevy Truck Jumper Harness Kit
510730	VSS Connection Kit
510476	Alternator and Main Power Connection kit
92968980	Firewall Modification Template
92972498	Kit Introduction Instruction Sheet
92972500	Instructions for 1967-68 Chevy Truck
92972501	Warning Sheet



www.americanautowire.com 856-933-0801

**'67-'68 Chevy Truck  
Second Design  
Instructions**  
92972643 rev. 0.0 12/1/2019



## WARNING:

Validate the kit contents with the component list included on page 2 of this sheet before proceeding. This kit is intended to be used in a modified vehicle. Please read this sheet thoroughly and be sure that you understand everything explained on it prior to opening any of the enclosed packages, or before attempting to install any of the components. Once this kit has been opened or a component installed, the kit is not returnable.

1. This kit should typically be used in a **MODIFIED** application only.
2. This kit supports the use of factory heater systems and aftermarket heater and A/C systems. The kit supplies power to a factory A/C control head but **DOES NOT** include the actual A/C harness for an original factory A/C vehicle. Factory original A/C harnesses are available under our Factory Fit product line as they are self contained harnesses made to fit and work with the stock A/C component configuration.
3. This kit supports the use of a high current self-exciting 1-wire alternator or other style internally regulated alternators. An adapter may be necessary in some applications. The use of a stock, low amperage alternator is seriously discouraged as they cannot handle the higher current requirements of updated ignition systems, electric fans, aftermarket A/C systems, stereo systems, air ride suspensions, and other power hungry accessories and will ultimately create performance issues with the system.
4. This kit **WILL NOT** support the use of a factory ammeter. All AAW kits are engineered to supply the optimum charge to the battery. To achieve this performance, we route our 6ga. charge wire directly from the alternator output charge terminal to the starter battery terminal. Due to the path of the charge being altered from the stock configuration, the gauge can no longer see a charge vs. a discharge, so it will not work properly. When ammeters were originally used, most generator or alternator current outputs were rated at a maximum of about 25-60 amps. Modified cars being built today typically utilize a 100 amp or higher output alternator. With these higher current units, ammeters, generally speaking, become a safety hazard. Ammeters are usually wired in parallel to the charging circuit, are typically unfused, and can short very easily causing a fire. A voltmeter is recommended as a good alternative.
5. This kit **IS NOT** set up with a resistance wire for a standard, points type ignition system. It is wired with a full 12 volt primary ignition feed that is hot in the run position. Primary ignition voltage in the starting position is handled via a full 12 volt bypass wire. Our system will support HEI, MSD, other electronic ignition systems, as well as most all computerized Fuel Injection systems. If you wish to run a points type system, there are illustrations on the engine connection pages to do so. Extra parts (ballist resistor) that are not included in this kit will be required to complete that operation.



## 510333 - Classic Update Series Kit 1967-68 Chevrolet Truck

This kit contains the following components:

<u>Bag</u>	<u>Part Number</u>	<u>Description</u>	<u>Quantity</u>
	500332	Headlight Switch	1
	500707	Fuse, Relay, and Flasher kit	1
N	500708	Courtesy Light kit	1
	500919	Practice Terminal Crimping Set	1
G	510495	Dash Harness kit	1
J	510496	Engine Wiring Kit	1
L	510497	Front Light Wiring kit	1
H	510498	Instrument Cluster wiring kit	1
M	510095	Rear Body Wiring kit	1
	510102	Ignition Switch	1
	510103	Ignition Switch Lock Cylinder and Keys	1
	510104	Floor Dimmer Switch	1
	510334	1967-68 Chevy Truck Jumper Harness Kit	1
V	510730	VSS Connection Kit	1
Z	510476	Alternator and Main Connection kit	1
	92968980	Firewall Modification Template	1
	92972498	Kit Introduction Instruction Sheet	1
	92972500	Instruction Sheet 1967-68 Chevy Truck	1
	92972501	Warning Sheet	1

Validate the kit contents with this component list. If there are any discrepancies with incorrect or missing parts, stop your installation and notify the supplier you purchased the kit from before proceeding.



www.americanautowire.com 856-933-0801

# 510333

92972501 instruction sheet Rev 0.0 8/1/2019

# Classic Update Series

1969-72 Chevy & GMC Truck

## START HERE !

PLEASE READ THIS BEFORE STARTING INSTALLATION !

This wiring kit is designed for ease of installation. Please read the guidelines below, BEFORE STARTING your installation, to guarantee a successful job! Use an appropriate crimping tool which folds the crimp wings on the terminals as shown below. Top quality crimping tools are available from American Autowire or American Autowire authorized dealers.

**NOTE: ALL TERMINALS THAT YOU INSTALL SHOULD BE PROPERLY SOLDERED.**

Our factory terminations are installed by GM approved termination presses, and soldering is not necessary on these terminations.

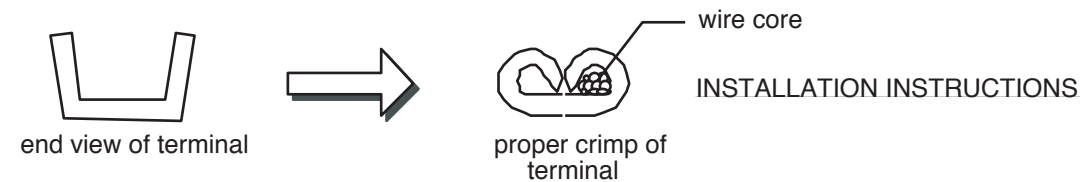

### STEP 1: DISCONNECT YOUR BATTERY:

Disconnect the battery before installing the wiring kit to prevent any accidental shorting caused by loose bare wire ends.

### STEP 2: START INSTALLING KIT:

This kit is broken down into individual steps that are identified by a letter printed on the instruction sheets visible through each bag. These letters are the order of operation for installing your kit. Start with the bag letter G, then H, etc. The order of installation is shown below.

- G 510495 Dash Harness Kit
- H 510498 Instrument Cluster Kit
- J 510496 Engine Kit
- L 510497 Front Light Kit
- M 510095 Rear Body Kit
- N 500708 Courtesy Light Kit
- V 510730 VSS Connection Kit
- Z 510476 Alternator and Main Connection Kit

### STEP 3: RECONNECT YOUR BATTERY:

When you have completed the installation and are ready to reconnect the battery, make sure that the following electrical system grounds are in place:

- A. Battery is grounded to the ENGINE BLOCK.
- B. Battery is grounded to the frame.
- C. Engine block is grounded to the frame.
- D. Body is grounded to the frame.

### STEP 4: CHECK ALL ELECTRICAL FUNCTIONS:

Any non-functioning items should be checked for proper installation. Any problems with your wiring and electrical circuit functions should be addressed to American Autowire Systems, Inc. as soon as possible to avoid any warranty problems.

If you have any questions concerning this or any of our products, please feel free to call us at 1-800-482-WIRE.

AMERICAN AUTOWIRE MAKES IT EASY !!

We carry many accessories for your 1969-72 Chevy Truck

p/n R0067108  
OEM style non-stick harness tape



p/n 38131  
Breakerless Ignition Module,  
GM V-8 POINT CONVERSION KIT



p/n 500523  
OEM large terminal and double  
crimping tool (20-8 gauge).



p/n 500649  
Multi-crimp tool (20-14 gauge).

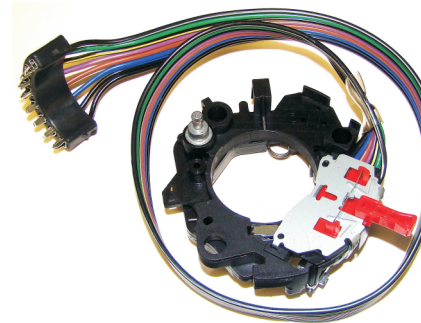

OEM steering column turn signal switch.

- p/n 01893596 (1967-72) - all, with tilt, auto. trans.
- p/n 01997961 (1967-72) - all, with tilt,  
with correct red hazard knob
- p/n 01893591 (1967-72) - all, with tilt, manual. trans.
- p/n 01997965 (1967-72) - all, without tilt,  
with correct red hazard knob.
- p/n 01894852 (1967-72) - all, without tilt,  
service replacement only

p/n 01513321 (1962-72)  
OEM Water temperature gauge -  
for factory gauge trucks

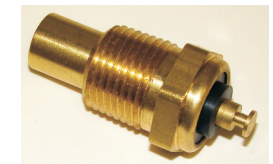

OEM style neutral safety/backup switch.

- p/n 01993320 (1960-72)  
Column shift TH auto. trans.
- p/n 01993659 (1960-72)  
Column shift PG auto. trans.



p/n 01993432 (68-72) 2 spd w/washer

OEM style wiper switch.

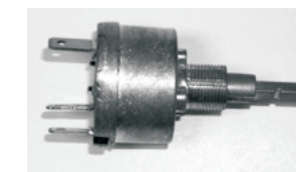

p/n 36388 (1967-72)

Factory assembly manual.  
(It's what they used on the assembly  
line to build your Truck!)



American Autowire / Factory-Fit  
800-482-9473

## Classic Update Series

1969-72 Chevy & GMC Truck

# 510089

© COPYRIGHT 2004 American Autowire / Factory-Fit  
Used with express permission of  
American Autowire / Factory-Fit  
92972498 instruction sheet rev. 0.0 8/1/2019

# Classic Update Series

## 1969-72 Chevy & GMC Truck



American Autowire / Factory-Fit  
800-482-9473

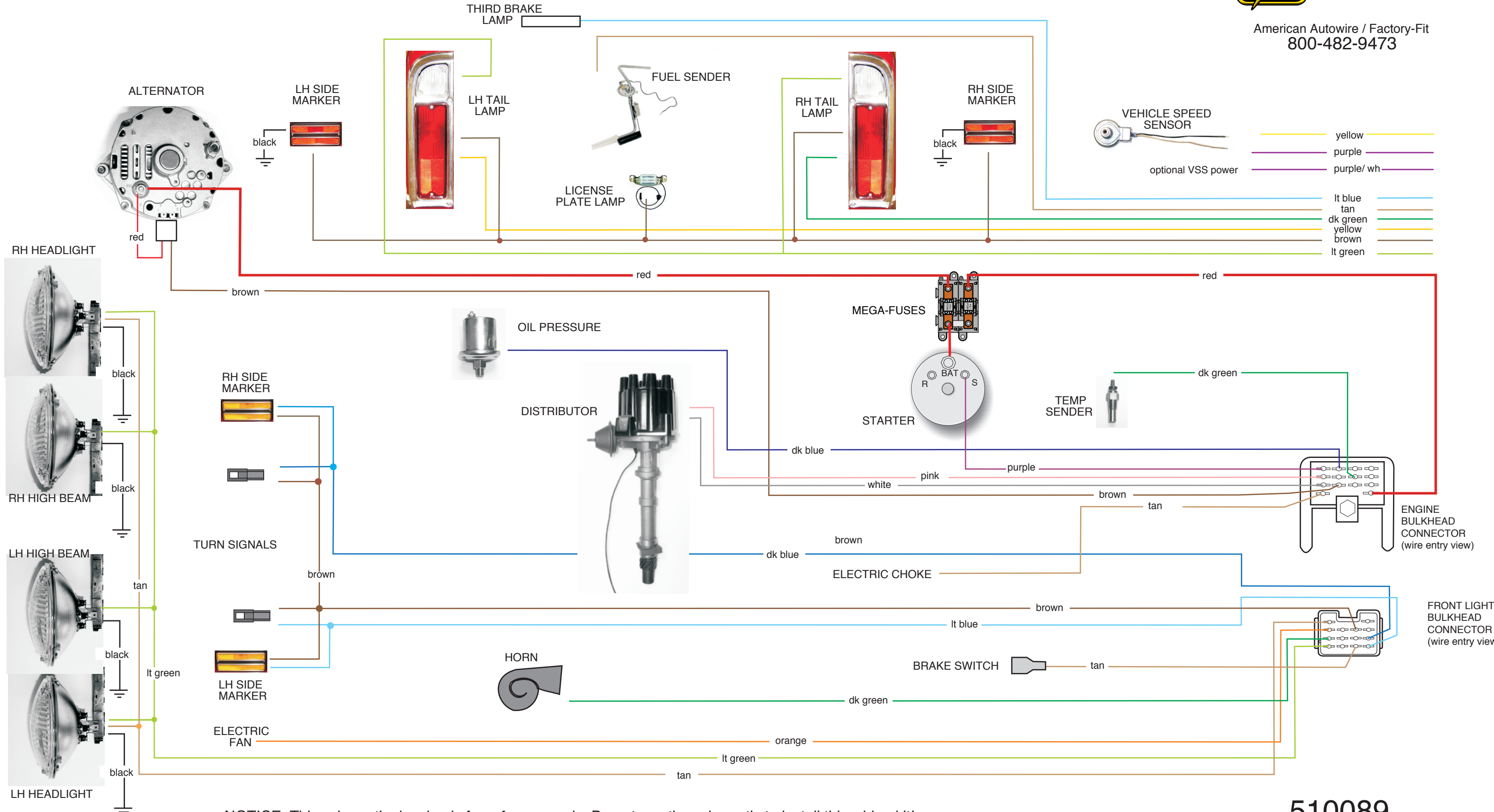

NOTICE: This schematic drawing is for reference only. Do not use the schematic to install this wiring kit! Use the instruction sheets included in each bag, which includes directions for proper terminations, and specific applications).

510089

© COPYRIGHT 2004 American Autowire / Factory-Fit  
Used with express permission of  
American Autowire / Factory-Fit  
92972498 instruction sheet rev. 0.0 8/1/2019



American Autowire / Factory-Fit  
800-482-9473

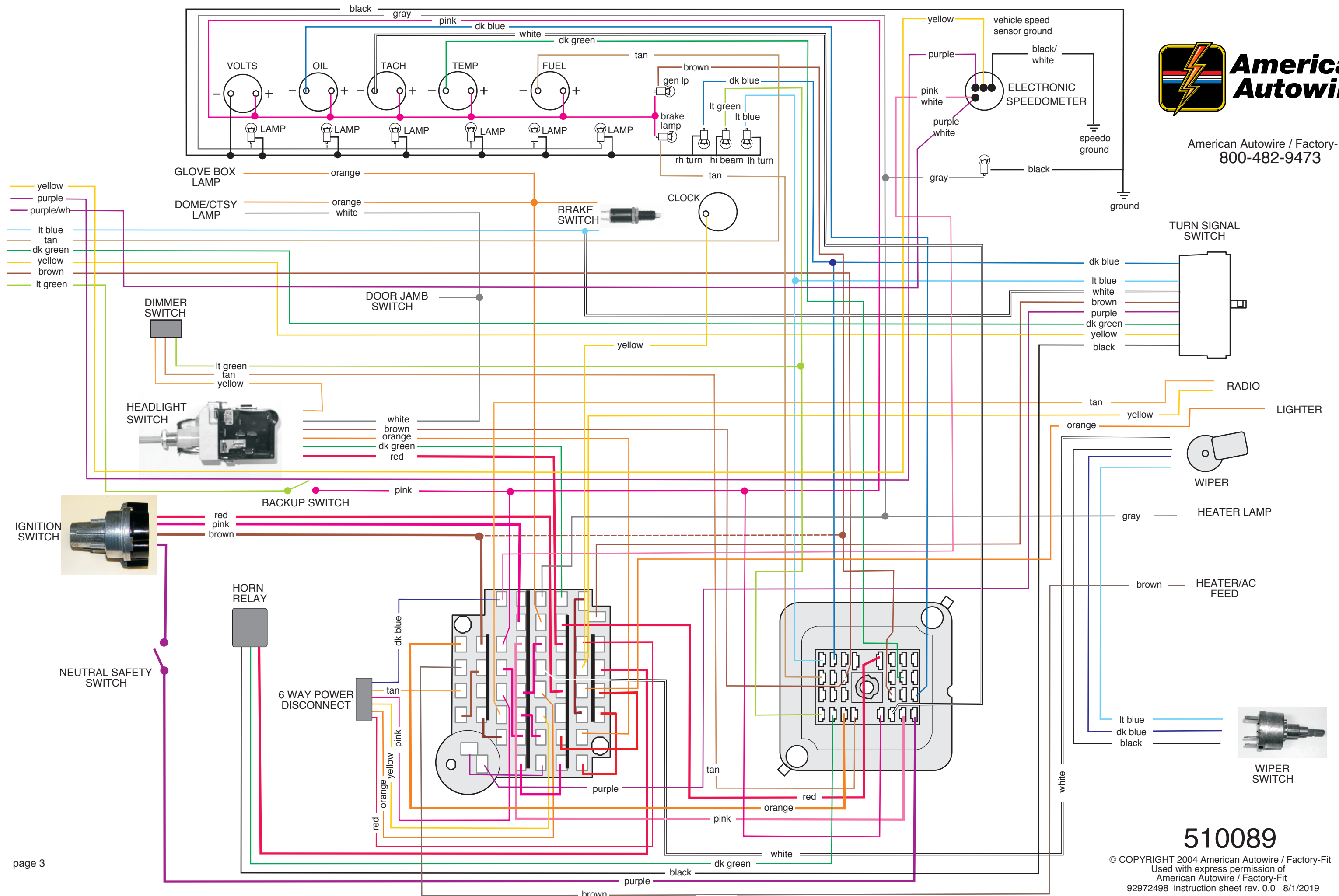

510089

THIS PAGE HAS BEEN INTENTIONALLY LEFT BLANK



## Template for firewall modification for some Classic Update Kits

Classic Update Series kits are based on the 1968 and later GM bulkhead assembly which has a different mounting footprint than earlier bulkhead connectors. Therefore, it will be necessary to modify the firewall of the 1961-1964 Chevy Fullsize cars, the 1967-1968 Chevy and GMC trucks, and the 1969-1972 Chevy and GMC trucks to accept the 1968 and later design bulkhead. This enclosed template must be used for this purpose.

The white area should be cut out with a razor knife to define the area of material that needs to be removed from the existing bulkhead area. We suggest that this template be glued to stiff cardboard or a thin piece of plastic or be applied directly to the cleaned firewall on the inside of the car then proceed as follows:

1. Position the template against the firewall aligning the top and right hand edges with the top and right hand edges of the existing bulkhead hole.
2. Trace the opening area onto the existing bulkhead and cut out the area.
3. Drill the two .125 holes for the new bulkhead mounting screws.
4. Mount the fuse box assembly from the passenger compartment side and check the fit into the new bulkhead hole. It may be necessary the do some fine tuning on the hole size for an exact fit.
5. Screw in the new fuse box retaining screws to complete securing the new fuse box assembly to the firewall

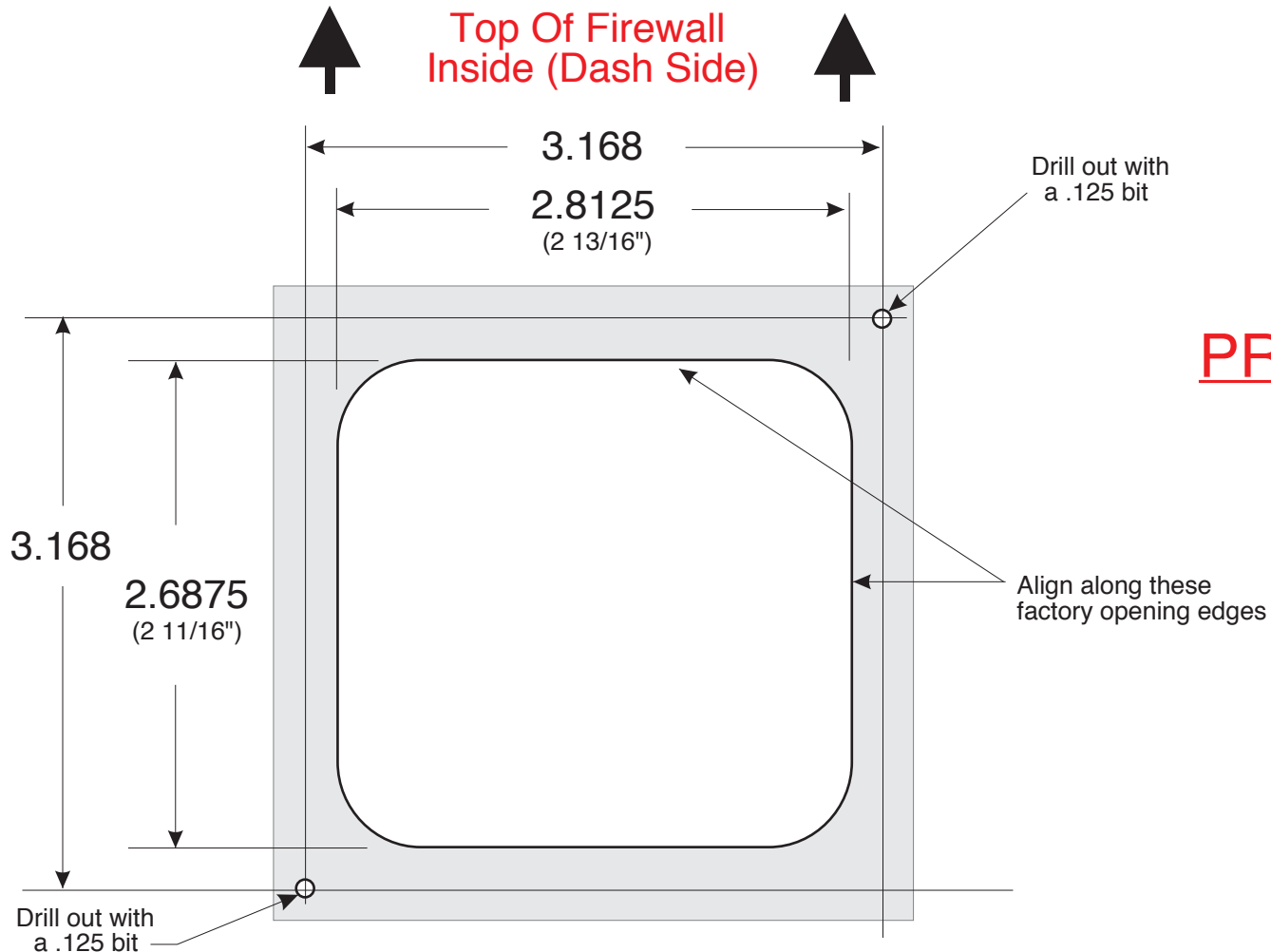

**PRINT ON ADHESIVE LABEL SHEET**

**92968980**



On the next 4 pages, you will find several detailed specialized instructions that will help you install our 1969-72 Chevy or GMC Truck Classic Update Kit, P/N 510089, into your 1967-68 Chevy or GMC Truck. These instructions along with the parts and specialized harnesses from the 510334 Jumper kit will need to be used in conjunction with the corresponding instructions and many parts, from the 510495 Dash, the 510497 Front Light, and the 510095 Rear Body kits. These various modifications include adding all or some of the following special jumper harnesses: windshield wiper switch, 1967 **only** front parking lamp, and 1967 **only** rear tail lamp extensions. The balance of the 1969-1972 Chevy and GMC Truck kit will install into any 1967-68 Chevy or GMC Truck without any further modifications.

[www.americanautowire.com](http://www.americanautowire.com) 856-933-0801

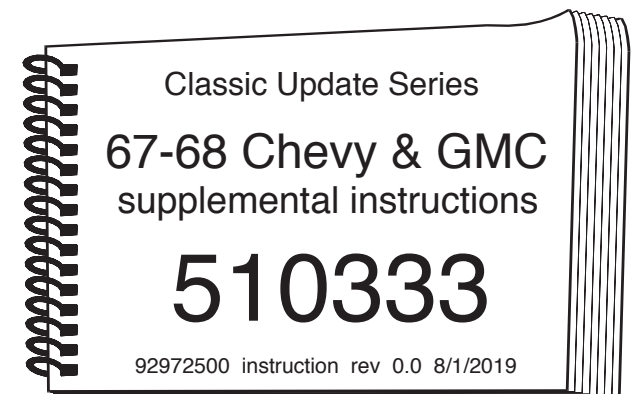

# Classic Update Series

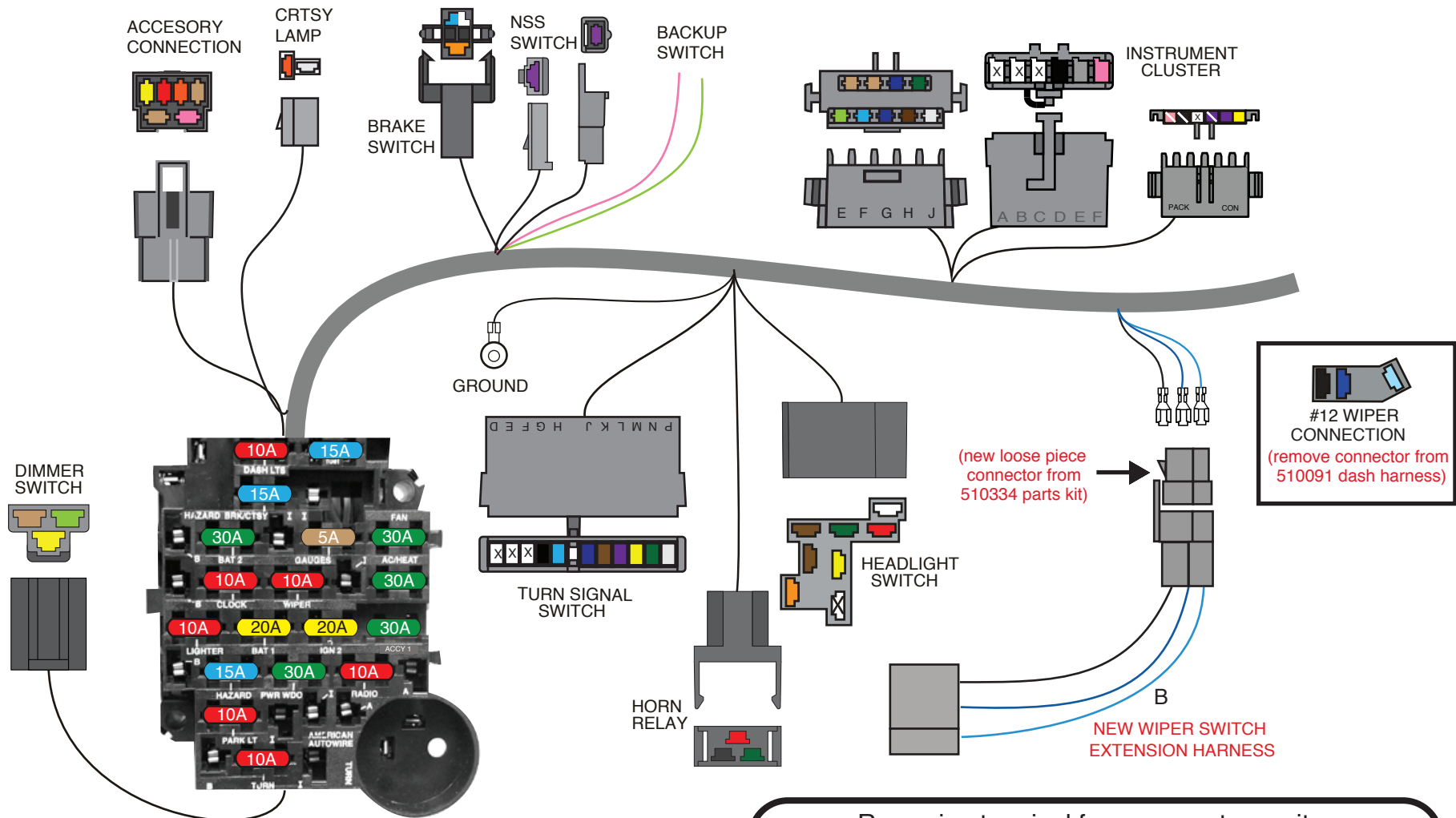

1. Remove the wiper switch connector from location number 12 on the '69-'72 dash harness, 510495 - bag G, as shown above by simply inserting a small screwdriver or thin pick into the face of the connector and releasing the locking tabs on the 3 terminals (be sure to lift those locking tabs back up once the terminals have been removed so they will lock into the new connector in step 2).

2. Install the lt. blue, dk. blue, and black wires from the wiper switch connection of the dash harness, 510495, into the new 3 position connector A from kit 510334. Be sure to maintain color continuity with the New Wiper Switch Extension Harness. If for some reason you damage the wiper terminals of the original dash harness, new ones have been provided for you in the 510334 kit. Simply cut off the old terminals and crimp the new ones on prior to plugging in the new connector.

3. Plug the New Wiper Switch Extension Harness B onto connector A from step 2 above, then plug this new connection onto your 1967-68 wiper switch to complete the wiper circuit of your 1967-68 Chevy or GMC Truck.

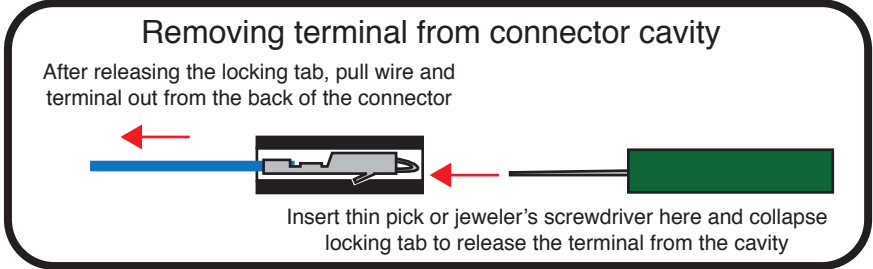

Wiper  
Switch Extension  
67-68 Chevy & GMC

**510333**

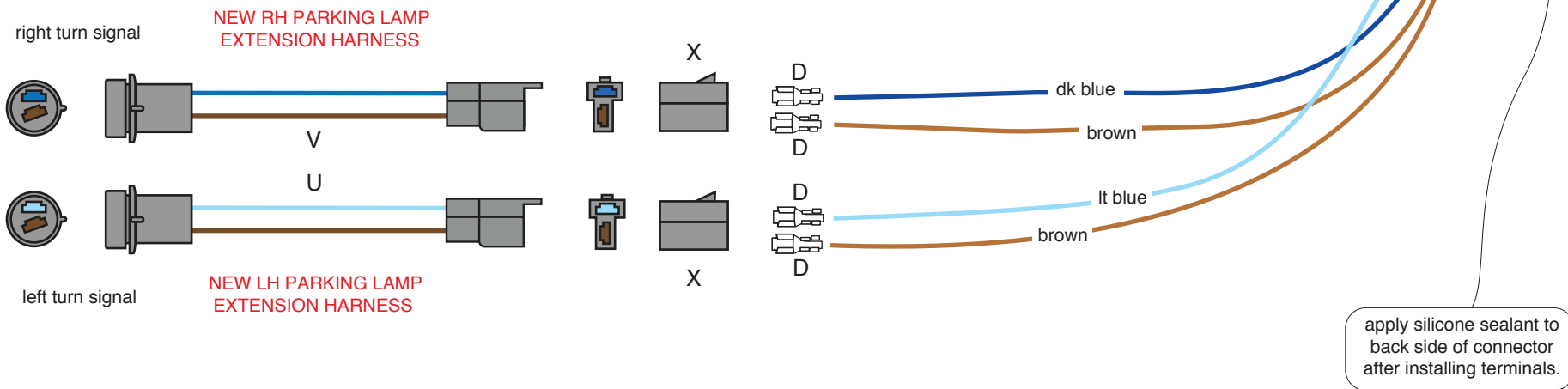

1. Original 1967 Chevy truck parking lamp mold-on connections used a unique blade configuration, and as such, you will need to use the 1967 parking lamp extensions LH U (light blue and brown), and a RH V (dark blue and brown) contained in kit 510334 to complete your front parking lamp connections. **NOTE:** If you are using reproduction 1967-68 parking lamp assemblies (which are made incorrectly using the 69-72 style ends), you will simply use the connections contained in the 510497 front lamp kit as is. It will not be necessary to use these unique parking lamp extensions.

2. Assemble the 510497 - bag L front light kit as shown on the that instruction set with the exception of the front parking lamp connections. Instead of plugging your light blue, dark blue, and brown parking/turn signal lamp wires into connectors H as shown on instruction set 510497, plug them into connectors X contained in kit 510334 as shown above maintaining color continuity with the LH and RH parking lamp extensions.

2. Plug the new LH and RH parking lamp extensions U and V onto your newly completed 510497 front light kit as shown above, then plug those extensions into your 1967 front parking lamp assemblies to complete the LH and RH parking lamp circuits of your 1967 Chevy Truck.

1967 Front Parking  
Lamp Extensions  
67-68 Chevy & GMC

# 510333

# ClassicUpdate Series

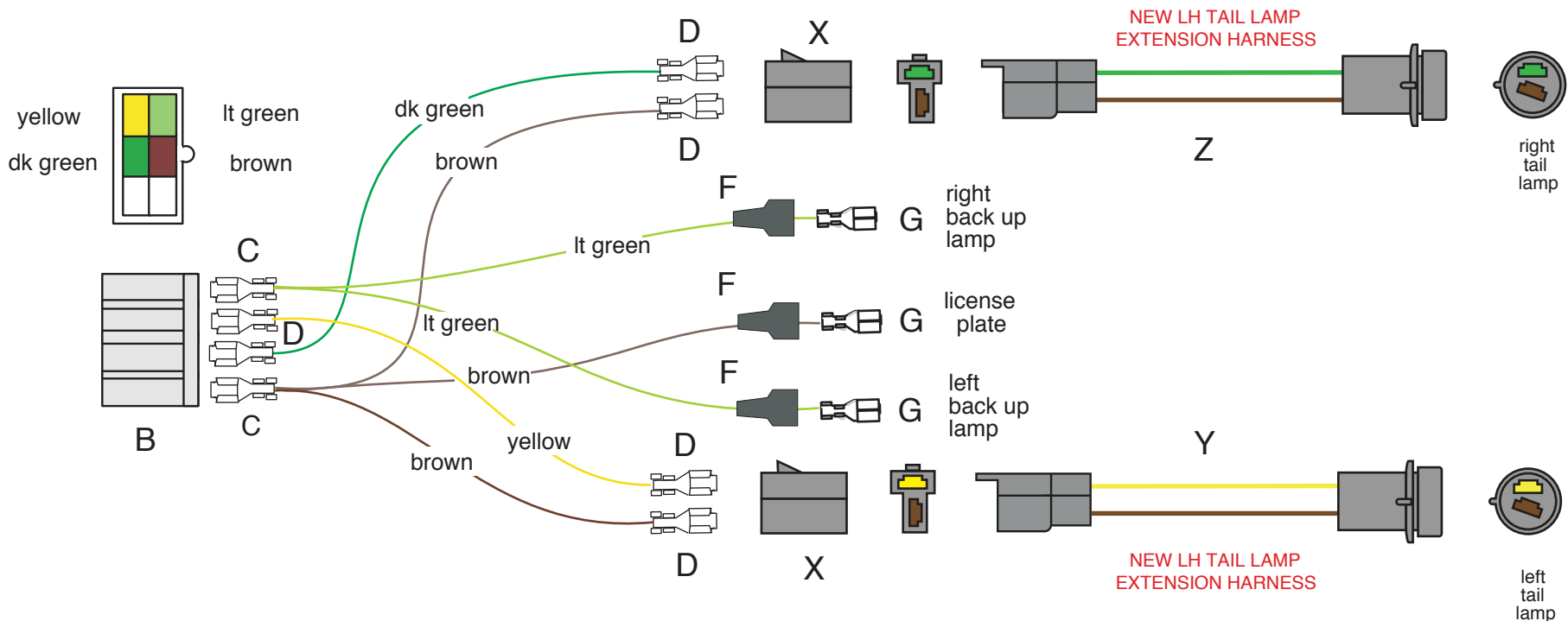

1. The 1967 Chevy STEPSIDE ONLY truck tail lamp mold-on connections used a unique blade configuration, and as such, you will need to use the 1967 tail lamp extensions LH Y (yellow and brown), and a RH Z (dark green and brown) contained in kit 510334 to complete your rear tail lamp connections.

2. Assemble the 510095 - bag M rear body kit as shown on the that instruction set with the exception of the stepside tail lamp connections shown on sheet 3 of that instruction set. Instead of plugging your yellow, dark green, and brown tail/turn signal lamp wires into connectors H as shown on instruction set 510095 sheet 3, plug them into connectors X contained in kit 510334 as shown above maintaining color continuity with the LH and RH tail lamp extensions.

2. Plug the new LH and RH tail lamp extensions Y and Z onto your newly completed 510095 rear body light kit as shown above, then plug those extensions into your rear tail lamp assemblies to complete the LH and RH tail lamp circuits of your 1967 Chevy stepside truck.

1967 Stepside  
**ONLY** Rear Tail  
 Lamp Extensions  
 67-68 Chevy & GMC

# 510333

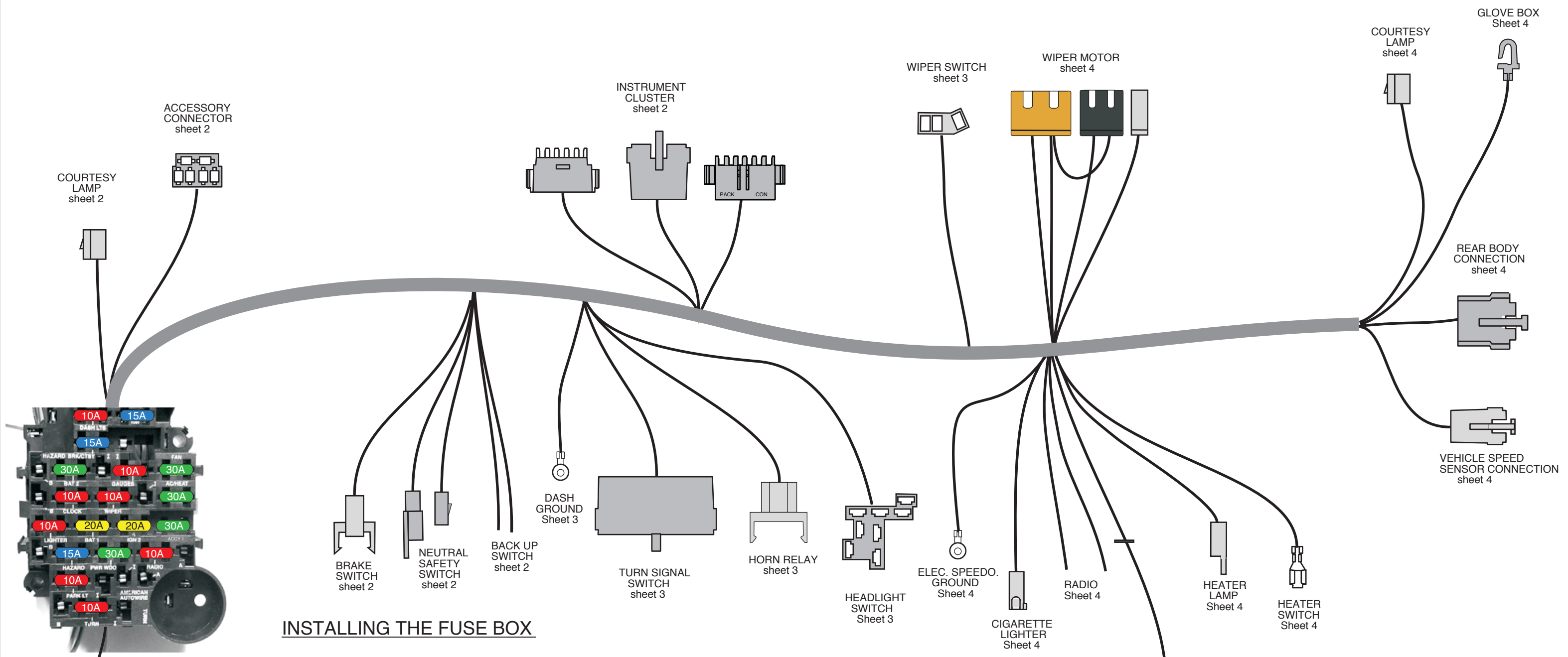

**INSTALLING THE FUSE BOX**

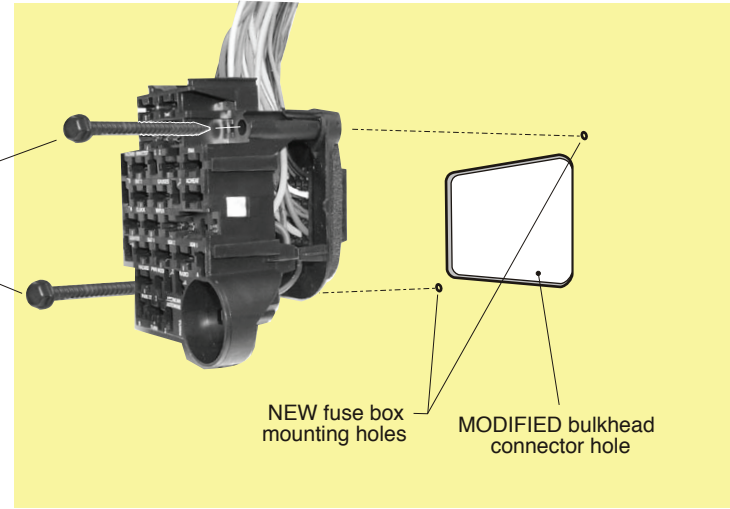

1. Locate the stock OEM bulkhead hole in the driver side of the firewall. **NOTE: You will need to modify the opening in the firewall by making it larger. See firewall template 92968980 to help with this operation.**
2. Mount the fuse box with the flasher can in the bottom right corner, as shown above.
3. Using the two mounting screws A, attach the fuse panel to the firewall.

**Fuse Panel Installation Instructions**

Following these simple instructions will guarantee a successful installation of your American Autowire fuse panel harness.

1. Study the diagram above to familiarize yourself with the dash harness.
2. Modify your firewall opening and install the fuse box (see item #1 below left, and 92968980 template).
3. Route the dash harness using the factory support straps.
4. Make all connections as shown on the following pages of this dash harness kit.
5. Once this harness is installed, continue to bag 'H', and install the rest of the kit (bags H,J,K,L,M).



www.americanautowire.com 856-933-0801

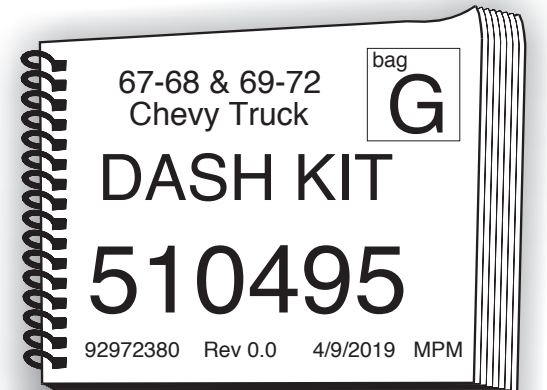

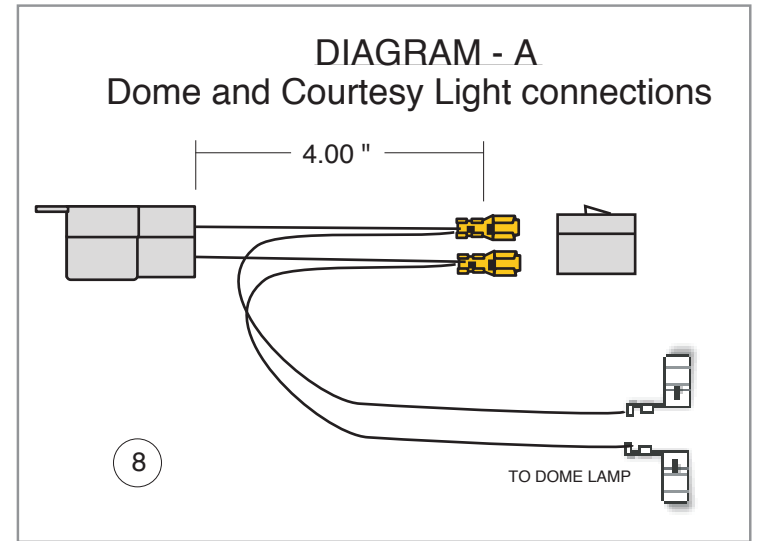
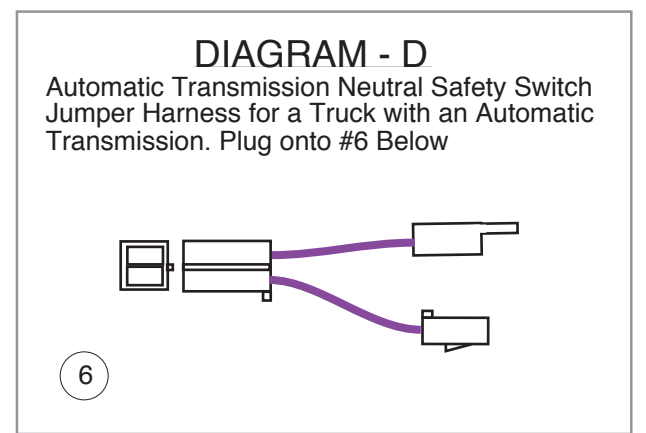
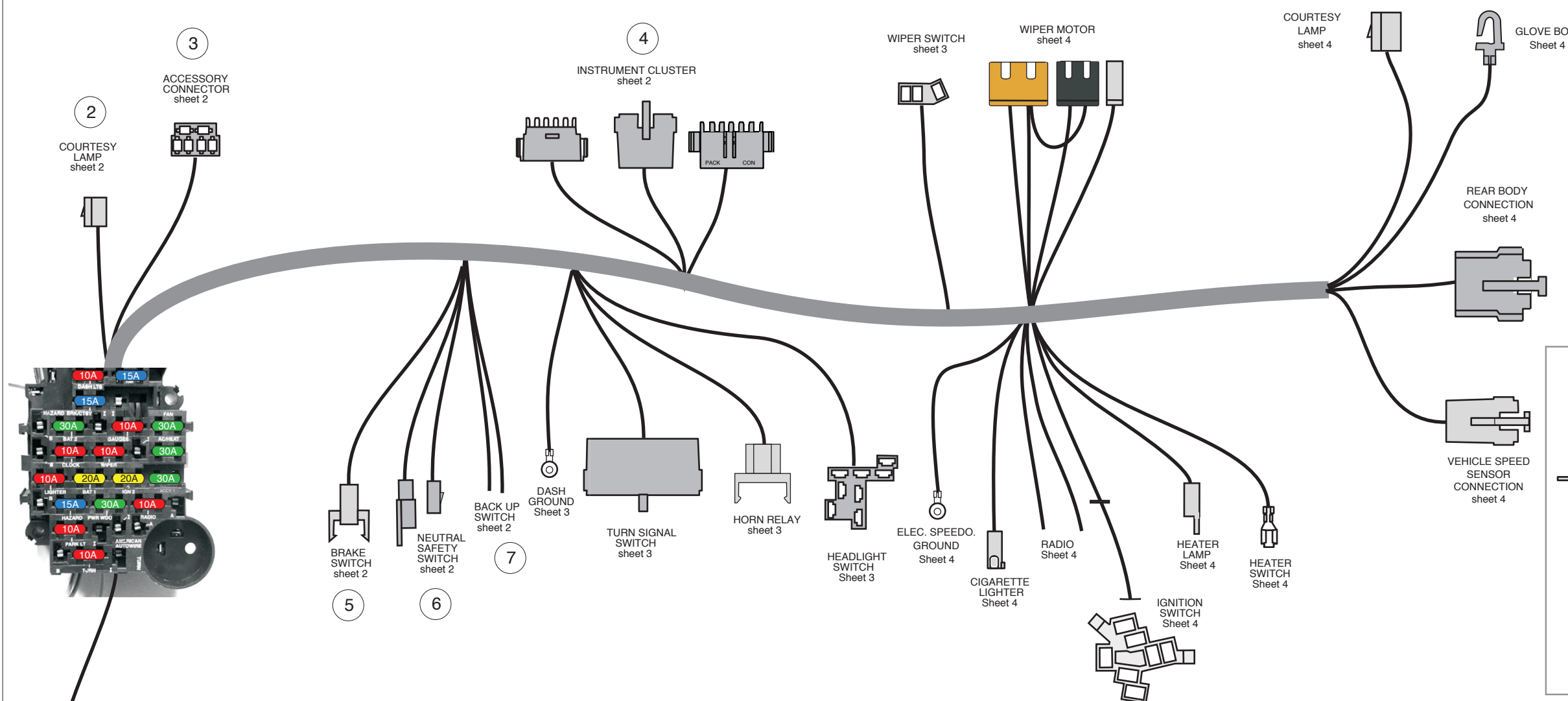

1. **FLOOR DIMMER SWITCH** Plug this connector into the floor dimmer switch (part # 510104).  
 Yellow Dimmer feed to DIMMER FEED location on headlight switch.  
 Light Green Headlight High Beam Feed 'HEADLIGHT - HIGH BEAM' from dimmer switch through the bulkhead connector to the front headlight connector high beam location.  
 Tan Headlight High Low Feed 'HEADLIGHT - LOW BEAM' from dimmer switch through the bulkhead connector to the front headlight connector low beam location.
2. **LH COURTESY LAMP** Plug this connector into the mating connector from the courtesy lamp kit bag N, 500708.  
 Orange 12 volt battery feed for lamp  
 White Ground circuit for lamp
3. **ACCESSORIES** Use the provided connector J attached and terminals as power leads for the following:
 

	Fuse	Rating	
Dark Blue	FUEL	15 amp	Fused 12 volt IGNITION feed for fuel pump (may also be used to feed power to another ignition circuit)
Orange	BAT1	20 amp	Fused 12 volt BATTERY feed for power seats (may also be used to feed power to another battery circuit)
Red	BAT2	30 amp	Fused 12 volt BATTERY feed for power door locks (may also be used to feed power to another accessory circuit)
Pink	IGN1	20 amp	Fused 12 volt IGNITION feed for cruise control (may also be used to feed power to another ignition circuit)
Yellow	PWRWDO	30 amp	Fused 12 volt IGNITION feed for power windows (may also be used to feed power to another ignition circuit)
Tan	ACCY1	30 amp	Fused 12 volt ACCESSORY feed (may also be used to feed power to an accessory circuit)
4. **INSTRUMENT CLUSTER DISCONNECTS** These connectors will plug into the gauge disconnect harness from bag H. Wire identifications are described on the instruction sheets from bag H.
5. **BRAKE SWITCH** Plug this connector into the factory brake switch.  
 Orange 12 volt feed 'in' to switch.  
 White 12 volt feed 'out' to steering column switch.  
 Lt Blue 12 volt feed 'out' to third brake light.
6. **NEUTRAL SAFETY SWITCH** If using an automatic transmission, plug these wires into the NSS jumper harness in Diagram D, then plug onto the neutral safety switch on the column, or plug together if using a manual transmission.  
 Purple 12 volt feed 'in' to neutral safety switch.  
 Purple 12 volt feed 'out' to starter
7. **BACK UP SWITCH** Connect these wires to the back up switch on the column, console shifter, or transmission.  
 Pink 12 volt ignition feed 'in' to back up lamp switch  
 Lt Green 12 volt feed 'out' to back up lamps
8. **DOME LAMP**
  - a. If no under dash courtesy lamps are desired, plug dome lamp harness in at location #2, and route the other end to the dome lamp assembly.
  - b. If under dash courtesy lamps are desired, cut the enclosed dome lamp harness 4" from the main connector, double with the cutoff portion using the enclosed terminals, and plug into the provided connector as shown in Diagram "A". Install the completed dome lamp harness onto dash harness onto dash harness at location #2, then plug in the under dash courtesy lamp from bag N, 500708 to the pigtail on this dome lamp connection. (see Diagram "A" for this application)
 Orange 12 volt battery feed for lamp  
 White Ground circuit for lamp



www.americanautowire.com 856-933-0801

bag  
**G**

67-68 & 69-72  
Chevy Truck

## DASH KIT

# 510495

92972380 Rev 0.0 4/9/2019 MPM

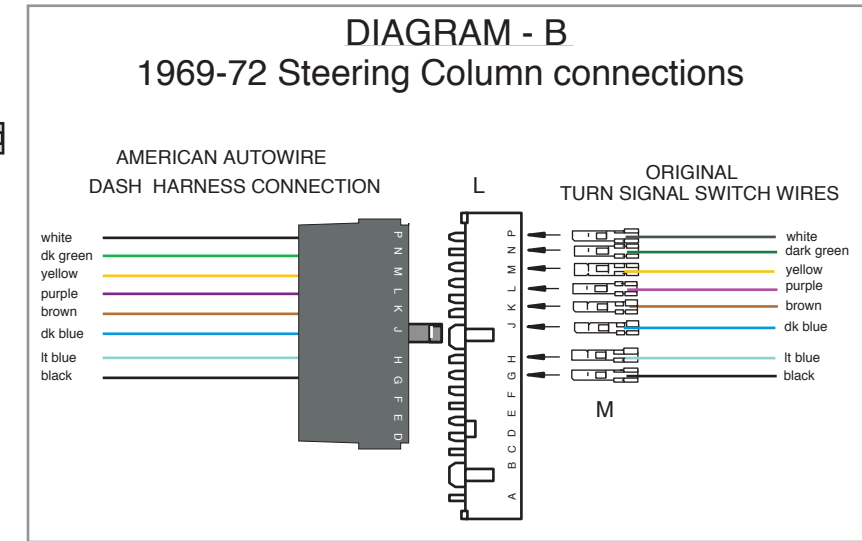
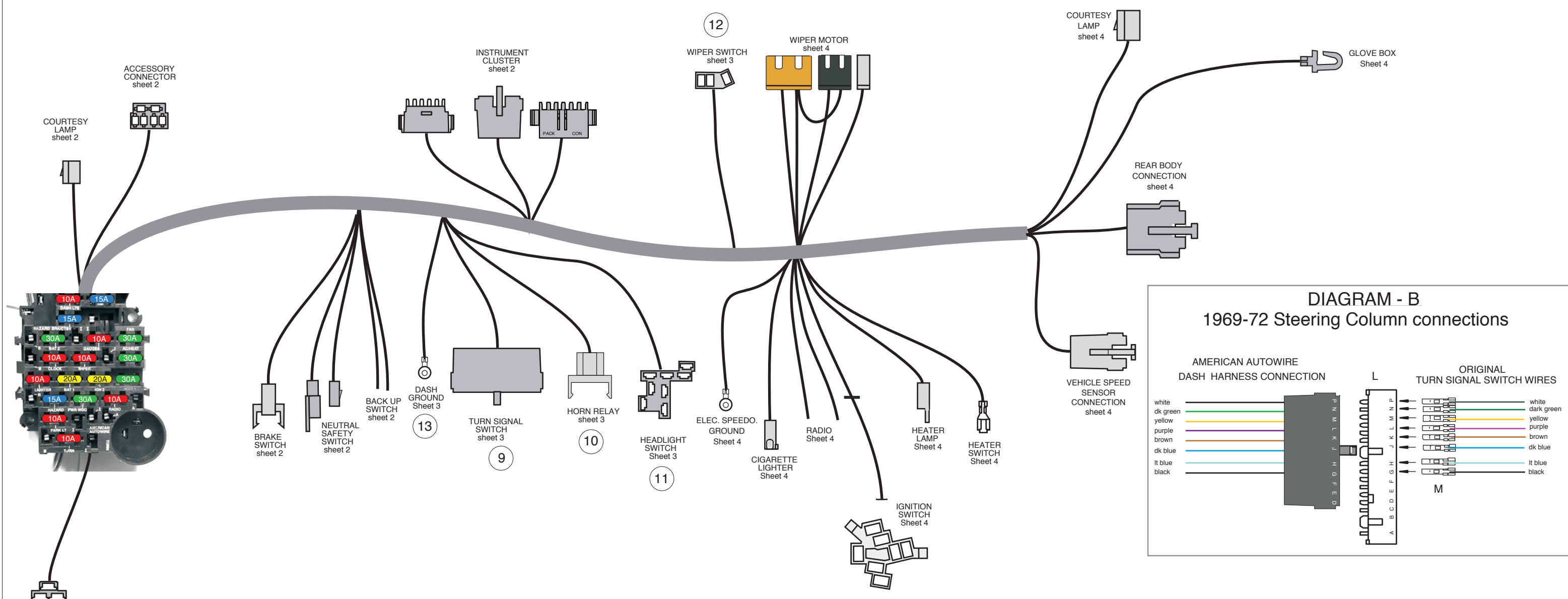

- |  |  |  |
|--|--|--|
| <p>9. TURN SIGNAL SWITCH</p> <p>10. HORN RELAY</p> <p>11. HEADLIGHT SWITCH</p> <p>12. WIPER SWITCH</p> <p>13. GROUND</p> | <p>This harness is set up for a 1969-74 GM or Steering column utilizing a 3 7/8 turn signal switch connector. If you are using your truck's original column, we have included the proper connector (L) and terminals (M) for you to cut off your existing connector and adapt it into our new dash harness. If using a 1975 or later GM steering column or an after-market steering column using a GM turn signal switch with the 4-1/4 GM turn signal connector, it will be necessary to replace the 4 1/4 turn signal switch connector with the included 3 7/8 connector L, matching wires by color. (see Diagram "B" for this application)</p> <p>White 12 volt feed from brake switch<br/>Dark Green RH tail lamp<br/>Yellow LH tail lamp<br/>Purple 12 volt feed from turn flasher<br/>Brown 12 volt feed from hazard flasher<br/>Dark Blue RH front park lamp<br/>Light Blue LH front park lamp<br/>Black Horn relay ground wire to horn switch</p> <p>Plug the horn relay (found in the fuse bag) into this connector.<br/>Red 12 volt battery<br/>Black Relay ground circuit (to steering column)<br/>Green Triggered 12 volts to horn</p> <p>Red 12 volt feed to switch<br/>Orange 12 volt feed in to park/tail<br/>Brown Park lamp feed out<br/>Yellow Dimmer feed<br/>Dk Green Instrument lamp feed<br/>White Dome / courtesy ground</p> <p>Plug this connector into the stock wiper switch.<br/>Black Low speed ground<br/>Light Blue High speed ground<br/>Dark Blue Washer pump ground</p> <p>Black Connect to a good chassis ground</p> | <p>'BAT' location on headlight switch<br/>PARK / TAIL FEED IN location on headlight switch. (commonly found on GM headlight switches)<br/>PARK LAMP OUT location on headlight switch.<br/>DIMMER FEED location on headlight switch.<br/>INSTRUMENT LAMP location on headlight switch.<br/>GROUND location on headlight switch.</p> |
|--|--|--|



www.americanautowire.com 856-933-0801

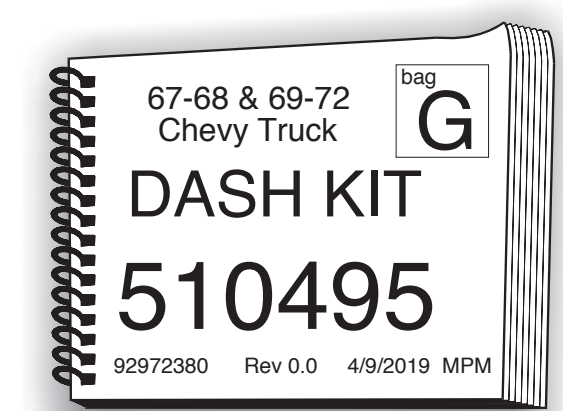

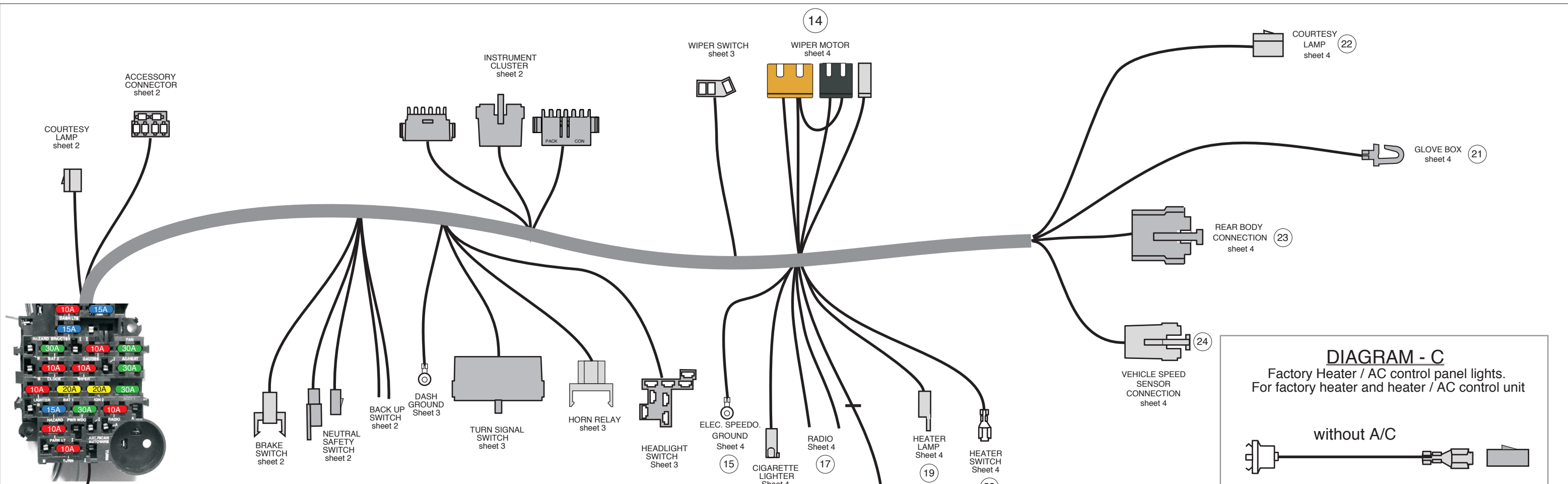

- |     |                      |  |
|-----|----------------------|--|
| 14. | WIPER MOTOR          | Plug these connectors into the stock wiper motor. The connectors are indexed and can only be plugged in one way.<br>White 12 volt ignition<br>Black Low Speed Ground<br>Light Blue High Speed Ground<br>Dark Blue Washer Pump Ground   |
| 15. | ELECT. SPEEDO GROUND | Black/White Connect to a good chassis ground. DO NOT attach under the same screw as any other ground wire.   |
| 16. | CIGARETTE LIGHTER    | Orange Connect to lighter. (battery feed)  |
| 17. | RADIO                | Tan Radio accessory feed. (On-Off switch)<br>Yellow Radio 12 volt clock lead (battery feed)  |
| 18. | IGNITION SWITCH      | Red 12 volt battery feed<br>Pink 12 volt ignition feed<br>Brown 12 volt accessory feed<br>Purple 12 volt starter feed  |
| 19. | HEATER LAMP          | AAW has provided 2 dash lamp pigtail wires for final connection to you heater or A/C control unit. If your truck has a heater only, use the single wire terminal (silver), install onto 1 pigtail, plug into the provided connector, and install onto the dash harness at location #18. If your truck has factory air, use the double wire terminal (brass), double onto both pigtail wires, plug into the provided connector, and install onto the dash harness at location #19.<br><br>Gray Heater lamp (see Diagram "C" for your application)   |
| 20. | HEATER SWITCH        | AAW has provided the heater or A/C feed wire only for this application to be used in conjunction with your OE factory heater or A/C harness. If you desire a new heater or A/C harness for your truck, contact AAW for the exact application for your truck. (The orange A/C high speed blower power feed from your OE A/C harness can be plugged into the accessory plug #3 shown on sheet 2 by removing the black connector from the wire and installing the bare terminal into the mating cavity of the RED wire at that accessory plug.)<br><br>Brown 12 volt accessory feed to heater / ac switch. (if using aftermarket a/c, use this brown wire as the keyed accessory feed wire to a/c harness.) |
| 21. | GLOVE BOX LIGHT      | Orange Connect to the original factory glove box lamp switch. If not using, just insulate the bare terminal and tape back.   |
| 22. | RH COURTESY LAMP     | Plug this connector into the mating connector from the courtesy lamp kit bag N, 500708.<br>Orange 12 volt battery feed for lamp<br>White Ground circuit for lamp   |
| 23. | REAR BODY            | This connector will mate to the connector from the Rear Body harness found in bag M.<br>Tan Fuel tank sender lead<br>Brown Tail lamp feed<br>Yellow LH turn / brake feed<br>Dark Green RH turn / brake feed<br>Light Green Backup lamp feed<br>Light Blue Third brake light  |
| 24. | VEHICLE SPEED SENSOR | This connector will mate to the VSS Lead Wires (510370) in bag V.<br>Yellow Vehicle speed sensor ground<br>Purple Vehicle speed sensor signal<br>Purple / white Vehicle speed sensor power   |

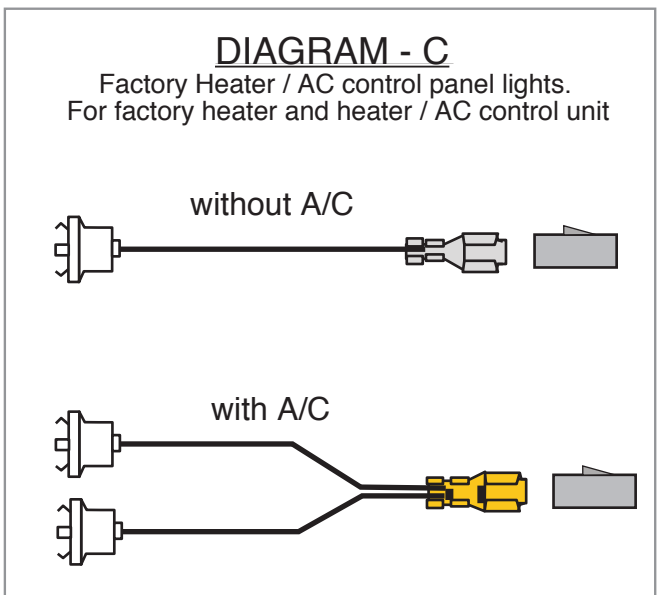

www.americanautowire.com 856-933-0801

67-68 & 69-72  
Chevy Truck **G**

**DASH KIT**

**510495**

92972380 Rev 0.0 4/1/2019 MPM



REFER TO SHEET 2 FOR CONNECTING TO A STOCK INSTRUMENT CLUSTER. IF USING A FACTORY DASH WITH A PRINTED CIRCUIT BOARD, BE SURE TO INSTALL THE WIRES AS SHOWN FOR WITH WARNING LAMPS OR WITH GAUGES.

<u>CONNECTOR F</u>		
DARK BLUE	Right Dash Ind	Route this wire to the circuit board, cut to length, install terminal C, and plug into connector D in the location shown on sheet 2.
LIGHT BLUE	Left Dash Ind	Route this wire to the circuit board, cut to length, install terminal C, and plug into connector D in the location shown on sheet 2.
LIGHT GREEN	Hi Beam Indicator	Route this wire to the circuit board, cut to length, install terminal C, and plug into connector D in the location shown on sheet 2.
DARK GREEN	Water Temp Sender	Route this wire to the circuit board, cut to length, install terminal C, and plug into connector D in the location shown on sheet 2.
DARK BLUE	Oil Pressure Sender	Route this wire to the circuit board, cut to length, install terminal C, and plug into connector D in the location shown on sheet 2.
TAN	Gas Gauge	Route this wire to the circuit board, cut to length, install terminal C, and plug into connector D in the location shown on sheet 2.
TAN	Brake Light Switch	Route this wire to the circuit board, cut to length, install terminal C, and plug into connector D in the location shown on sheet 2.

<u>CONNECTOR G</u>		
PINK	12v Ignition	Route this wire to the circuit board, cut to length, install terminal C, and plug into connector D in the location shown on sheet 2. (This application is used with a stock instrument cluster and NO TACH only!) If using a factory tach, route to tach, cut to length, double with cutoff portion, install terminal B, and plug into connector E as shown on sheet 2. Route the other end to the circuit board, cut to length, install terminal C, and plug into connector D as shown on sheet 2.
GREY	Dash Lights	Route this wire to the circuit board, cut to length, install terminal C, and plug into connector D in the location shown on sheet 2.
BLACK	Ground	Route this wire to the circuit board and cut to length, install terminal C, and plug into connector D in the location shown on sheet 2.

<u>CONNECTOR H</u>		
PURPLE	VSS Signal	This wire will plug into the dash harness connection in bag G. Connect the other end to the speedometer 'sender' terminal following the manufacturer's instructions.
YELLOW	VSS Ground	This wire will plug into the dash harness connection in bag G. Connect the other end to the ground terminal "-" on the speedometer following the manufacturer's instructions.
PURPLE/WHITE	VSS Power	This wire will plug into the dash harness connection in bag G. Connect the other end to the speedometer 'power' terminal following the manufacturer's instructions.
PINK	Speedo Power	This wire will plug into the dash harness connection in bag G. Connect the other end to the speedometer 'power' terminal following the manufacturer's instructions.
BLACK/WHITE	Speedo Ground	This wire will plug into the dash harness connection in bag G. Connect the other end to a good cluster ground following the manufacturer's instructions.

<u>LOOSE WIRES</u>		
WHITE	Coil --> Tach	This wire is used with a tachometer only. If using a tachometer, plug this wire into connector F, maintaining color continuity with the white "TACH" wire on the mating dash connector. Route this wire to the tach, cut to length, install terminal A, and plug into connector E in the location shown on sheet 2.
BROWN	Alternator Ign	Route this wire to the circuit board, cut to length, install terminal C, and plug into connector F in the location shown on sheet 2. (This wire is used with a stock warning lamp instrument cluster only!)

Terminals used in this installation.

This kit contains loose piece terminals and connectors necessary to complete a connection to a specific component. Each connection on the instruction sheet identifies specific parts by a letter code that corresponds to the letter code on a part picture identified below. The parts below are shown in actual size to help in identification. This kit will only contain those parts required for the connections in the specific sub-kit you are working on. Just match the part to the picture below to identify the part letter code you will see on the instruction sheet for the sub-kit harness you are working on. We have supplied additional terminals in the event that extra terminals are necessary.

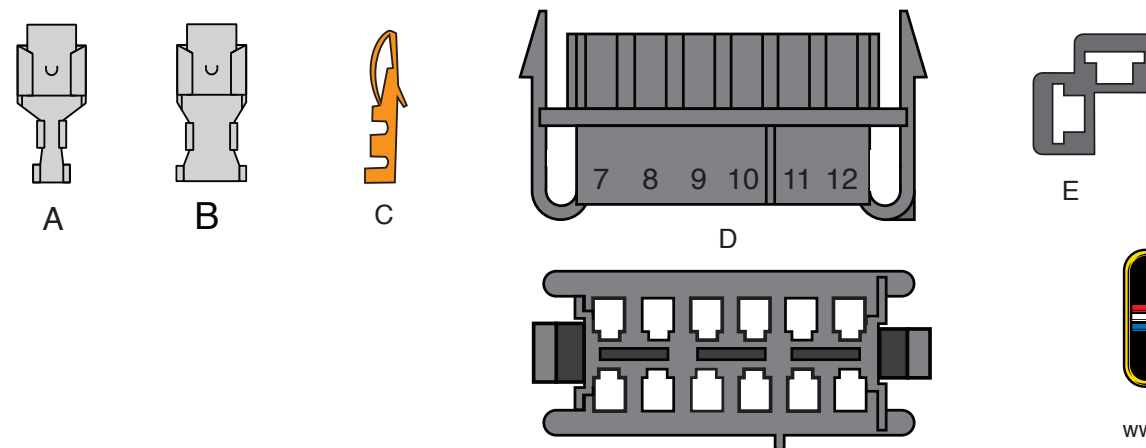

www.americanautowire.com 856-933-0801

Classic Update Series bag H  
 1967-72 Chevy  
 and GMC Truck

**INSTRUMENT  
 CLUSTER KIT  
 510498**

92972386 instruction rev 0.0 4/9/2019

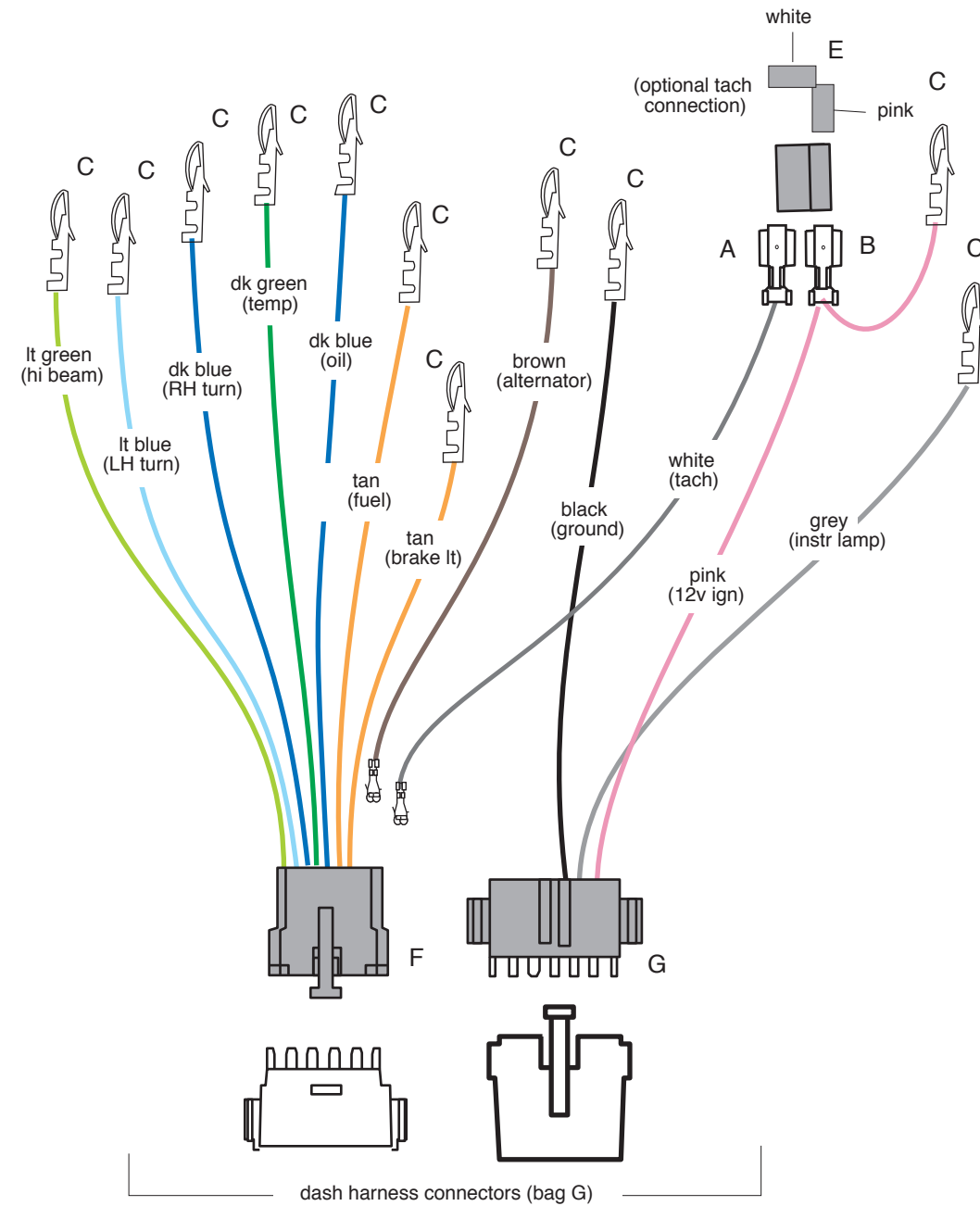

USE THIS SHEET TO CONNECT TO ANY ORIGINAL 1969-72 TRUCK FACTORY INSTRUMENT CLUSTER WITH A CIRCUIT BOARD CONNECTION

### CIRCUIT BOARD CONNECTOR WITH WARNING LIGHTS

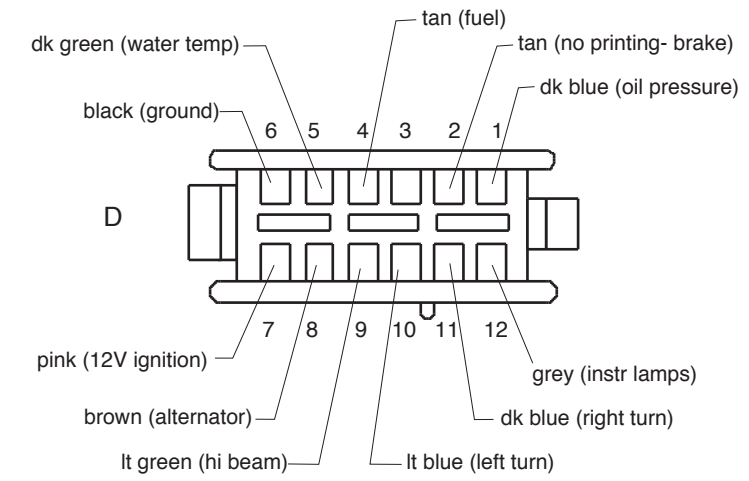

### CIRCUIT BOARD CONNECTOR WITH GAUGES

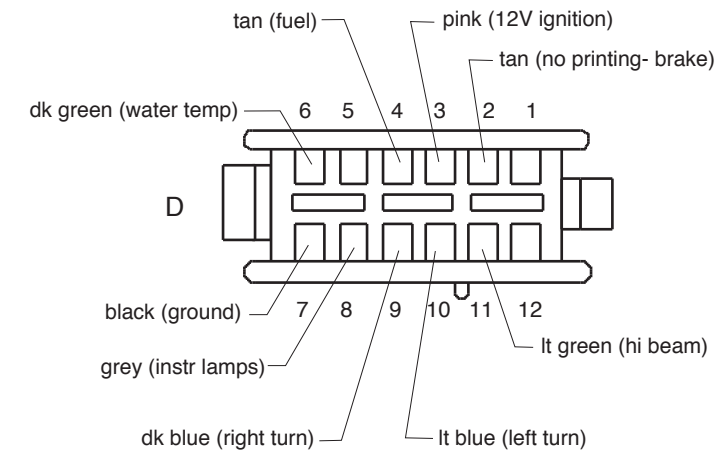

# Gauge Cluster harness (aftermarket gauges) installation instructions:

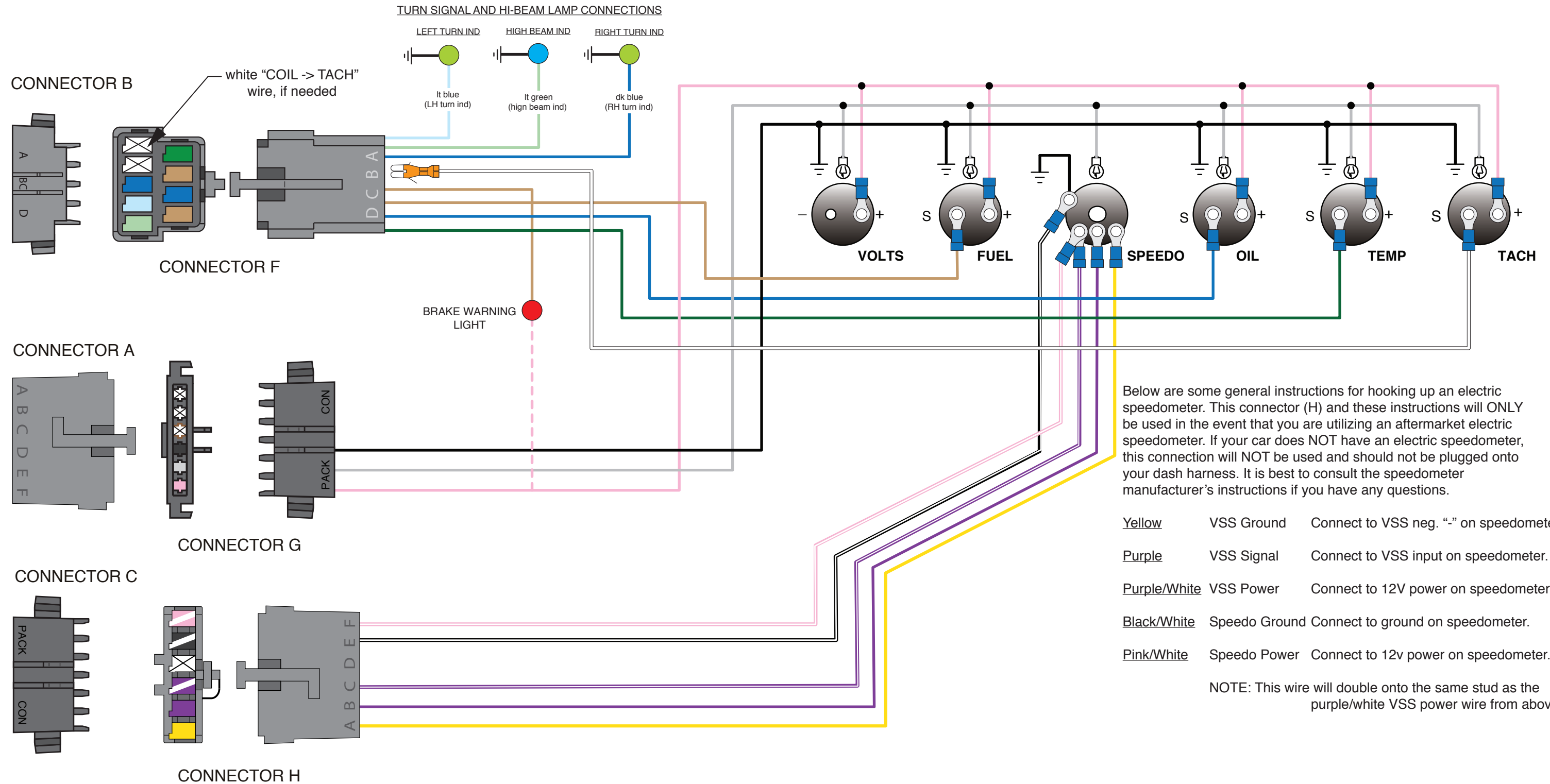

Below are some general instructions for hooking up an electric speedometer. This connector (H) and these instructions will ONLY be used in the event that you are utilizing an aftermarket electric speedometer. If your car does NOT have an electric speedometer, this connection will NOT be used and should not be plugged onto your dash harness. It is best to consult the speedometer manufacturer's instructions if you have any questions.

- Yellow** VSS Ground Connect to VSS neg. "-" on speedometer.
- Purple** VSS Signal Connect to VSS input on speedometer.
- Purple/White** VSS Power Connect to 12V power on speedometer.
- Black/White** Speedo Ground Connect to ground on speedometer.
- Pink/White** Speedo Power Connect to 12v power on speedometer.

NOTE: This wire will double onto the same stud as the purple/white VSS power wire from above.



www.americanautowire.com 856-933-0801

**INSTRUMENT CLUSTER KIT**  
 1967-72 Chevy  
 and GMC Truck  
**510498**  
 92972386 instruction rev 0.0 4/9/2019

## Electric Speedo VSS extension connection:

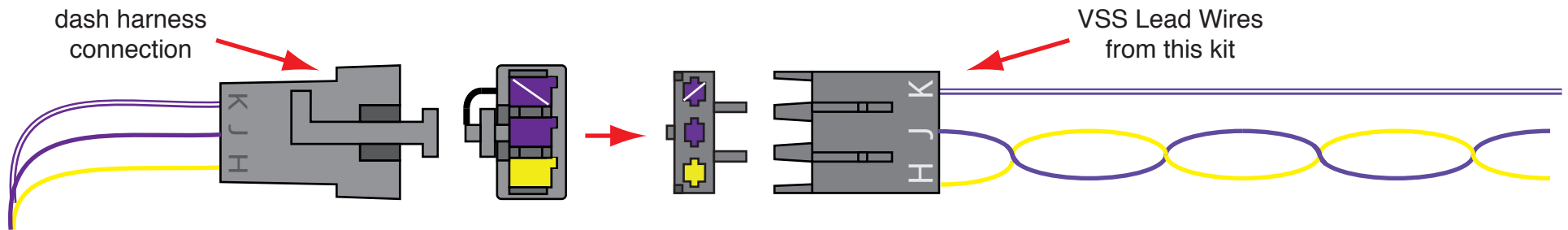

If you are using an aftermarket electric speedometer in your vehicle, you will need to connect the vehicle speed sensor (VSS) Lead Wires from this kit to the dash side connection of your dash harness. The yellow and solid purple wires must remain twisted together as shown above. These three wires will need to pass through the firewall or floor of your vehicle down to the vehicle speed sensor unit in the transmission. Generally, the solid purple wire connects to the “signal” lead, the yellow wire connects to the “ground” lead, and the purple/white stripe wire connects to the “12 volt power” lead on the vehicle speed sensor assembly. However, you should consult the directions that came with your gauges, and connect your vehicle speed sensor per the manufacturer’s instructions.



www.americanautowire.com 856-933-0801

VSS LEAD WIRES  
Various Applications  
Classic Update Series

**510730**

92972371 Rev 0.0 4/9/2019

bag  
**V**

This page intentionally left blank



# Classic Update Series

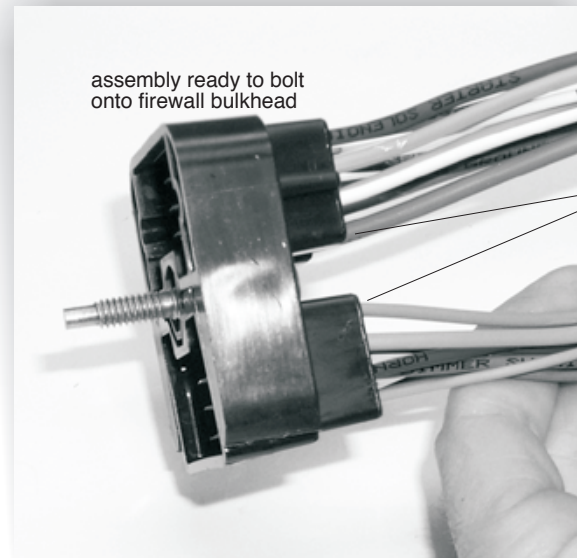
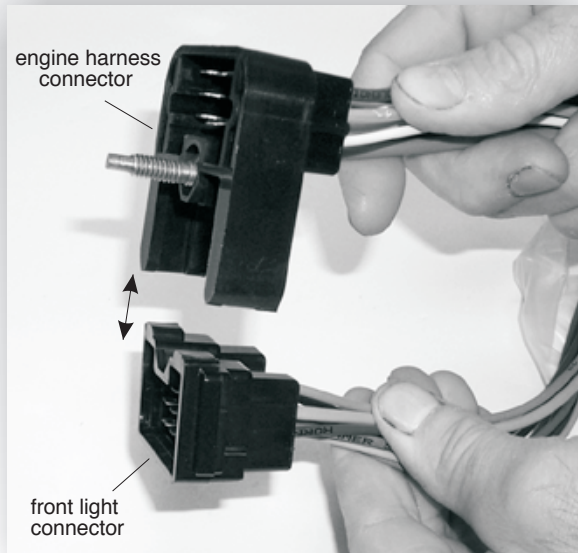

The bulkhead connector from this ENGINE KIT must snap into the mating FRONT LIGHT KIT connector (bag L), as shown. After snapping together, bolt the assembly into the dash harness firewall connector using the attached bolt.

Look!



American Autowire also sells factory OEM style harness wrap. this is the same stuff used on original Camaro harnesses! If you want that OEM look with your Classic Update wiring system, then give us a call and order p/n R0067108 !



## American Autowire

American Autowire  
800-482-9473

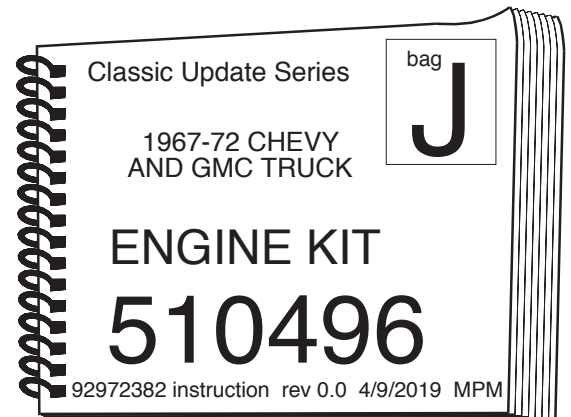

# Classic Update Series

## Terminals used in this installation.

This kit contains loose piece terminals and connectors necessary to complete a connection to a specific component. Each connection on the instruction sheet identifies specific parts by a letter code that corresponds to the letter code on a part picture identified below. The parts below are shown in actual size to help in identification. This kit will only contain those parts required for the connections in the specific sub-kit you are working on. Just match the part to the picture below to identify the part letter code you will see on the instruction sheet for the sub-kit harness you are working on. We have supplied additional terminals in the event that extra terminals are necessary.

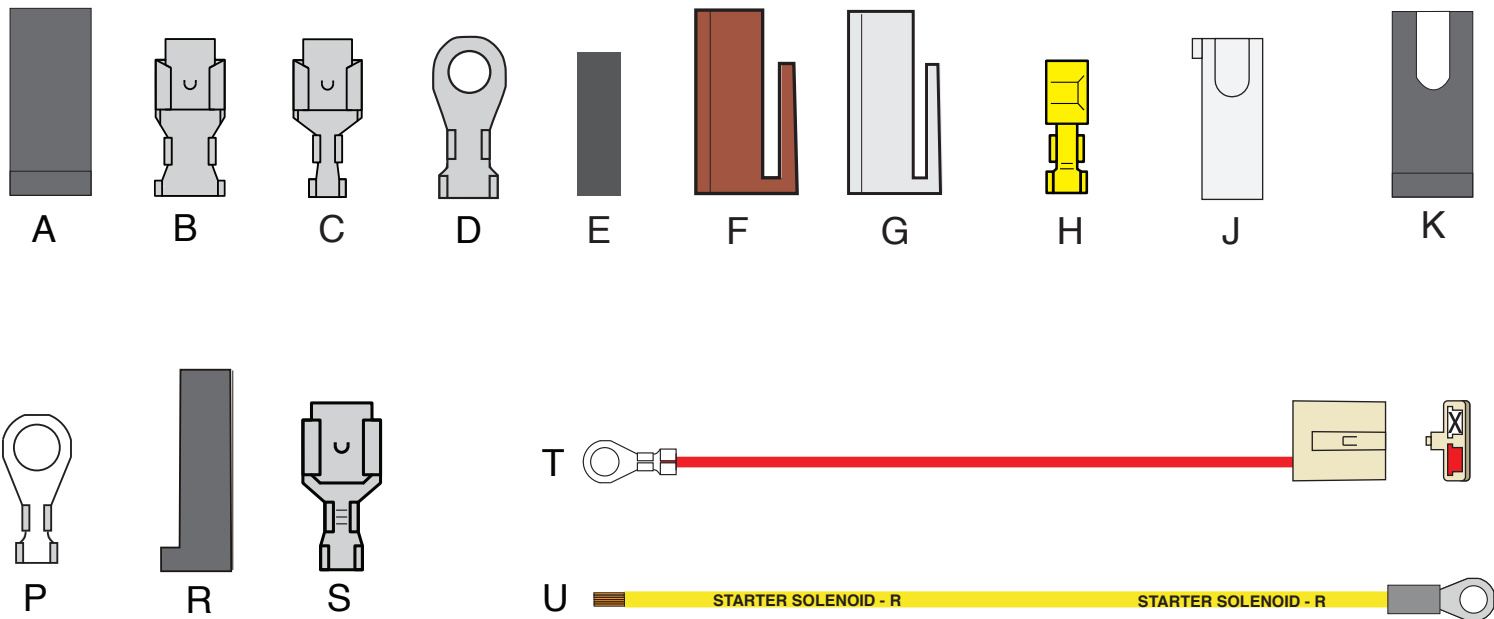

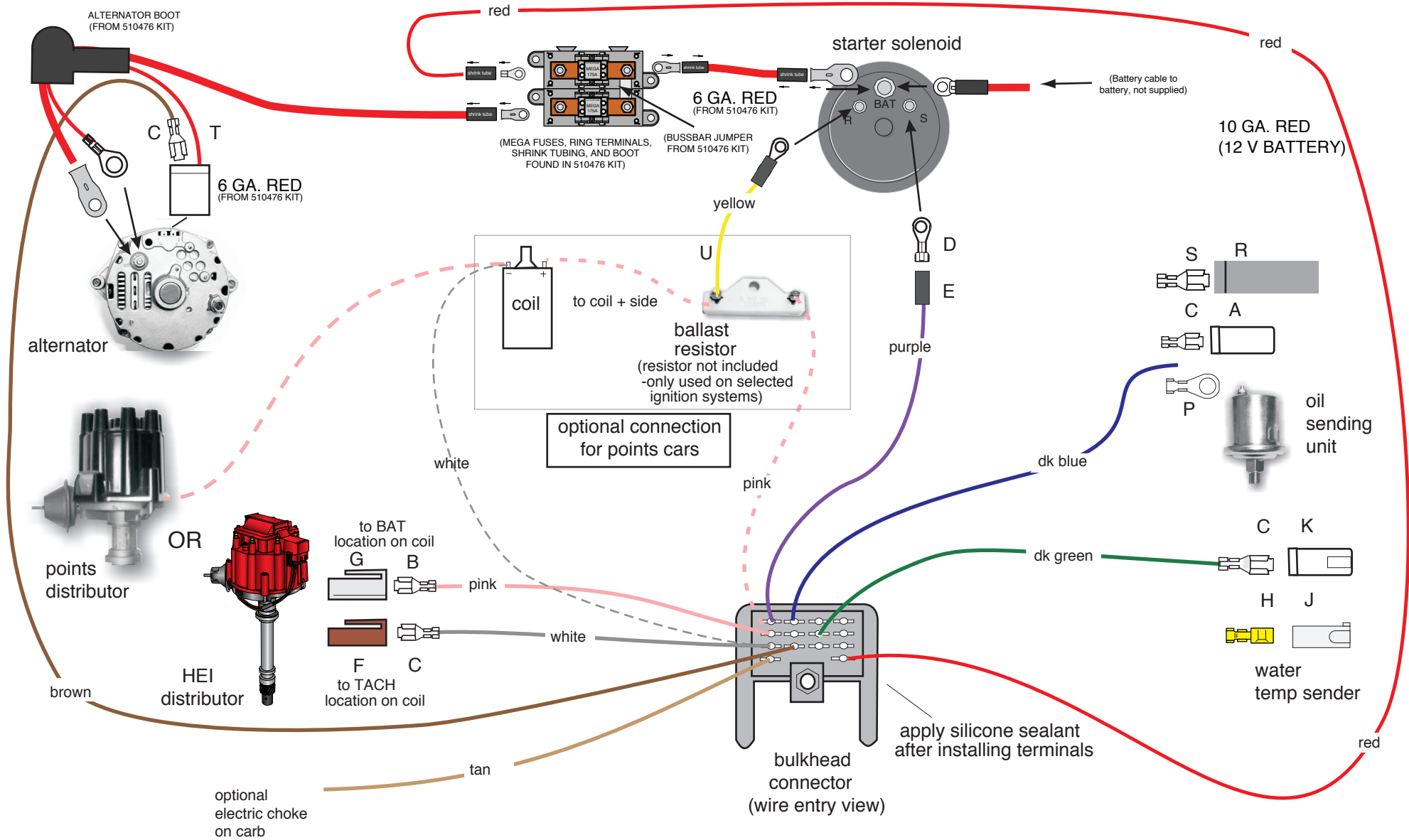

**ENGINE KIT**  
**510496**  
 92972382 instruction rev 0.0 4/9/2019



TEMPORARILY, PLUG THE MAIN BULKHEAD CONNECTOR FROM THIS KIT INTO THE MATING CONNECTOR ON THE DASH BULKHEAD CONNECTOR (LOCATED UNDER THE MASTER CYLINDER). Note: This will be unbolted to install the front light harness later.

BULKHEAD CONNECTOR WIRES:

RED	12V BATTERY	Route this wire to the Megafuse and cut to length. Use ring terminal, shrink tubing from 510476 kit. Connect as shown on page 3.
PURPLE	STARTER SOLENOID	Route to the starter solenoid and cut to length. Install rubber sleeve E and ring D. Connect to the 'S' terminal on solenoid.
DK BLUE	OIL PRESSURE SENDER	Connect this wire to the oil pressure sending unit. The terminal and connector size changed throughout the years. Depending on the terminal size of the sender unit, you will use terminal R with connector S, terminal C with connector A, or terminal P.
DK GREEN	WATER TEMP SENDER	Route this wire to the water temp switch, trim to length, install terminal C, and plug into connector K. If you are using a pin type sender, install terminal H and plug into connector J.
PINK	12V IGNITION	If using an HEI distributor, or after-market ignition system which requires a 12V feed: Route the PINK wire to the coil and trim to length. Install terminal B and connector G, and plug into distributor cap BAT location.
PINK	12V IGNITON	If using a points type ignition system which requires reduced voltage, the following wires will be used: Route this PINK wire to the ignition feed side of the ballast resistor. Connect a piece of left over PINK wire to the coil side of the ballast resistor and route this to the distributor coil + side.
YELLOW	STARTER SOLENOID-R	Connect this loose piece YELLOW (STARTER SOLENOID-R) wire U to the R terminal on the starter. Connect the other end to the coil side of the ballast resistor (not included).
BROWN	ALTERNATOR IGN	<b>NOTE:</b> This wire is only used on an alternator with an internal regulator which requires an exciter wire. If you are using a true one wire alternator, then this brown wire will not be used and can be removed. Route this wire to the alternator, cut to length, install terminal C, and plug into the regulator connector with red wire T. (See small RED wire directions below).
WHITE	COIL-TACH	Route this wire to the coil and trim to length. If using an HEI distributor, terminal C and connector F are included for connection to the TACH location. If using a conventional coil, terminal P is included for connection to the negative side of coil. If you are not using a tachometer, remove this wire from the engine bulkhead connector
TAN	ELECTRIC CHOKE	If you are using a carburetor with an electric choke, connect this wire to the electric choke connection. If you are not using an electric choke or a turbo 400 transmission, remove this wire from the engine bulkhead connector.
ALTERNATOR		
RED Heavy	not printed	Use the 6 gauge red wire, boot and ring terminals from the 510476 kit. Route the 6ga red wire from alternator to the Megafuse and cut to length. Connect as shown on page 3.
RED small	not printed	Send the ring terminal end of this red wire T through boot (as shown on page 3) and connect to the battery stud on alternator. Do not plug the connector into the alternator yet, the exciter wire will be added when the front light wires are installed.

Once the main connector has all of its wires plugged in, the connector cavities should be sealed with di-electric grease on the terminals. Also, to assure a moisture resistant seal, silicone can be applied to seal the outside of the connector.

**ENGINE KIT**

**510496**

92972382 instruction rev 0.0 4/9/2019

# Classic Update Series

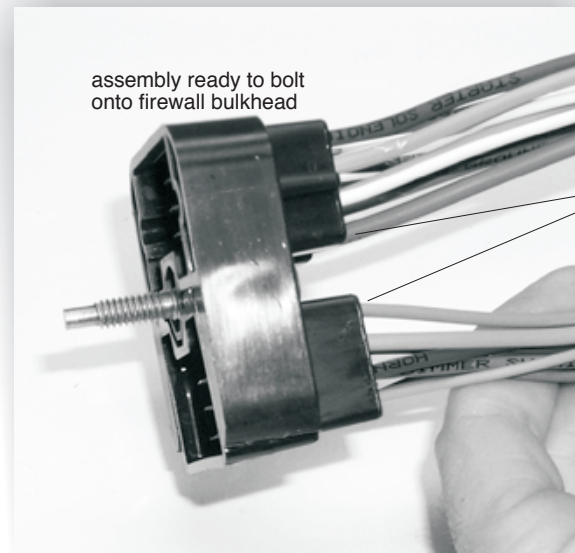
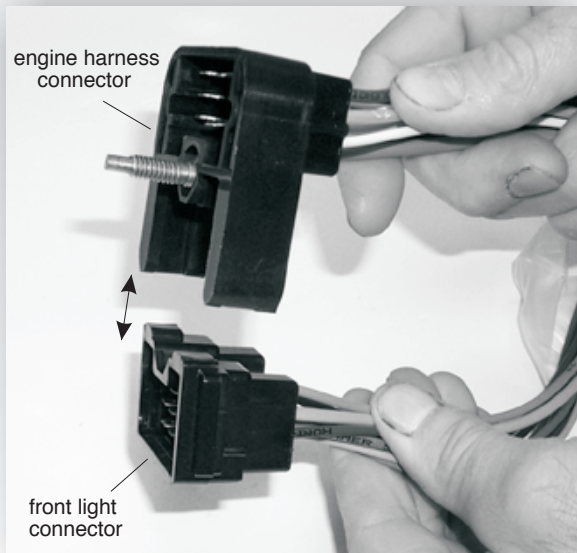

The bulkhead connector from this FRONT LIGHT KIT must snap into the mating ENGINE KIT connector (bag J), as shown. After snapping together, bolt the assembly into the dash harness firewall connector using the attached bolt.

Look!



American Autowire also sells factory OEM style harness wrap. this is the same stuff used on original Camaro harnesses! If you want that OEM look with your Classic Update wiring system, then give us a call and order p/n R0067108 !



**American  
Autowire**

American Autowire  
800-482-9473



Terminals used in this installation.

This kit contains loose piece terminals and connectors necessary to complete a connection to a specific component. Each connection on the instruction sheet identifies specific parts by a letter code that corresponds to the letter code on a part picture identified below. The parts below are shown in actual size to help in identification. This kit will only contain those parts required for the connections in the specific sub-kit you are working on. Just match the part to the picture below to identify the part letter code you will see on the instruction sheet for the sub-kit harness you are working on. We have supplied additional terminals in the event that extra terminals are necessary.

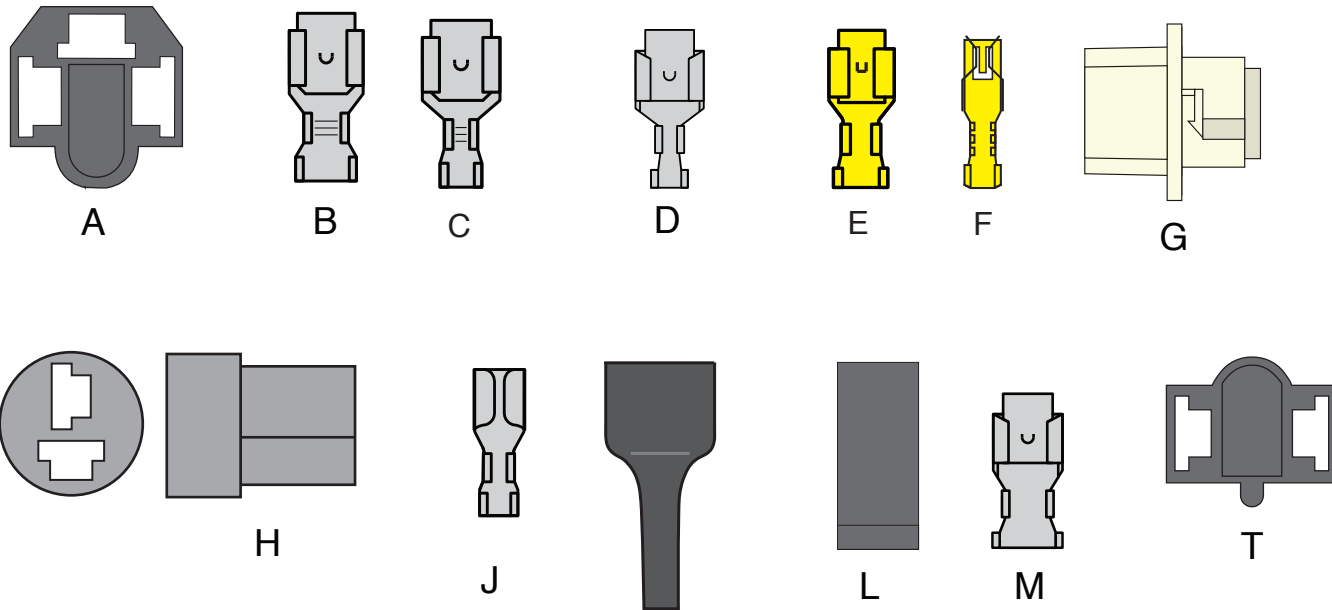

Front Light Kit  
**510497**  
92972384 instruction rev 0.0 5/21/2019

# Classic Update Series

right headlight

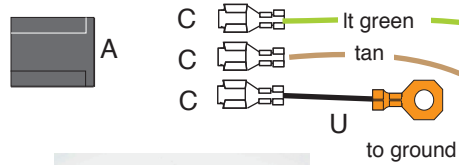

left headlight

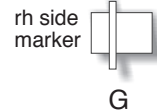

rh side marker

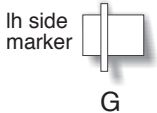
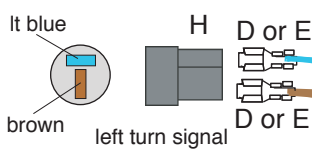
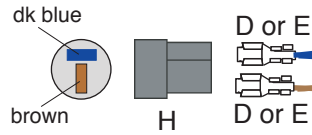

lh side marker

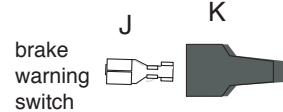
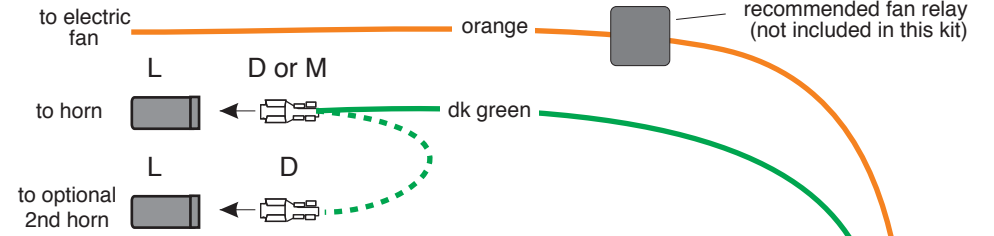

brake warning switch

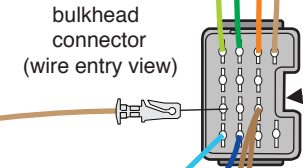

bulkhead connector (wire entry view)

apply silicone sealant to back side of connector after installing terminals

1969-72 Chevy Front Light

Front Light Kit  
**510497**  
92972384 instruction rev 0.0 5/21/2019

## 1969-1972 CHEVY TRUCK

Connect the bulkhead connector from this kit onto the bulkhead connector from the engine kit (bag J), and bolt to the firewall dash bulkhead. After all wires are installed from this kit, the main connector should have die-electric grease applied to the terminals and silicone sealer applied to the outside of the connectors as a moisture seal.

### BULKHEAD CONNECTOR WIRES:

LT BLUE	LH TURN	Route this wire to the LH turn signal lamp, cut to length and if no side marker is used, install terminal D and plug into connector H as shown on sheet 3. If using side markers, take cut off piece, double with original wire, install terminal E, plug into connector H, route other end to side marker, install terminal F and plug into connector G as shown on sheet 3.
DK BLUE	RH TURN	Route this wire to the RH turn signal lamp, cut to length and if no side marker is used, install terminal D and plug into connector H as shown on sheet 3. If using side markers, take cut off piece, double with original wire, install terminal E, plug into connector H, route other end to side marker, install terminal F and plug into connector G as shown on sheet 3.
BROWN	PARKING LAMP	Route the shorter brown wire that is the same length as the LT BLUE wire to the LH turn signal lamp, cut to length and if no side marker is used, install terminal D and plug into connector H as shown on sheet 3. If using side markers, take cut off piece, double with original wire, install terminal E, plug into connector H, route other end to side marker, install terminal F and plug into connector G as shown on sheet 3. Route the longer brown wire that is the same length as the DK BLUE wire to the RH turn signal lamp, cut to length and if no side marker is used, install terminal D and plug into connector H as shown on sheet 3. If using side markers, take cut off piece, double with original wire, install terminal E, plug into connector H, route other end to side marker, install terminal F and plug into connector G as shown on sheet 3.
TAN	HEADLIGHT LO BEAM	Route this wire to the driver side headlight and trim to length. Double this wire with the cutoff portion, and install terminal B. Plug this terminal into connector A as shown on sheet 3. Route the remaining portion of this TAN wire to the passenger side outer headlight and trim to length. Install terminal C and plug into connector A as shown on sheet 3.
LT GREEN	HEADLIGHT	Route this wire to the driver side headlight and trim to length, double this wire with the cutoff portion, install terminal B, and plug this terminal into connector A as shown on sheet 3. Route the remaining portion of this LT GREEN wire to the passenger side headlight, trim to length, install terminal C, and plug into connector A as shown on sheet 3.
TAN	BRAKE LIGHT SWITCH	Plug this tan wire V into the front light connector as shown on sheet 3. Route the other end of this wire to the brake warning switch, trim to length, slide boot K onto wire, install terminal J, then pull boot K back up over terminal J.
BLACK	GROUND	Route one ground wire U to the driver side headlight trim to length, install terminal C, and plug into connector A as shown on sheet 3. Repeat this process for passenger side headlight connection.

### OTHER WIRING:

DK GREEN	HORN	Route to horn, install terminal D, and plug into connector L as shown on sheet 3.
ORANGE	ELECTRIC FAN	Route to the electric fan and connect per manufacturer's instructions. NOTE: This wire is designed to be the trigger wire for the electric fan relay.

Front Light Kit

**510497**

92972384 instruction rev 0.0 5/21/2019

# Classic Update Series

right headlight

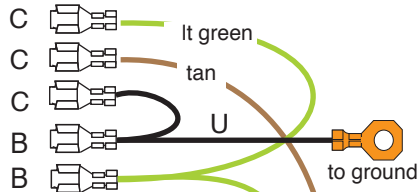
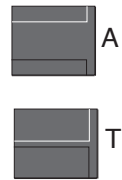

left headlight

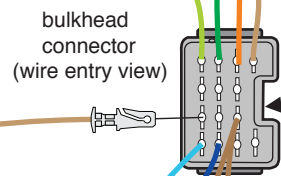
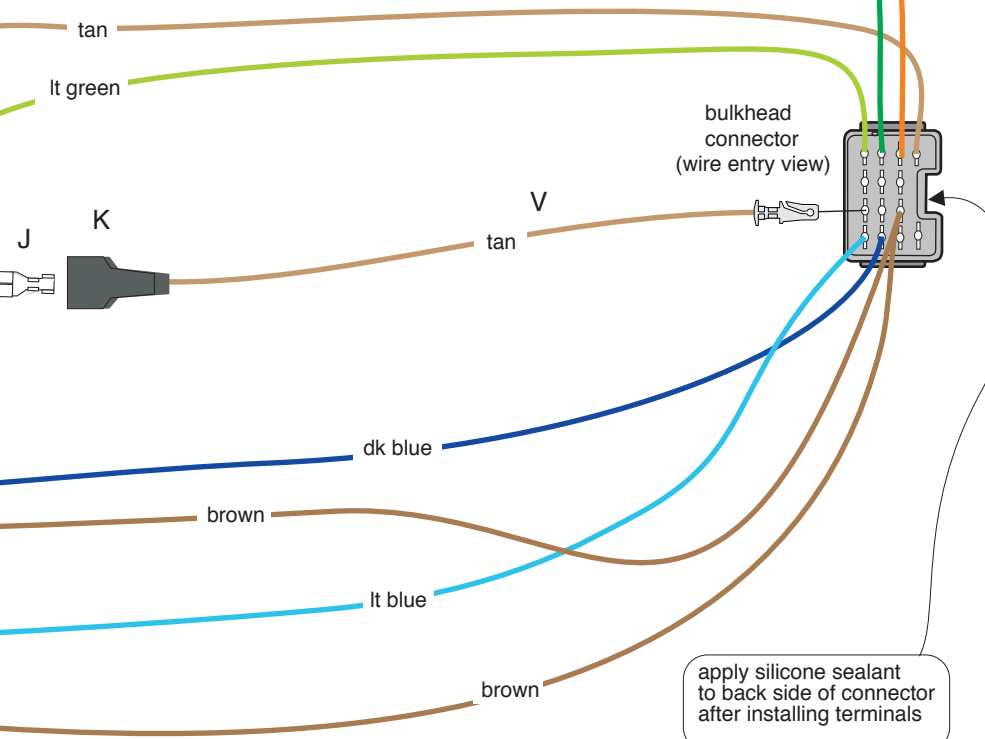
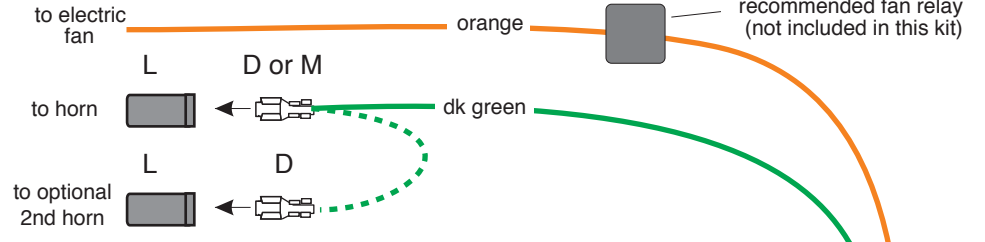
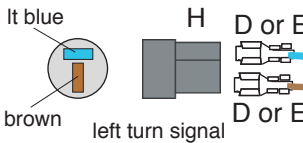
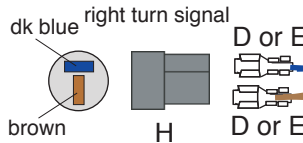
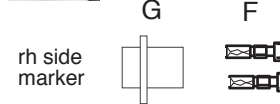
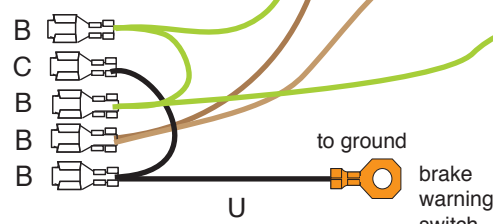
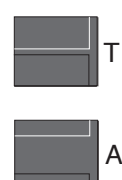

apply silicone sealant to back side of connector after installing terminals

1969-72 GMC Front Light

Front Light Kit  
**510497**  
 92972384 instruction rev 0.0 5/21/2019

## 1969-1972 GMC TRUCK

Connect the bulkhead connector from this kit onto the bulkhead connector from the engine kit (bag J), and bolt to the firewall dash bulkhead. After all wires are installed from this kit, the main connector should have die-electric grease applied to the terminals and silicone sealer applied to the outside of the connectors as a moisture seal.

### BULKHEAD CONNECTOR WIRES:

LT BLUE	LH TURN	Route this wire to the LH turn signal lamp, cut to length and if no side marker is used, install terminal D and plug into connector H as shown on sheet 5. If using side markers, take cut off piece, double with original wire, install terminal E, plug into connector H, route other end to side marker, install terminal F and plug into connector G as shown on sheet 5.
DK BLUE	RH TURN	Route this wire to the RH turn signal lamp, cut to length and if no side marker is used, install terminal D and plug into connector H as shown on sheet 5. If using side markers, take cut off piece, double with original wire, install terminal E, plug into connector H, route other end to side marker, install terminal F and plug into connector G as shown on sheet 5.
BROWN	PARKING LAMP	Route the shorter brown wire that is the same length as the LT BLUE wire to the LH turn signal lamp, cut to length and if no side marker is used, install terminal D and plug into connector H as shown on sheet 5. If using side markers, take cut off piece, double with original wire, install terminal E, plug into connector H, route other end to side marker, install terminal F and plug into connector G as shown on sheet 5. Route the longer brown wire that is the same length as the DK BLUE wire to the RH turn signal lamp, cut to length and if no side marker is used, install terminal D and plug into connector H as shown on sheet 5. If using side markers, take cut off piece, double with original wire, install terminal E, plug into connector H, route other end to side marker, install terminal F and plug into connector G as shown on sheet 5.
TAN	HEADLIGHT LO BEAM	Route this wire to the driver side outer headlight and trim to length. Double this wire with the cutoff portion, and install terminal B. Plug this terminal into connector A as shown on sheet 5. Route the remaining portion of this TAN wire to the passenger side outer headlight and trim to length. Install terminal C and plug into connector A as shown on sheet 5.
LT GREEN	HEADLIGHT HIGH BEAM	Route this wire to the driver side outer headlight and trim to length. Double this wire with the cutoff portion, and install terminal B. Plug this terminal into connector A, make a short jumper over to the driver side inner headlight, cut to length, double it with the cutoff portion, install terminal B, and plug it into connector T as shown on sheet 5. Route the remaining portion of this LT GREEN wire to the passenger side inner headlight and trim to length, double this wire with the cutoff portion, install terminal B and plug into connector T as shown, make a short jumper over to the passenger side outer headlight, cut to length, double it with the cutoff portion, install terminal C, and plug it into connector A as shown on sheet 5.
TAN	BRAKE LIGHT SWITCH	Plug this tan wire V into the front light connector as shown on sheet 5. Route the other end of this wire to the brake warning switch, trim to length, slide boot K onto wire, install terminal J, then pull boot K back up over terminal J.
BLACK	GROUND	Route this wire U to the driver side outer headlight and trim to length, double this wire with the cutoff portion, install terminal B, plug this terminal into connector A, take the short jumper over to the driver side inner headlight, cut to length, install terminal C, and plug it into connector T in the location shown on sheet 5. Repeat this process for the passenger side.

### OTHER WIRING:

DK GREEN	HORN	Route to horn, install terminal D, and plug into connector L as shown on sheet 5.
ORANGE	ELECTRIC FAN	Route to the electric fan and connect per manufacturer's instructions. NOTE: This wire is designed to be the trigger wire for the electric fan relay.

Front Light Kit

**510497**

92972384 instruction rev 0.0 5/21/2019

A  (1)  
 (144.0" 6 Gauge charge wire)

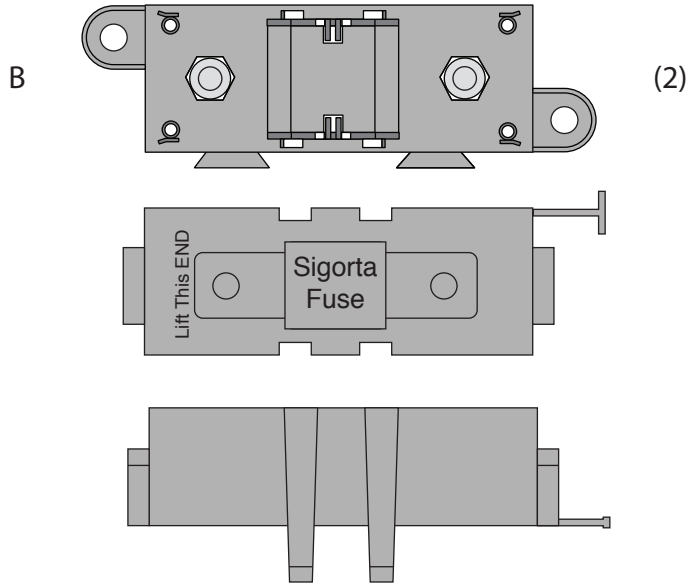

1. On this page, you will find the wire, fuse bodies, fuses, boot, ring terminals, and shrink tubing (items A through K) that are necessary to connect your alternator and main power feed for your new AAW wiring kit. Please be sure that all of the necessary components are present before starting this portion of your installation. If anything is missing, stop what you are doing and contact AAW at the number listed below right away.

2. On page 2, you will find directions for building the 2 Megafuse assemblies (items B,C and D) into one unit.

3. On page 3, you will find an overall concept of how to connect the Megafuse assemblies to your starter solenoid, alternator and main power feed of your new wiring system.

4. On page 4, you will find tips on building your charging circuit wires and assembling them and the main panel power feed wire to the Megafuse assemblies.

(Megafuse body, cover and two M8 x 1.25 nuts / lock washers)

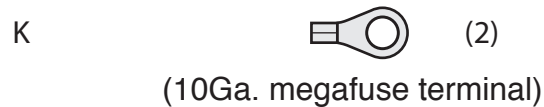
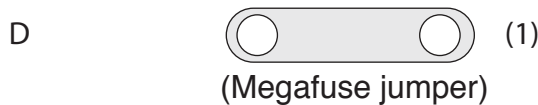
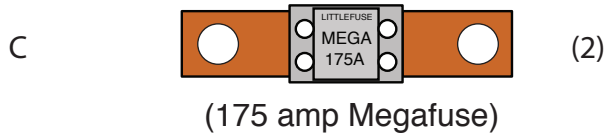

www.americanautowire.com 856-933-0801

PART #

510476

Z

DESCRIPTION:

Alternator and Main Power  
 Connection Kit  
 Various Applications

92972153 instruction sheet rev 0.1 6/24/2019



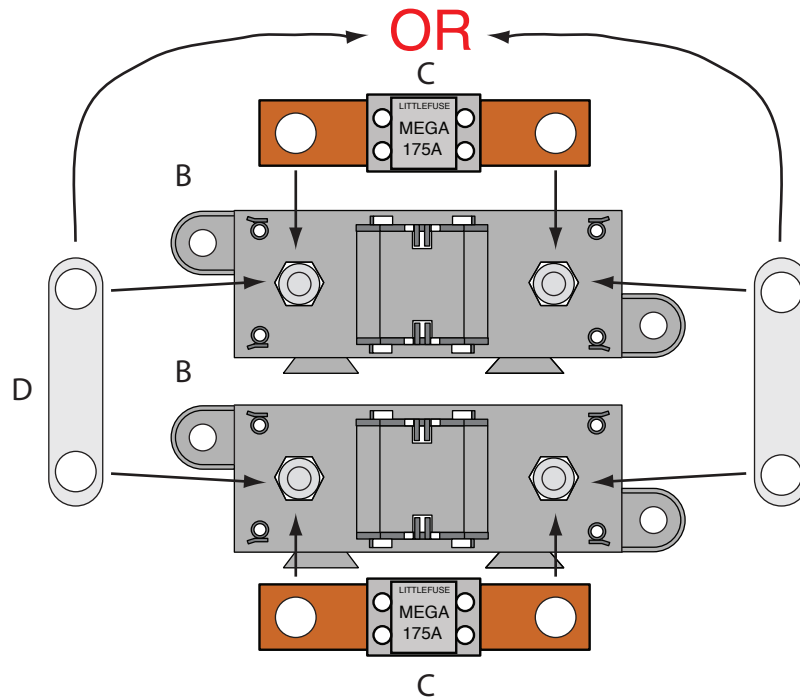

## Assembling the (2) Megafuse assemblies

**NOTE:** Find a suitable place, as close to the battery power source as possible, under the hood of your vehicle to mount the completed Megafuse assemblies. Keep in mind that you have 12 feet of 6Ga. charging wire, and that the main power feed coming from your panel or bulkhead connection must also be able to reach the assembly.

1. Take the two Megafuse bodies and covers (items B) and snap them together. Remove the 4 nuts and lock washers from the studs on the fuse body assemblies.
2. Install the Megafuse jumper (item D above) over two of the studs on the Megafuse bodies. It is very important that the jumper **MUST BE** assembled on the side that is going to connect to your main power connection (starter solenoid or battery feed).
3. Notch top cover to clear jumper D as shown at right.
4. Snap one 175amp fuse (items C) onto the studs of each of the two Megafuse bodies (items B), over the jumper, then loosely re-attach the 4 nuts and lock washers back onto the assembled Megafuses. The fuse assemblies are ready to install into your vehicle.

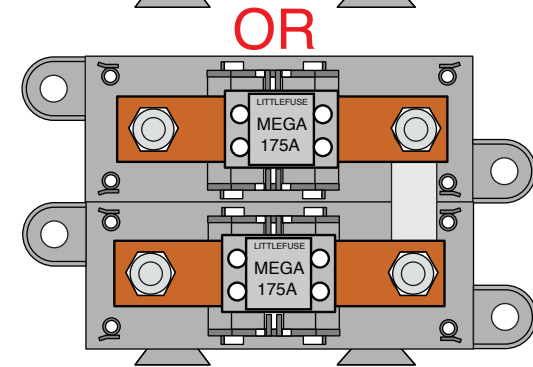
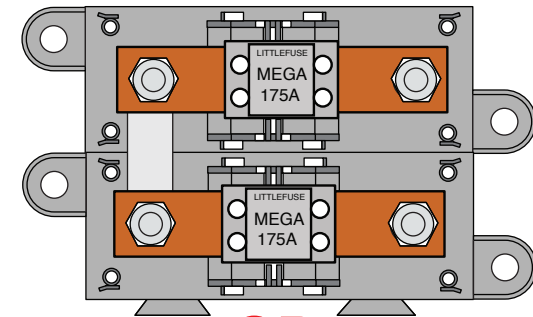

## Assembled Megafuses

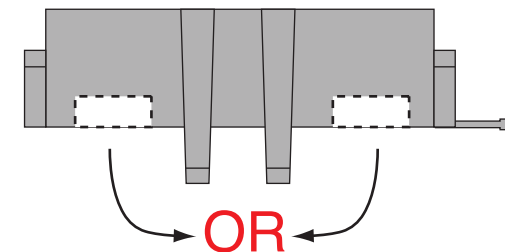

## Notched Cover

PART #

**510476**

**Z**

DESCRIPTION:

Alternator and Main Power  
Connection Kit  
Various Applications

92972153 instruction sheet rev 0.1 6/24/2019

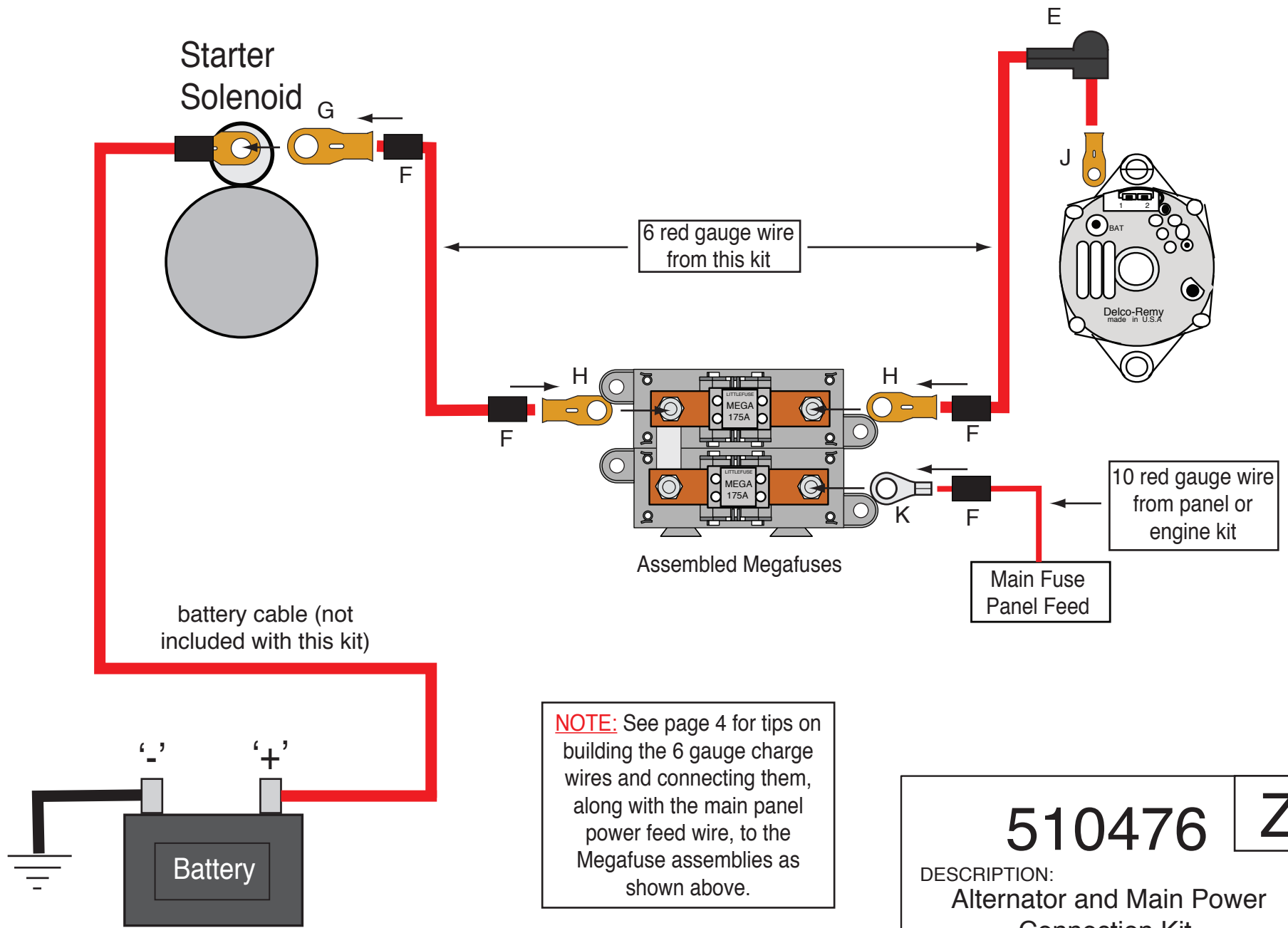

**NOTE:** See page 4 for tips on building the 6 gauge charge wires and connecting them, along with the main panel power feed wire, to the Megafuse assemblies as shown above.

<h1>510476</h1>	<b>Z</b>
<p>DESCRIPTION:  <b>Alternator and Main Power Connection Kit</b>  <b>Various Applications</b></p>	
<p>92972153 instruction sheet rev 0.1 6/24/2019</p>	

## **Building the 6Ga. charge wires and connecting them and the main panel power feed wire to the Megafuse assemblies:**

**NOTE:** Make sure that your battery is disconnected! You will need to install the preassembled Megafuses from page 2 in your vehicle to start this part of the installation.

1. Pre-cut item F shrink tubing into (6) 1.00" - 1.25" pieces.
2. Take the 12-foot piece of 6Ga. red wire from this kit and route it from your starter (or other battery feed) over to the area where you have mounted your Megafuse and cut it to length. Strip the insulation on each end back 1/2". Install 2 pieces of shrink tubing F onto the wire. At the starter end, crimp and solder (1) of terminal G onto the wire. At the Megafuse end, crimp and solder (1) of terminal H onto the wire. Slide the shrink tubing over the terminals and heat it up to shrink it down.
3. Take the remaining portion of the 12-foot piece of 6Ga. red wire from this kit and route it from your alternator over to the area where you have mounted your Megafuse and cut it to length. Strip the insulation on each end back 1/2". Install 1 piece of shrink tubing F onto the wire. At the alternator end, slip on boot E as shown on page 3, then crimp and solder (1) of terminal J onto the wire. At the Megafuse end, crimp and solder (1) of terminal H onto the wire. Slide the shrink tubing over terminal H and heat it up to shrink it down.
4. Take the 10Ga. red main power feed wire from your engine or panel sub-kit and route it over to the area where you have mounted your Megafuse and cut it to length. Strip the insulation back 3/8". Install 1 piece of shrink tubing F onto the wire, then crimp and solder (1) of terminal K onto the wire.
5. Remove the 4 loosely tightened nuts and lock washers from the assembled Megafuses, then using the drawing on page 3 as a guide, install your pre-assembled wires from steps 2-4 above. Re-install the 4 nuts and lock washers onto the assembled Megafuses and tighten them down. This part of your installation is now complete.

**510476**

**Z**

DESCRIPTION:

**Alternator and Main Power  
Connection Kit  
Various Applications**

92972153 instruction sheet rev 0.1 6/24/2019

# Classic Update Series

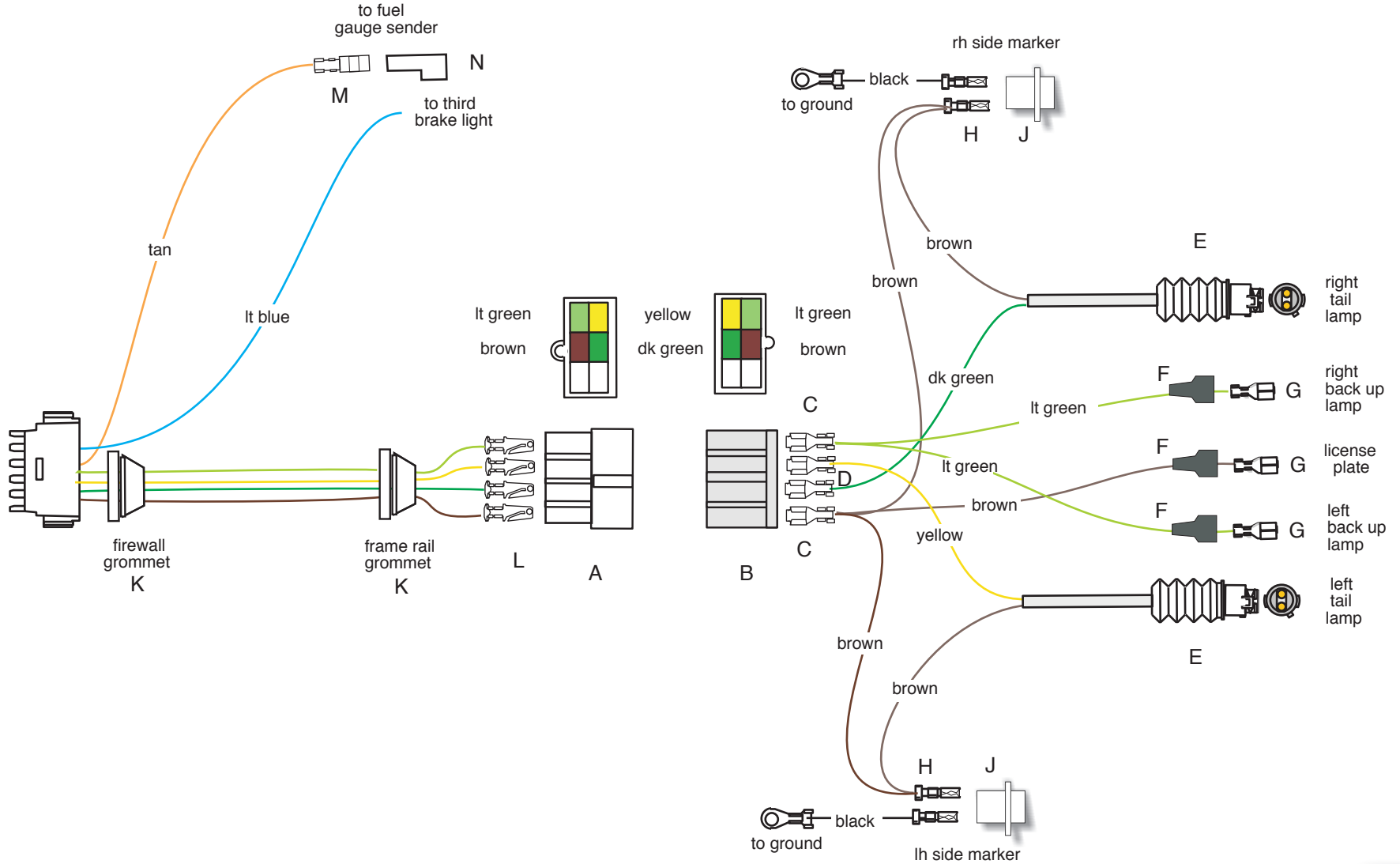

USE THIS SHEET FOR  
67-72 FLEETSIDE MODELS

sheet 1



**American  
Autowire**

American Autowire / Factory-Fit  
800-482-9473

Classic Update Series bag  
**M**  
1967-72 CHEVY  
AND GMC TRUCK  
**REAR BODY KIT**  
**510095**  
92969115 instruction rev 1.0 12/9/2013

## USE THIS SHEET FOR ALL 1967-72 FLEETSIDE MODELS

Connect the main connector to the mating connector on the dash harness 510091 bag G. After completing the installation of this portion of the kit, it is recommended that you seal the back of the cavities of Connectors A and B with black silicone sealer.

**NOTE:** There are 2 grommets K included in this bag. 1 installs from inside the cab through the firewall in the stock location, the other installs in the rear frame rail in the stock position installing toward the back of the truck. You will need to ream out the hole in the center of the grommets depending on how many wires you install through them.

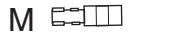
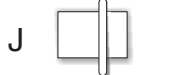
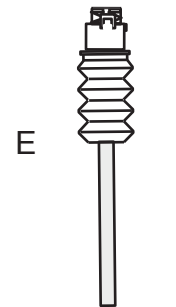
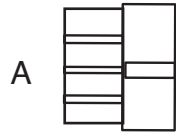

**LIGHT BLUE** Third brake light Connect to the third brake lamp, if equipped. If your third brake light is at the back of the truck, you may route this wire out of the cab through the grommets with the other wires that run to the back of the truck.

**TAN** Fuel Tank lead Route this wire over to the driver side sill area, up behind the seat assembly to the fuel tank, cut to length, install terminal M, plug into connector N, and install onto the fuel tank sending unit. If you are running a modified fuel system and have moved your tank to the outside of the truck you may route this wire out of the cab through the grommets with the other wires that run to the back of the truck.

The following steps will complete the forward half of your rear body connection as seen on sheet 1.

**BROWN** Parking lamps Route this wire through the grommet in the firewall, along the driver side frame rail to the back of the truck, through the rear grommet, cut to length, install terminal L and plug into connector A as shown on sheet 1.

**YELLOW** LH Stop / Tail Route this wire through the grommet in the firewall, along the driver side frame rail to the back of the truck, through the rear grommet, cut to length, install terminal L and plug into connector A as shown on sheet 1.

**DK GREEN** RH Stop / Tail Route this wire through the grommet in the firewall, along the driver side frame rail to the back of the truck, through the rear grommet, cut to length, install terminal L and plug into connector A as shown on sheet 1.

**LIGHT GREEN** Back up lamp feed Route this wire through the grommet in the firewall, along the driver side frame rail to the back of the truck, through the rear grommet, cut to length, install terminal L and plug into connector A as shown on sheet 1.

**NOTE:** On the Fleetside models, you have 2 tail lamp boot, tube, and socket pigtails containing the parking lamp and stop/turn lamp wires that will plug onto the back of your tail lamp housing assemblies. These pigtails, once installed, should be fished down through the verticle channel that the lamp assembly mounts into and the wires are to be pulled down through the bottom of that channel and be left there to hang for now.

**BROWN** Parking lamps Route the loose piece brown wire included in this bag from the tag lamp assembly to the rear body connection area and cut to length. On one end, slide boot F onto wire, install terminal G, then pull boot F over terminal G to seat it as shown on sheet 1. The other end of this wire will be tripled at the rear body connection area later.

If you ARE NOT using side marker lamps, take the brown wires from the tail lamp pigtails, route them to the rear body connection area and cut to length. Take these 2 wires along with the tag lamp wire previously completed, triple them together in terminal C (brass color, soldering is recommended here), and plug them into connector B as shown on sheet 1.

If you ARE using side marker lamps, take the remaining portion of the loose piece brown wire and route it from the LH side marker assembly to the rear body connection area and cut to length. Route the brown wire from the LH tail lamp pigtail over to the LH side marker lamp, cut to length, double it with the loose piece wire that was just cut for the LH side marker lamp, install terminal H (the wider of the 2 styles), and plug it into the lamp socket J as shown on sheet 1. Take the remaining portion of the loose piece brown wire and route it from the RH side marker assembly to the rear body connection area and cut to length. Route the brown wire from the RH tail lamp pigtail over to the RH side marker lamp, cut to length, double it with the loose piece wire that was just cut for the RH side marker lamp, install terminal H (the wider of the 2 styles), and plug it into the lamp socket J as shown on sheet 1. Take these 2 wires along with the tag lamp wire previously completed, triple them together in terminal C (brass color, soldering is recommended here), and plug them into connector B as shown on sheet 1.

**YELLOW** LH Stop / Tail Route this wire from the LH tail lamp pigtail assembly over to the rear body connection area, cut to length, install terminal D (silver color), and plug into connector B as shown on sheet 1.

**DK GREEN** RH Stop / Tail Route this wire from the RH tail lamp pigtail assembly over to the rear body connection area, cut to length, install terminal D (silver color), and plug into connector B as shown on sheet 1.

**LIGHT GREEN** Back up lamp feed Route the loose piece lt green wire included in this bag from the LH back up lamp assembly to the rear body connection area and cut to length. On one end, slide boot F onto wire, instal terminal G, then pull boot F over terminal G to seat it as shown on sheet 1 then plug it into the LH back up lamp assembly. Repeat this procedure for RH side back up lamp assembly. Take these 2 wires and double them together in terminal C (brass color, soldering is recommended here), and plug them into connector B as shown on sheet 1.

**BLACK** Side Marker Ground There are two loose black wires in this bag that are already terminated on both ends. Plug each of them into the LH and RH rear side marker lamp sockets J as shown on sheet 1 and ground the other end to the inside of the rear bed assembly.

# Classic Update Series

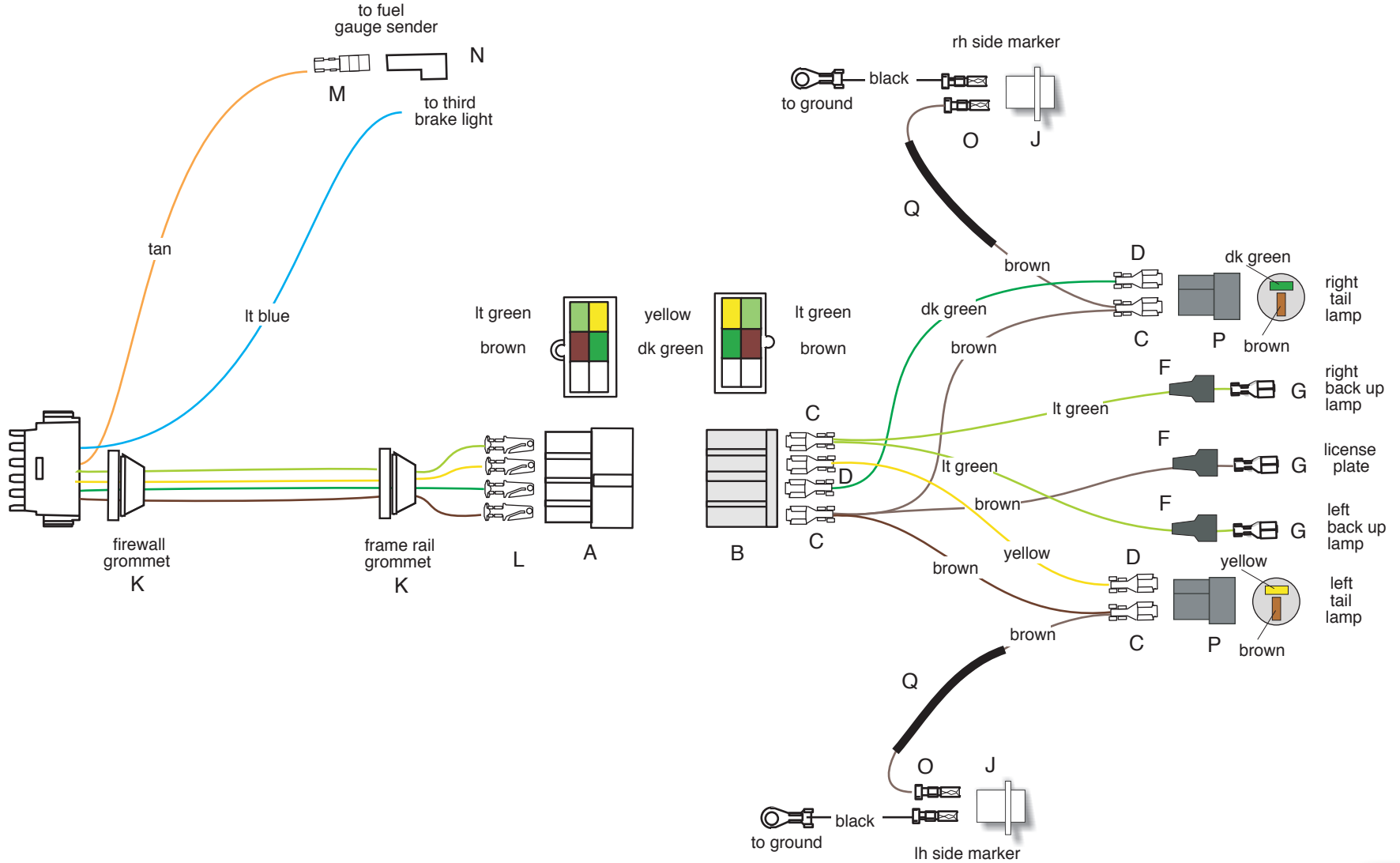

USE THIS SHEET FOR  
69-72 STEPSIDE MODELS  
(FOR 67-68 STEPSIDE MODELS,  
SEE SHEET 4 OF THE  
92970116 INSTRUCTION SET)



**American  
Autowire**

American Autowire / Factory-Fit  
800-482-9473

Classic Update Series bag  
1967-72 CHEVY  
AND GMC TRUCK M  
REAR BODY KIT  
**510095**  
92969115 instruction rev 1.0 12/9/2013

## USE THIS SHEET FOR ALL 1967-72 STEPSIDE MODELS (FOR 67-8 STEPSIDES, ALSO SEE INSTRUCTION SET 92970116, SHEET 4)

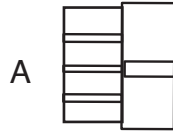

A

Connect the main connector to the mating connector on the dash harness 510091 bag G. After completing the installation of this portion of the kit, it is recommended that you seal the back of the cavities of Connectors A and B with black silicone sealer.



B

NOTE: There are 2 grommets K included in this bag. 1 installs from inside the cab through the firewall in the stock location, the other installs in the rear frame rail in the stock position installing toward the back of the truck. You will need to ream out the hole in the center of the grommets depending on how many wires you install through them.



C

LIGHT BLUE Third brake light

Connect to the third brake lamp, if equipped. If your third brake light is at the back of the truck, you may route this wire out of the cab through the grommets with the other wires that run to the back of the truck.



D

TAN Fuel Tank lead

Route this wire over to the driver side sill area, up behind the seat assembly to the fuel tank, cut to length, install terminal M, plug into connector N, and install onto the fuel tank sending unit. If you are running a modified fuel system and have moved your tank to the outside of the truck you may route this wire out of the cab through the grommets with the other wires that run to the back of the truck.

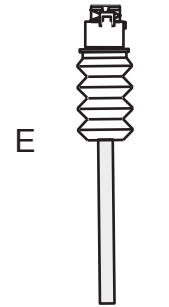

E

BROWN Parking lamps  
YELLOW LH Stop / Tail  
DK GREEN RH Stop / Tail  
LIGHT GREEN Back up lamp feed

The following steps will complete the forward half of your rear body connection as seen on sheet 1.

Route this wire through the grommet in the firewall, along the driver side frame rail to the back of the truck, through the rear grommet, cut to length, install terminal L and plug into connector A as shown on sheet3.  
Route this wire through the grommet in the firewall, along the driver side frame rail to the back of the truck, through the rear grommet, cut to length, install terminal L and plug into connector A as shown on sheet3.  
Route this wire through the grommet in the firewall, along the driver side frame rail to the back of the truck, through the rear grommet, cut to length, install terminal L and plug into connector A as shown on sheet3.  
Route this wire through the grommet in the firewall, along the driver side frame rail to the back of the truck, through the rear grommet, cut to length, install terminal L and plug into connector A as shown on sheet3.



F

NOTE: On the Stepside models, you must build the entire rear extension harness as you will NOT be using the rear pigtail assemblies.



G

BROWN Parking lamps

Route the loose piece brown wire included in this bag from the tag lamp assembly to the rear body connection area and cut to length. On one end, slide boot F onto wire, install terminal G, then pull boot F over terminal G to seat it as shown on sheet3. The other end of this wire will be tripled at the rear body connection area later.



H

If you ARE NOT using side marker lamps, route the remaining portion of the loose piece brown wire from LH tail lamp assembly to the rear body connection area and cut to length, install terminal D (silver color), and plug it into connector P as shown on sheet3. Repeat this procedure for the RH tail lamp assembly. Triple the 3 brown wires together in terminal C (brass color, soldering is recommended here), and plug them into connector B as shown on sheet3.

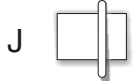

J

If you ARE using side marker lamps, take the remaining portion of the loose piece brown wire and route it from the LH tail lamp assembly to the rear body connection area and cut to length. Route the remaining portion of the loose piece brown wire from the LH tail lamp assembly over to the LH side marker lamp, cut to length, slide through loom Q, install terminal O (the narrower of the 2 styles), and plug it into the LH side marker lamp socket J. Double the 2 loose piece brown wires at the LH tail lamp assembly in terminal C (brass color, soldering is recommended here), and plug them into connector P as shown on sheet3. Repeat this procedure for the RH tail lamp assembly. Triple the 3 brown wires together in terminal C (brass color, soldering is recommended here), and plug them into connector B as shown on sheet3.



K



L

YELLOW LH Stop / Tail

Route the loose piece yellow wire from the LH tail lamp assembly over to the rear body connection area, cut to length, install terminal D (silver color) on both ends, and plug into connectors B and P as shown on sheet3.

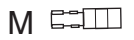

M

DK GREEN RH Stop / Tail

Route the loose piece dk green wire from the RH tail lamp assembly over to the rear body connection area, cut to length, install terminal D (silver color) on both ends, and plug into connectors B and P as shown on sheet3.



N



O

LIGHT GREEN Back up lamp feed

Route the loose piece lt green wire included in this bag from the LH back up lamp assembly to the rear body connection area and cut to length. On one end, slide boot F onto wire, install terminal G, then pull boot F over terminal G to seat it as shown on sheet 1 then plug it into the LH back up lamp assembly. Repeat this procedure for RH side back up lamp assembly. Take these 2 wires and double them together in terminal C (brass color, soldering is recommended here), and plug them into connector B as shown on sheet1.



P



Q

BLACK Side Marker Ground

There are two loose black wires in this bag that are already terminated on both ends. Plug each of them into the LH and RH rear side marker lamp sockets J as shown on sheet 1 and ground the other end to the inside of the rear bed assembly.

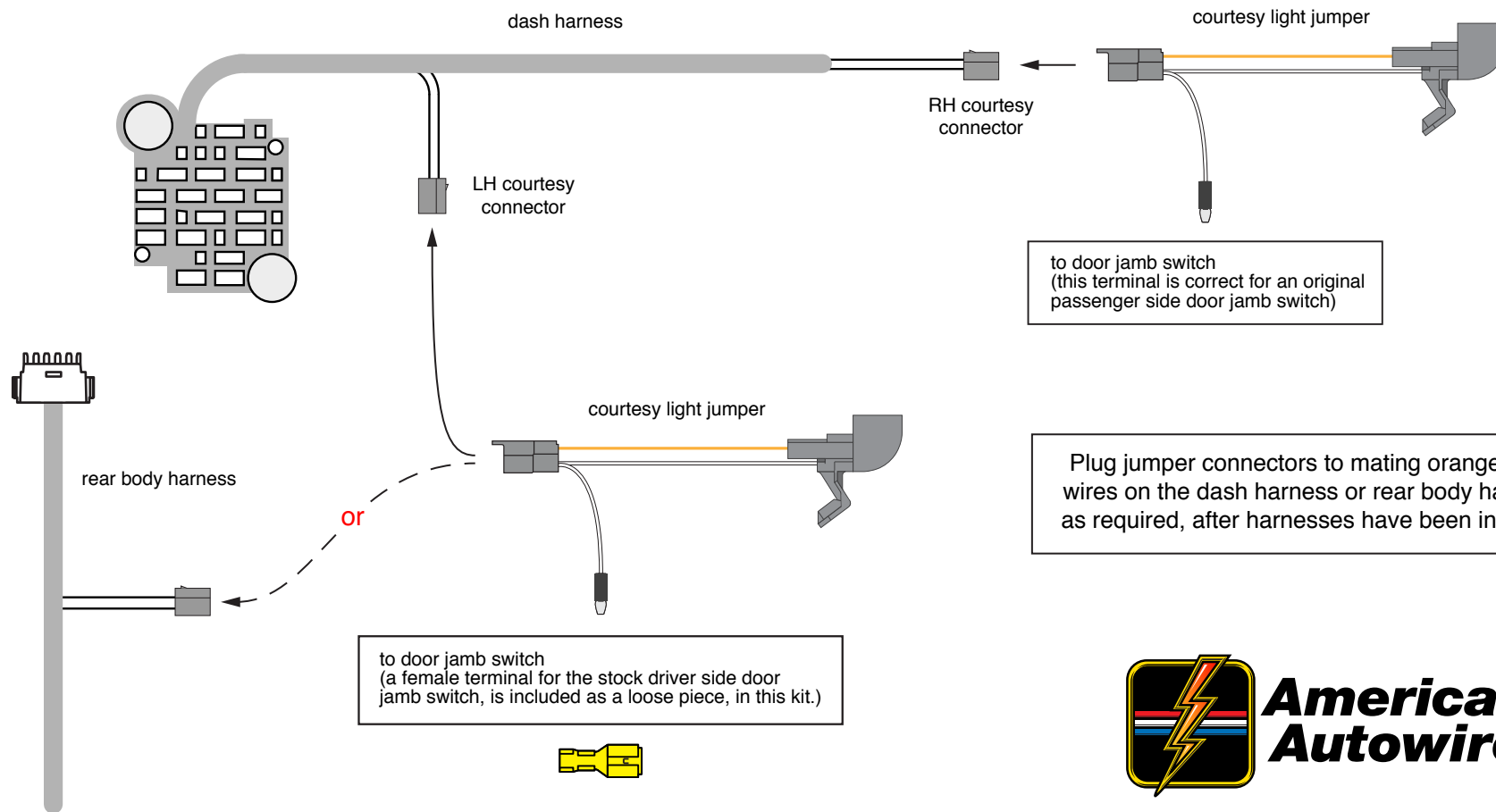

to door jamb switch  
(this terminal is correct for an original passenger side door jamb switch)

Plug jumper connectors to mating orange/white wires on the dash harness or rear body harness, as required, after harnesses have been installed.

to door jamb switch  
(a female terminal for the stock driver side door jamb switch, is included as a loose piece, in this kit.)



**American  
Autowire**

www.americanautowire.com 856-933-0801

**NOTE:** Your new underdash courtesy light kit uses # 631 bulbs (not included with this kit). They may be purchased at any auto parts store.

PART #	<b>500708</b>	<b>N</b>
DESCRIPTION:	<b>Courtesy Light Kit</b>	
92966085	Rev 1.1	6/27/2016



Most switches supplied with Classic Update and Universal Kits ship with the shaft pre-installed. In many instances, the switch can be installed without removing the shaft, but in some cases the switch shaft may need to be trimmed to fit your specific dash. In this situation, reference Trim to Fit instructions on the back of this page for details.

### To install your new headlight switch:

1. Install the switch from behind the dash, and align the switch body with the mounting hole. The switch body has an alignment tab that must line up with the notch in the dashboard mounting hole.

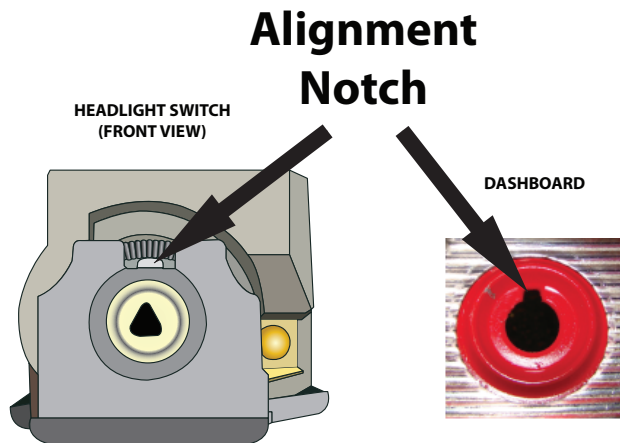







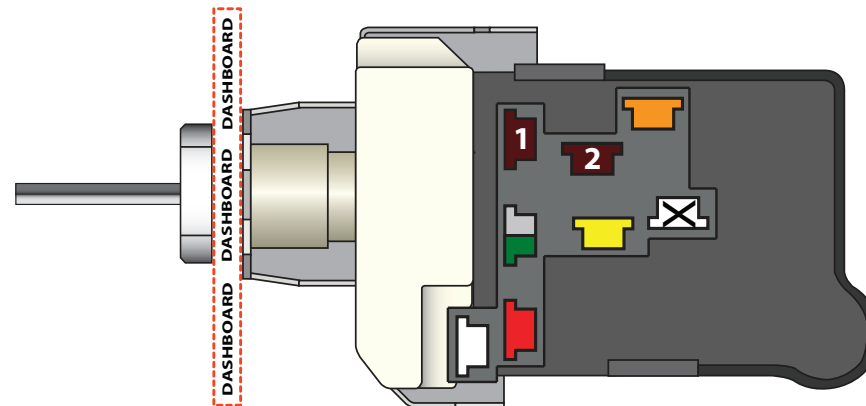

2. Install the switch mounting nut and tighten.

3. Gently press shaft into switch until it stops, then press firmly until it “clicks.” Pull shaft back out to confirm it is seated correctly. The shaft should be locked into place inside switch.

4. If the shaft does not lock, reinsert applying moderate pressure and slowly move shaft side to side for lock to engage. Make sure switch body is still supported to prevent flexing. Press shaft firmly until it clicks into place.

5. Ensure the shaft is fully seated and in the off position.



<b>1</b>	Parking Lights - Stay on with headlights
<b>2</b>	Tail Lights - On in the park and headlight positions
	Fused Battery Feed - For park, tail and dash lamps
	Headlight Feed - Power to the headlight dimmer switch
	12V Battery Feed - Unfused power to the switch for headlights
	Courtesy Ground - Ground feed to the dome and courtesy lights
	Part-Time Parking Lights - Turns off when the headlights are on (Not supported by all kits)
	OR
	



www.americanautowire.com 856-933-0801

PART #

**500332**

DESCRIPTION:

**Headlight Switch**

92964649 Rev 3.0 1/3/2020

## To Trim Shaft to Fit or Remove Shaft:

The headlight shaft knob should extend from the face of the mounting nut, and must allow enough clearance for the switch to turn off. If the shaft is longer than necessary for your specific dash it can be trimmed to fit. Always trim the knob end of the shaft only and follow the guidelines below for best results.

1. With the headlight switch installed, loosen the set screw and remove the knob. Make sure the switch is in the "off" position by pushing the shaft toward the back of the switch.

**Switch in OFF position**  
(shaft pushed all the way in)

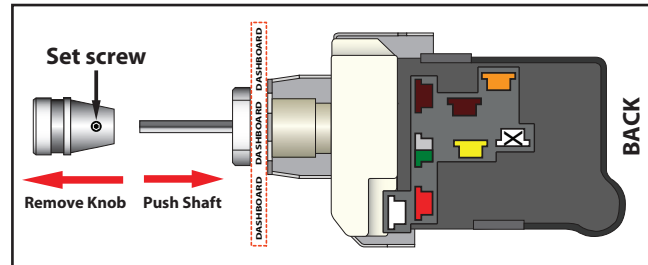

2. Set knob alongside shaft and mark the desired location for cutting on the shaft.

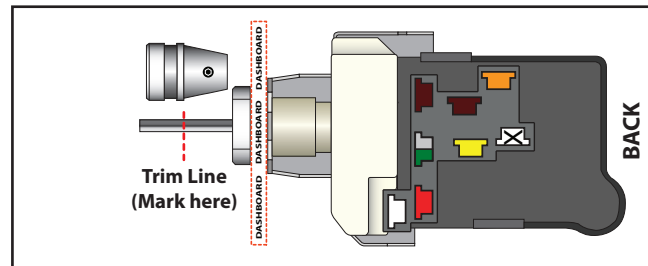

3. Remove the shaft and trim at mark. The shaft can be released from the switch by pulling it outward (toward the rear of the vehicle). Once fully in the "On" position, press and hold the release button on the base of the switch body. Once button is pressed, continue to pull the shaft outward. New switches may be tight, and it might be necessary to move the shaft side to side slightly while pulling to release.

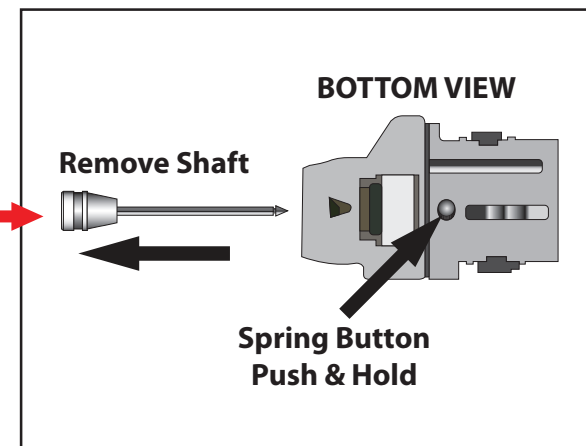
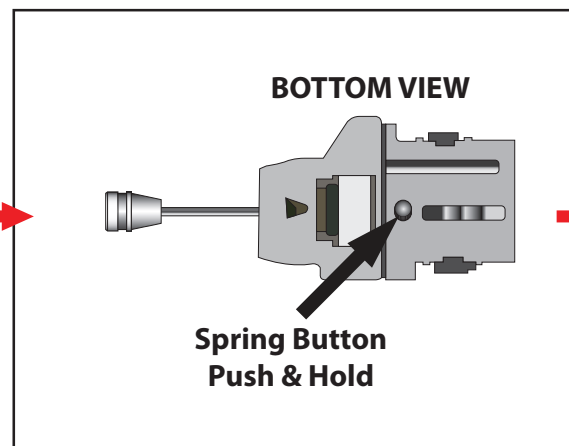
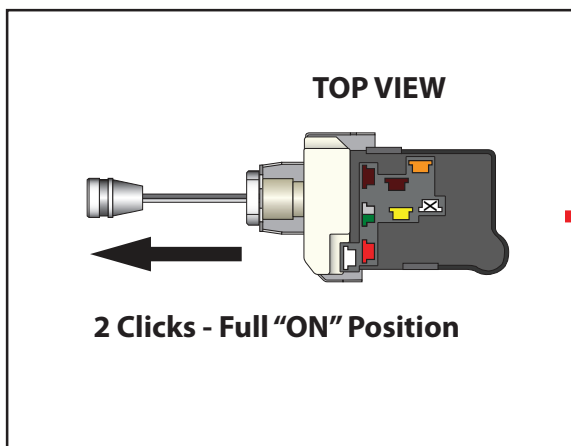

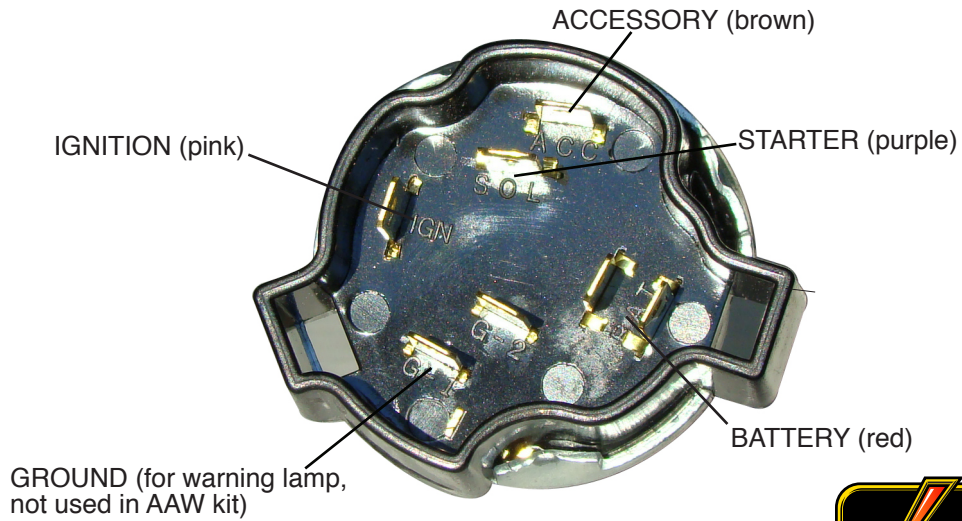

**American  
Autowire**

856-933-0801

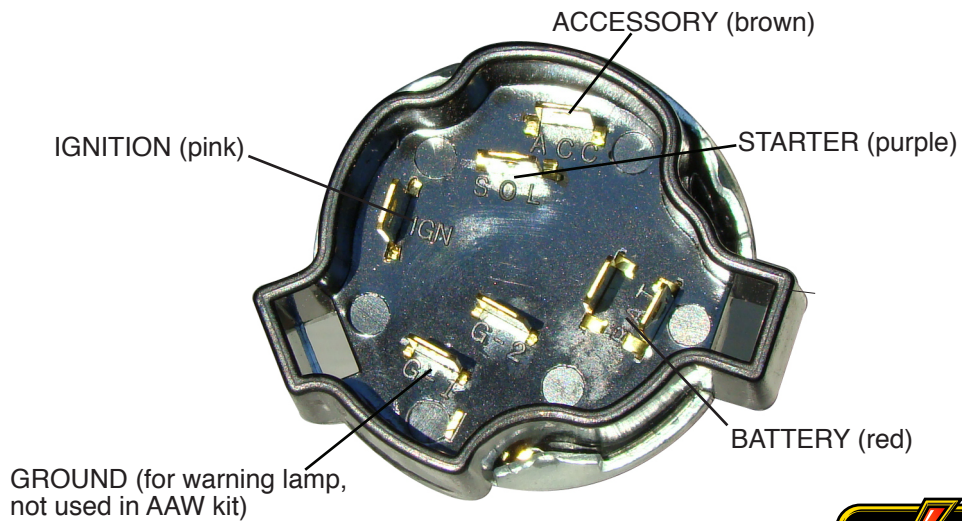

**American  
Autowire**

856-933-0801

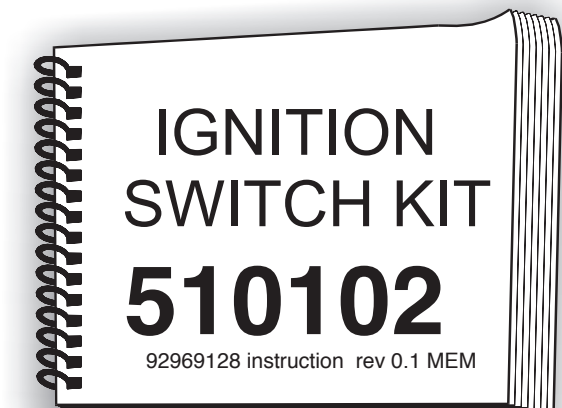

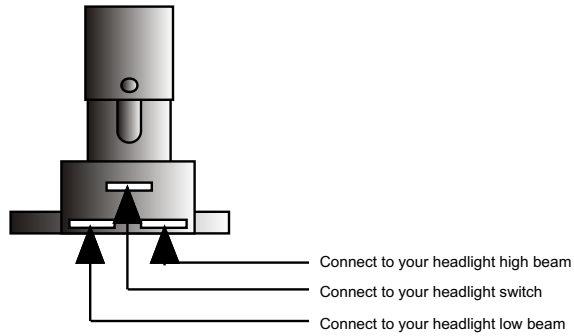

Connect the Dimmer Switch wires as shown above.

1. The top center terminal of the Dimmer Switch is connected to the Headlight switch.
2. The terminal on the right side is connected to your headlight high beam terminal.
3. The terminal on the left side is connected to your headlight low beam terminal.

another wiring product by...



150 Heller Pl #17 W Bellmawr, NJ 08031 856-933-0801

PART #

**500042**

DESCRIPTION:

**DIMMER SWITCH**

92964573 instruction sheet Rev 3.0 6/29/99

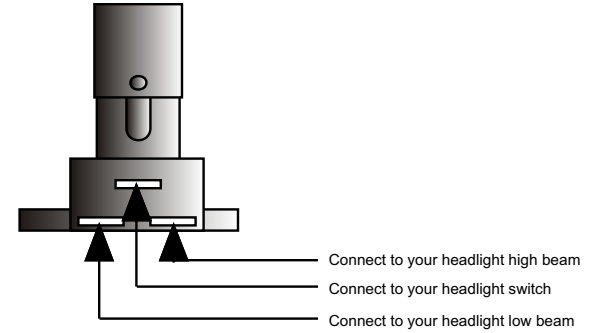

Connect the Dimmer Switch wires as shown above.

1. The top center terminal of the Dimmer Switch is connected to the Headlight switch.
2. The terminal on the right side is connected to your headlight high beam terminal.
3. The terminal on the left side is connected to your headlight low beam terminal.

another wiring product by...



150 Heller Pl #17 W Bellmawr, NJ 08031 856-933-0801

PART #

**500042**

DESCRIPTION:

**DIMMER SWITCH**

92964573 instruction sheet Rev 3.0 6/29/99