

NOTE: If the fuse panel on your 510201 1968 Nova kit **HAS** a sticker like the photo at the left, you have the second design harness and your instructions are listed below and follow this page.

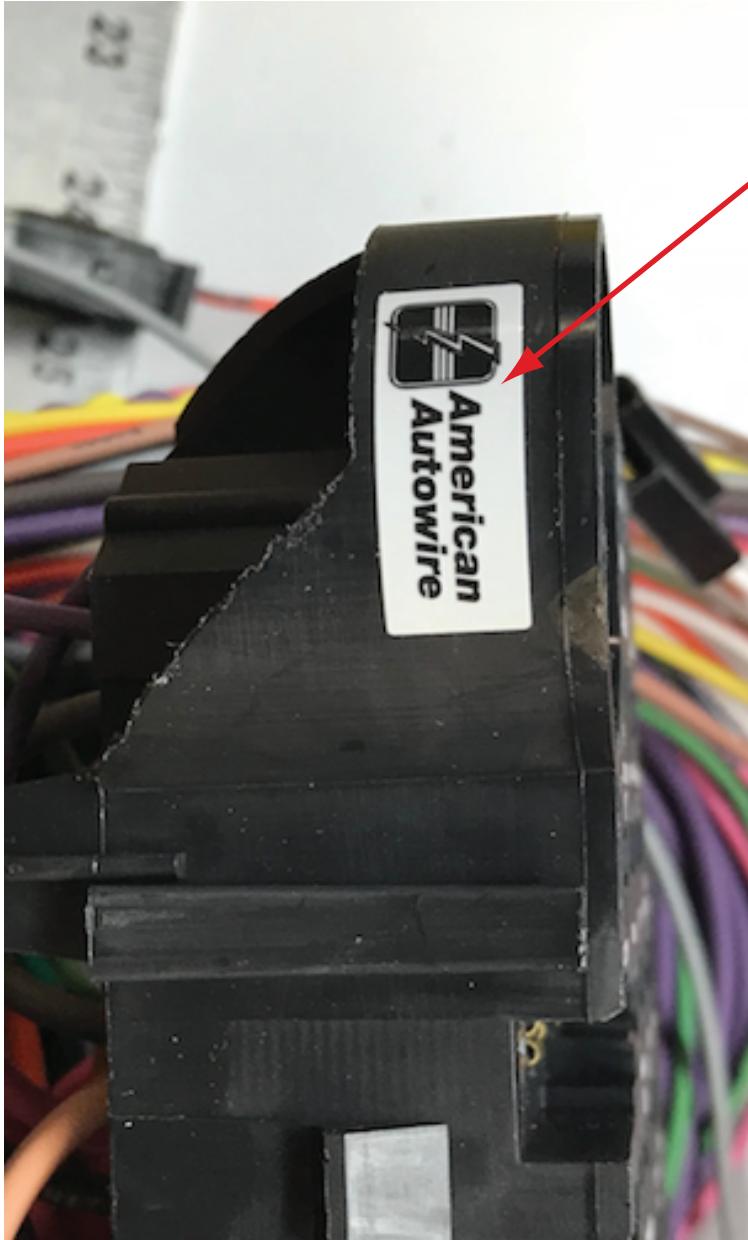

Number	Description
500332	Headlight Switch
500707	Fuse, Relay, and Flasher kit
500708	Courtesy Light kit
500919	Practice Terminal Crimping Set
510512	Dash Harness kit
510510	Engine Wiring Kit
510511	Front Light Wiring kit
510509	Instrument Cluster Wiring kit
500664	Console Gauge Wiring kit
500673	Rear Body Wiring kit
510476	Alternator and main power Connection kit
510730	VSS Connection kit
510227	Dash Jumper Harnesses
500042	Floor Dimmer Switch
92972485	Kit Introduction Instruction Sheet
92972503	Kit Supplemental Instruction Sheet
92972487	Warning Sheet



www.americanautowire.com 856-933-0801

1968 Nova
Second Design
Instructions

92972878 rev. 0.0 1/27/2020



WARNING:

Validate the kit contents with the component list included on page 2 of this sheet before proceeding. This kit is intended to be used in a modified vehicle. Please read this sheet thoroughly and be sure that you understand everything explained on it prior to opening any of the enclosed packages, or before attempting to install any of the components. Once this kit has been opened or a component installed, the kit is not returnable.

1. This kit should typically be used in a **MODIFIED** application only.
2. This kit supports the use of factory heater systems and aftermarket heater and A/C systems. The kit supplies power to a factory A/C control head but **DOES NOT** include the actual A/C harness for an original factory A/C vehicle. Factory original A/C harnesses are available under our Factory Fit product line as they are self contained harnesses made to fit and work with the stock A/C component configuration.
3. This kit supports the use of a high current self-exciting 1-wire alternator or other style internally regulated alternators. An adapter may be necessary in some applications. The use of a stock, low amperage alternator is seriously discouraged as they cannot handle the higher current requirements of updated ignition systems, electric fans, aftermarket A/C systems, stereo systems, air ride suspensions, and other power hungry accessories and will ultimately create performance issues with the system.
4. This kit **WILL NOT** support the use of a factory ammeter. All AAW kits are engineered to supply the optimum charge to the battery. To achieve this performance, we route our 6ga. charge wire directly from the alternator output charge terminal to the starter battery terminal. Due to the path of the charge being altered from the stock configuration, the gauge can no longer see a charge vs. a discharge, so it will not work properly. When ammeters were originally used, most generator or alternator current outputs were rated at a maximum of about 25-60 amps. Modified cars being built today typically utilize a 100 amp or higher output alternator. With these higher current units, ammeters, generally speaking, become a safety hazard. Ammeters are usually wired in parallel to the charging circuit, are typically unfused, and can short very easily causing a fire. A voltmeter is recommended as a good alternative.
5. This kit **IS NOT** set up with a resistance wire for a standard, points type ignition system. It is wired with a full 12 volt primary ignition feed that is hot in the run position. Primary ignition voltage in the starting position is handled via a full 12 volt bypass wire. Our system will support HEI, MSD, other electronic ignition systems, as well as most all computerized Fuel Injection systems. If you wish to run a points type system, there are illustrations on the engine connection pages to do so. Extra parts (ballist resistor) that are not included in this kit will be required to complete that operation.



**American
Autowire**

510201

510201 - Classic Update Series Kit 1968 Chevrolet Nova

This kit contains the following components:

<u>Bag</u>	<u>Part Number</u>	<u>Description</u>	<u>Quantity</u>
	500042	Floor Dimmer Switch	1
	500332	Headlight Switch	1
H	510509	Instrument Cluster wiring kit	1
K	500664	Console Gauge Wiring kit	1
J	510510	Engine Wiring Kit	1
L	510511	Front Light Wiring kit	1
M	500673	Rear Body Wiring kit	1
	500707	Fuse, Relay, and Flasher kit	1
N	500708	Courtesy Light kit	1
G	510512	Dash Harness kit	1
	500919	Practice Terminal Crimping Set	1
V	510730	VSS Connection Kit	1
Z	510476	Alternator and Main Power Connection Kit	1
	510227	Dash Jumper Harnesses	1
	92972485	Kit Introduction Instruction Sheet	1
	92972503	Kit Supplemental Instruction Sheet	1
	92972487	Warning Sheet	1

Validate the kit contents with this component list. If there are any discrepancies with incorrect or missing parts, stop your installation and notify the supplier you purchased the kit from before proceeding.



www.americanautowire.com 856-933-0801

510201

92972487 instruction sheet Rev 0.0 8/29/2019

Classic Update Series

1969-72 Nova

START HERE !

PLEASE READ THIS BEFORE STARTING INSTALLATION !

This wiring kit is designed for ease of installation. Please read the guidelines below, BEFORE STARTING your installation to guarantee a successful job!! Use an appropriate crimping tool which folds the crimp wings on the terminals as shown below. Top quality crimping tools are available from American Autowire or American Autowire authorized dealers.

NOTE: ALL TERMINALS THAT YOU INSTALL SHOULD BE PROPERLY SOLDERED.

Our factory terminations are installed by GM approved termination presses, and soldering is not necessary on these terminations.

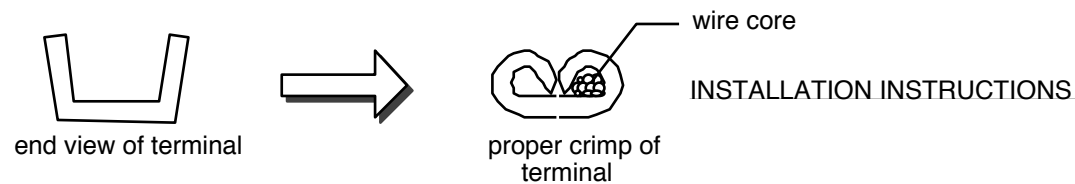

STEP 1: DISCONNECT YOUR BATTERY:

Disconnect the battery before installing the wiring kit to prevent any accidental shorting caused by loose bare wire ends.

STEP 2: START INSTALLING KIT: This kit is broken down into individual steps that are identified by a letter printed on the instruction sheets visible through each bag. These letters are the order of operation for installing your kit. Start with the bag letter "G", then "H", etc. The order of installation is shown below:

G 510512	Dash Harness Kit
H 510509	Instrument Cluster Kit
J 510510	Engine Kit
K 500664	Console Kit
L 510511	Front Light Kit
M 500673	Rear Body Kit
N 500708	Courtesy Light Kit
V 510730	VSS Connection Kit
Z 510476	Alternator and Main Power Kit

STEP 3: RECONNECT YOUR BATTERY:

When you have completed the installation and are ready to reconnect the battery, make sure that the following electrical system grounds are in place:

- A. Battery is grounded to the ENGINE BLOCK.
- B. Battery is grounded to the frame.
- C. Engine block is grounded to the frame.
- D. Body is grounded to the frame.

STEP 4: CHECK ALL ELECTRICAL FUNCTIONS:

Any non-functioning items should be checked for proper installation. Any problems with your wiring and electrical circuit functions should be addressed to American Autowire Systems, Inc. as soon as possible to avoid any warranty problems.

If you have any questions concerning this or any of our products, please feel free to call us at 1-800-482-WIRE.

We carry many accessories for your 1969 Camaro

p/n R0067108
OEM style non-stick harness tape



p/n CA82006 (1969-72)
Factory console gauge terminal kit.

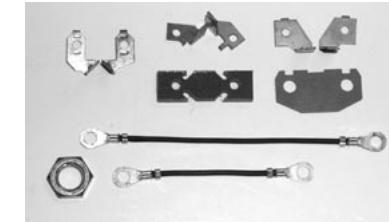

p/n 01993464 (1969-71)
p/n 01994180 (1972)
OEM style wiper switch.

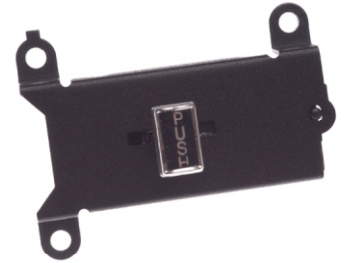

p/n 03943657 (1969-72)
Muncie 4 speed back up lamp switch.



p/n 510586
OEM large terminal and double crimping tool (20-8 gauge).



p/n 510585
Multi-crimp tool (20-14 gauge).



p/n 38131
Breakerless Ignition Module,
GM V-8 POINT CONVERSION KIT



p/n 36310 (1969)
p/n 36311 (1970)
p/n 36312 (1971)
p/n 36313 (1972)

Factory assembly manual.
(It's what they used on the assembly line to build your Nova!)

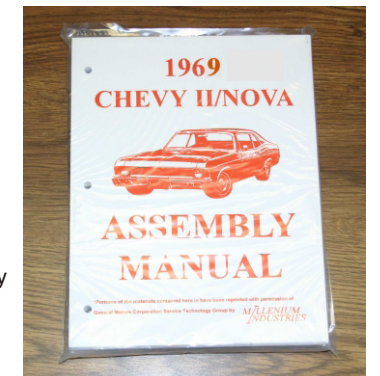

www.americanautowire.com 856-933-0801

Classic Update Series

1969-72 Nova

500878

© COPYRIGHT 2004 American Autowire / Factory-Fit
Used with express permission of
American Autowire / Factory-Fit
92972485 instruction sheet rev. 0.0 8/1/2019

Classic Update Series

1969-72 Nova



www.americanautowire.com 856-933-0801

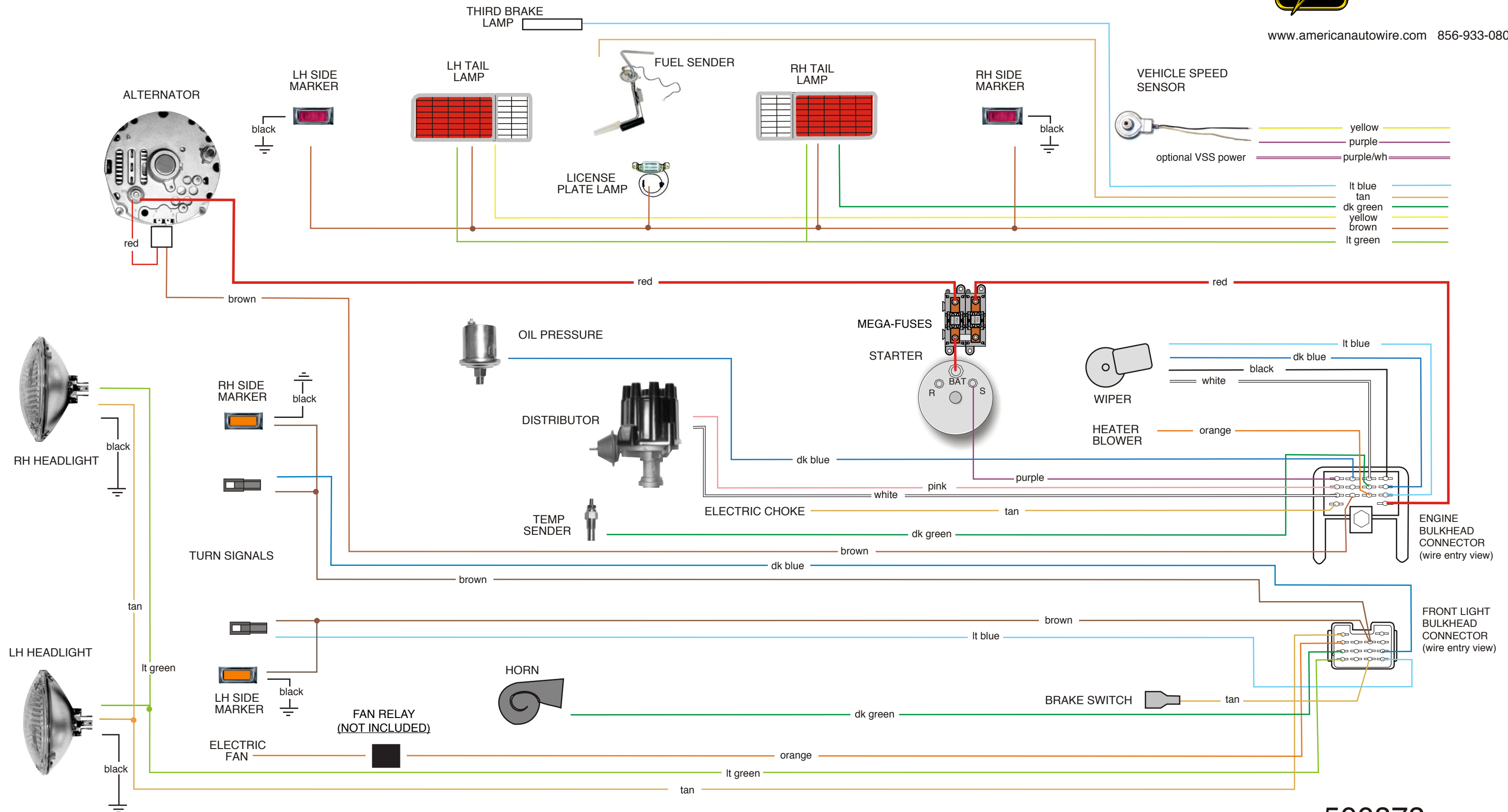

NOTICE: This schematic drawing is for reference only. Do not use the schematic to install this wiring kit! Use the instruction sheets included in each bag, which includes directions for proper terminations, and specific applications (such as Rally Sport).

500878

© COPYRIGHT 2004 American Autowire / Factory-Fit
Used with express permission of American Autowire / Factory-Fit
92972485 instruction sheet rev. 0.0 8/1/2019



www.americanautowire.com 856-933-0801

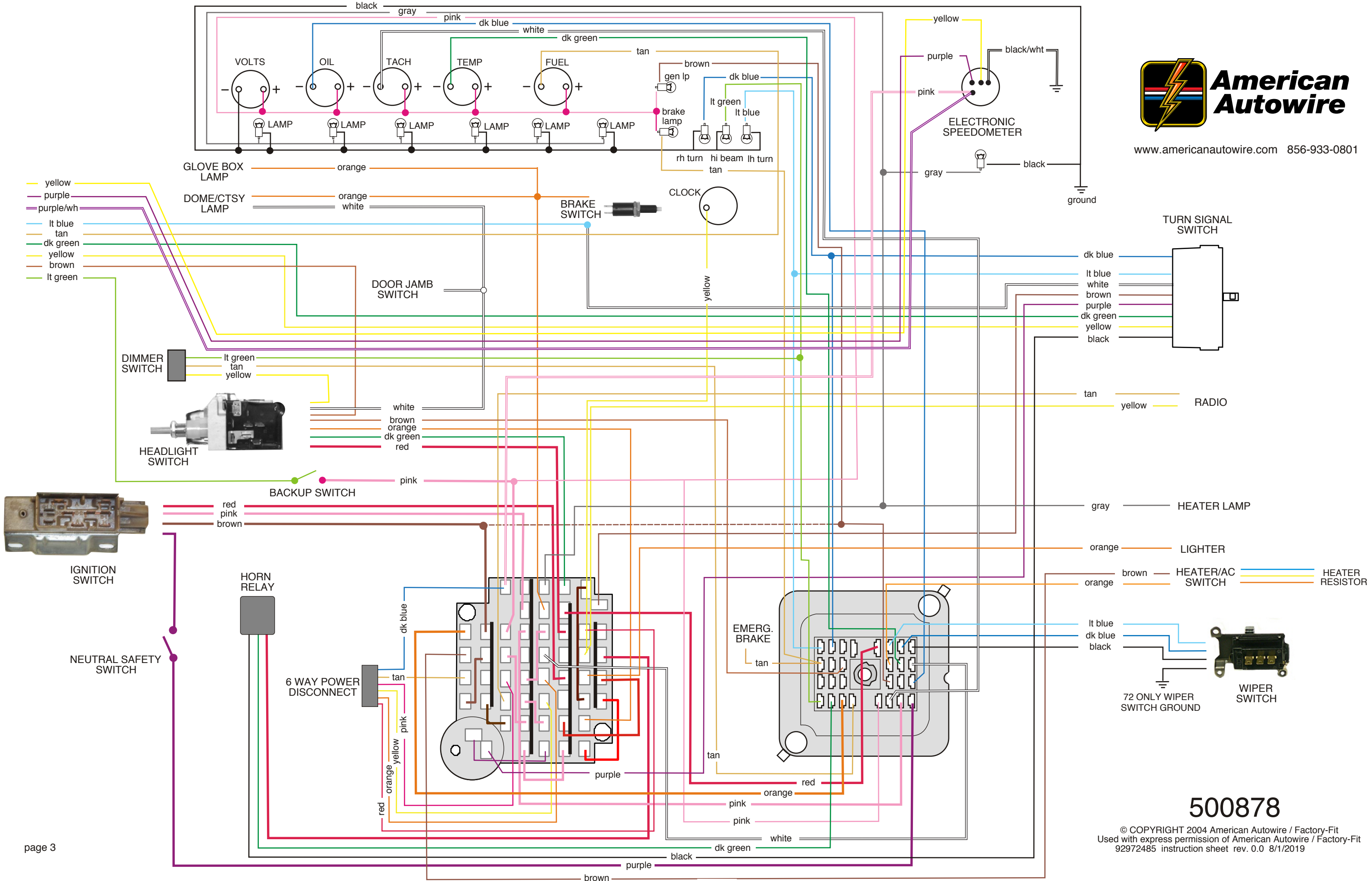

- yellow
- purple
- purple/wh
- lt blue
- tan
- dk green
- yellow
- brown
- lt green

- GLOVE BOX LAMP — orange
- DOME/CTSY LAMP — orange white
- BRAKE SWITCH — yellow
- DOOR JAMB SWITCH — white
- HEADLIGHT SWITCH — lt green, tan, yellow
- BACKUP SWITCH — pink

- white
- brown
- orange
- dk green
- red

- dk blue
- lt blue
- white
- brown
- purple
- dk green
- yellow
- black

- tan
- yellow

- gray — HEATER LAMP
- orange — LIGHTER
- brown — HEATER/AC SWITCH
- orange — HEATER RESISTOR

- lt blue
- dk blue
- black

500878

© COPYRIGHT 2004 American Autowire / Factory-Fit
Used with express permission of American Autowire / Factory-Fit
92972485 instruction sheet rev. 0.0 8/1/2019

THIS PAGE HAS BEEN INTENTIONALLY LEFT BLANK



On the next 4 pages, you will find several detailed specialized instructions that will help you install our '69-'72 Nova Classic Update Dash Kit, P/N 510512, into your 1968 Nova. These instructions along with the specialized harnesses and parts from this wire kit will need to be used in conjunction with the corresponding instructions and many parts, from the 510512 dash kit. These dash modifications include the following specialized jumper harnesses:

1. ignition switch extension
2. heater switch extension
3. wiper switch extension

The entire balance of the 1969-1972 Nova kit will install into any 1968 car without any further modifications or issues.



**American
Autowire**

www.americanautowire.com 856-933-0801

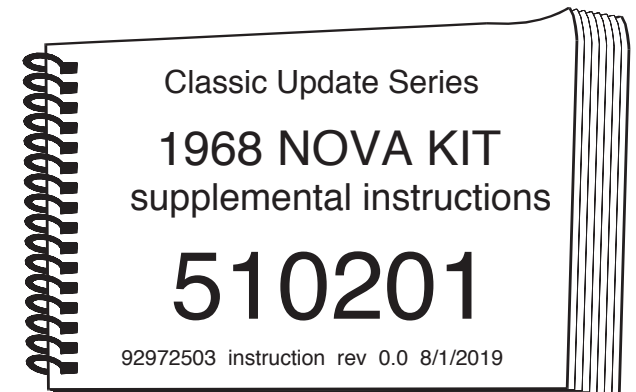

Classic Update Series

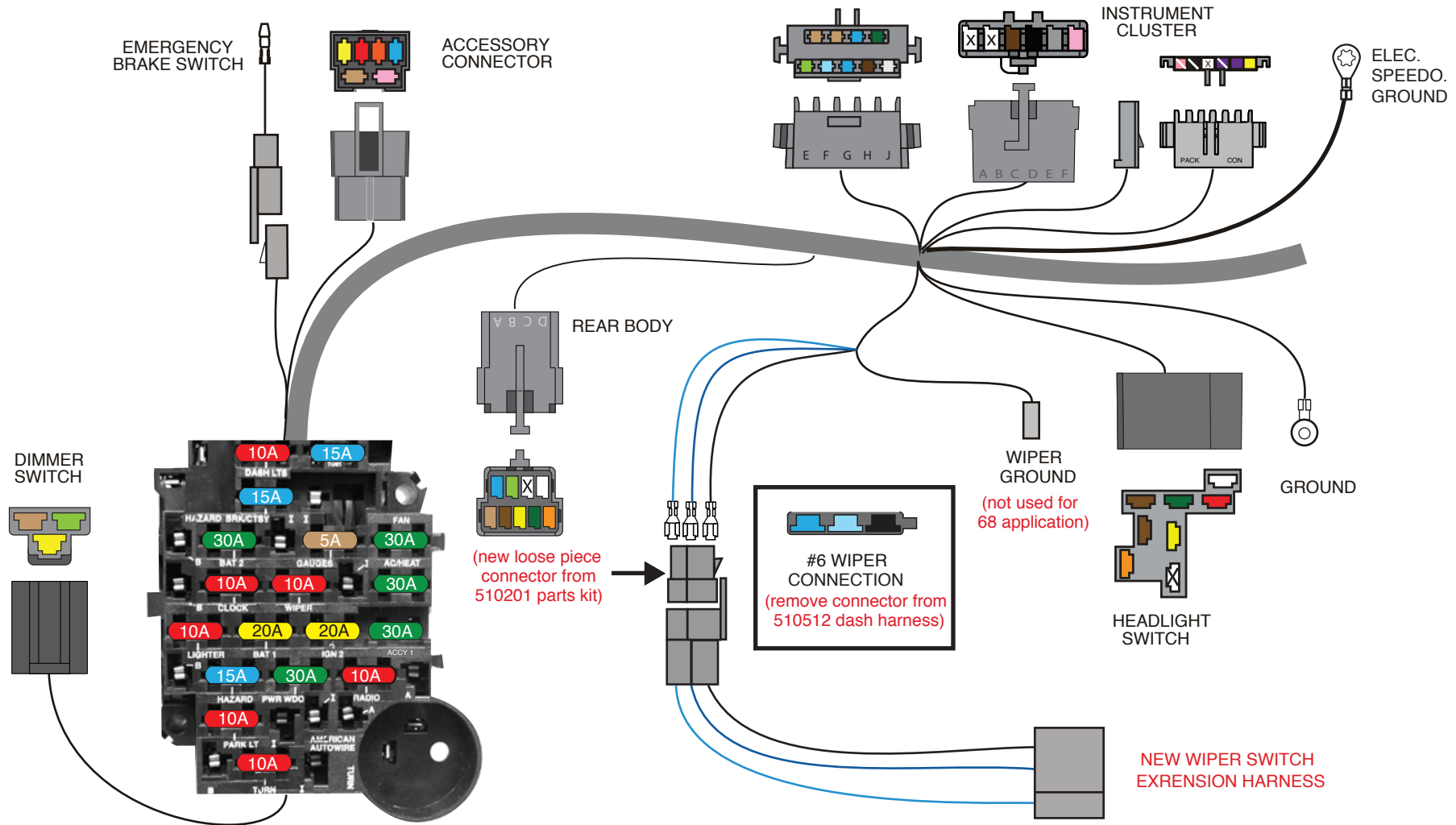

1. Remove the wiper switch connector from location number 6 on the '69-'72 dash harness, 510512, bag G as shown above by simply inserting a small screwdriver or thin pick into the face of the connector and releasing the locking tabs on the 3 terminals (be sure to lift those locking tabs back up once the terminals have been removed so they will lock into the new connector in step 2).

2. Install the lt. blue, dk. blue, and black wires from the wiper switch connection of the dash harness, 510512, into the new loose piece 3-position connector from kit 510201. Be sure to maintain color continuity with the New Wiper Switch Extension Harness. If for some reason you damage the wiper terminals of the original dash harness, new ones have been provided for you in this kit. Simply cut off the old terminals and crimp the new ones on prior to plugging in the new connector.

3. Plug the New Wiper Switch Extension Harness onto the modified dash harness connection from step 2 above, then plug this new connection onto your 1968 wiper switch to complete the wiper circuit of your 68 Nova.



Wiper
Switch Extension
1968 Nova

510201

Classic Update Series

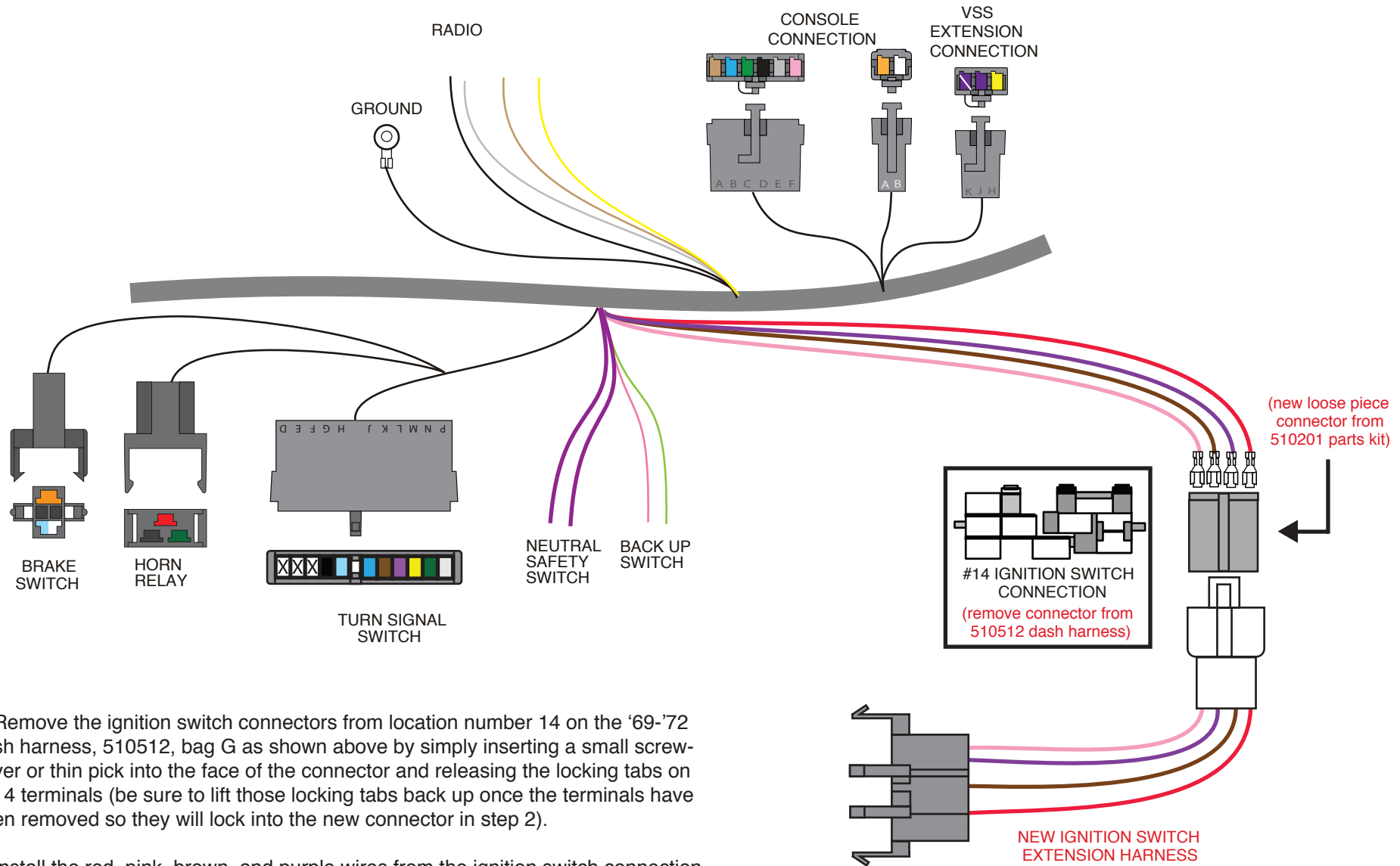

1. Remove the ignition switch connectors from location number 14 on the '69-'72 dash harness, 510512, bag G as shown above by simply inserting a small screwdriver or thin pick into the face of the connector and releasing the locking tabs on the 4 terminals (be sure to lift those locking tabs back up once the terminals have been removed so they will lock into the new connector in step 2).

2. Install the red, pink, brown, and purple wires from the ignition switch connection of the dash harness, 510512, into one of the new loose piece 4-position connectors from kit 510201. Be sure to maintain color continuity with the New Ignition Switch Extension Harness. If for some reason you damage the ignition terminals of the original dash harness, new ones have been provided for you in this kit. Simply cut off the old terminals and crimp the new ones on prior to plugging in the new connector.

3. Plug the New Ignition Switch Extension Harness onto the modified dash harness connection from step 2 above, then plug this new connection onto your original 1968 ignition switch (switch not included) to complete the ignition switch circuit of your 68 Nova.



Ignition
Switch Extension
1968 Nova
510201

Classic Update Series

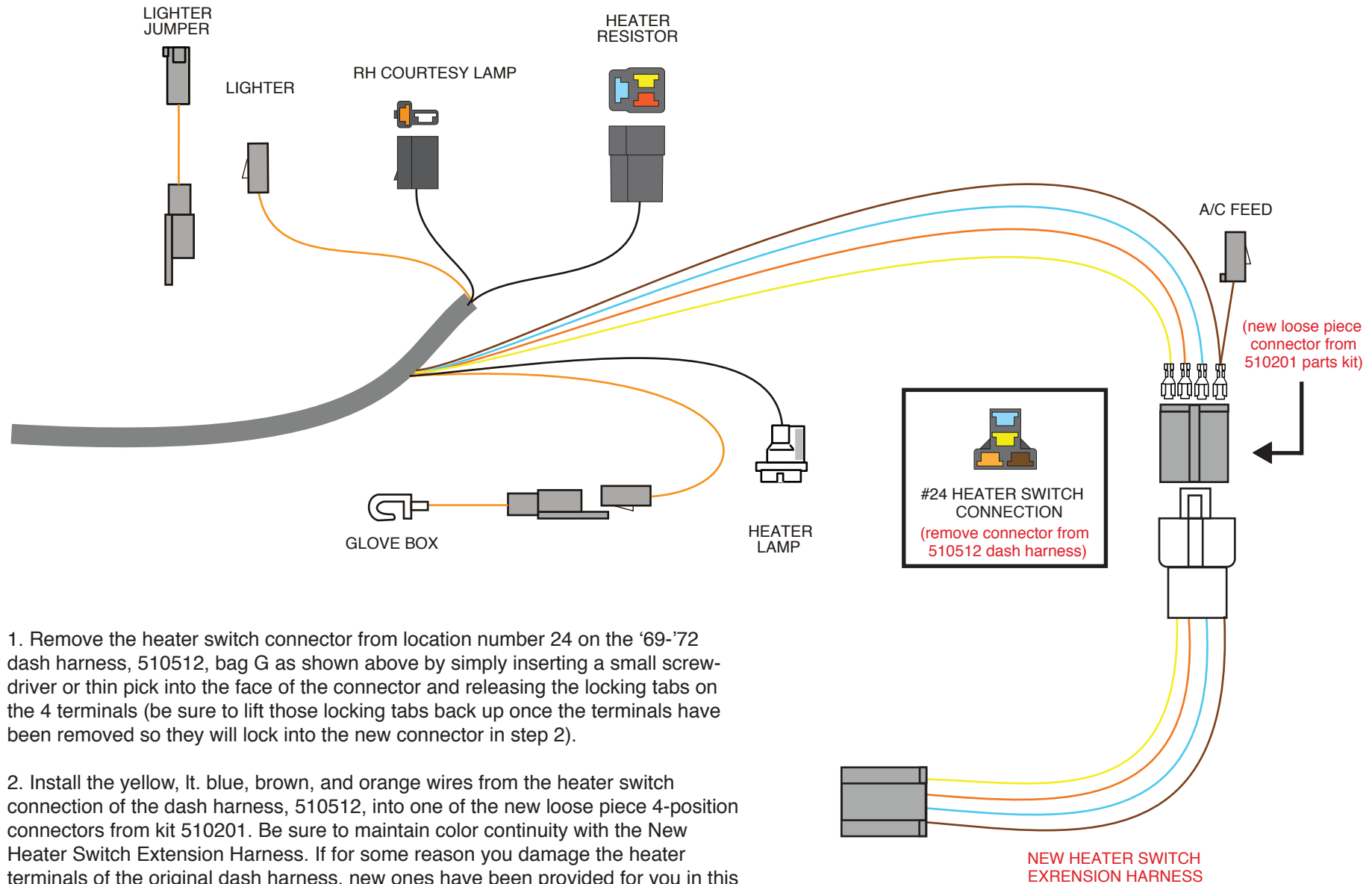

1. Remove the heater switch connector from location number 24 on the '69-'72 dash harness, 510512, bag G as shown above by simply inserting a small screwdriver or thin pick into the face of the connector and releasing the locking tabs on the 4 terminals (be sure to lift those locking tabs back up once the terminals have been removed so they will lock into the new connector in step 2).

2. Install the yellow, lt. blue, brown, and orange wires from the heater switch connection of the dash harness, 510512, into one of the new loose piece 4-position connectors from kit 510201. Be sure to maintain color continuity with the New Heater Switch Extension Harness. If for some reason you damage the heater terminals of the original dash harness, new ones have been provided for you in this kit. Simply cut off the old terminals and crimp the new ones on prior to plugging in the new connector.

3. Plug the New Heater Switch Extension Harness onto the modified dash harness connection from step 2 above, then plug this new connection onto your original 1968 heater switch to complete the heater switch circuit of your 68 Nova.



Heater
Switch Extension
1968 Nova

510201

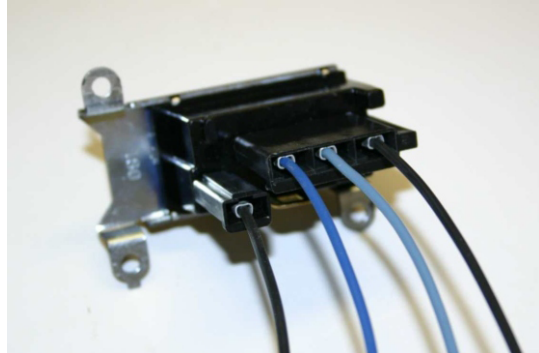
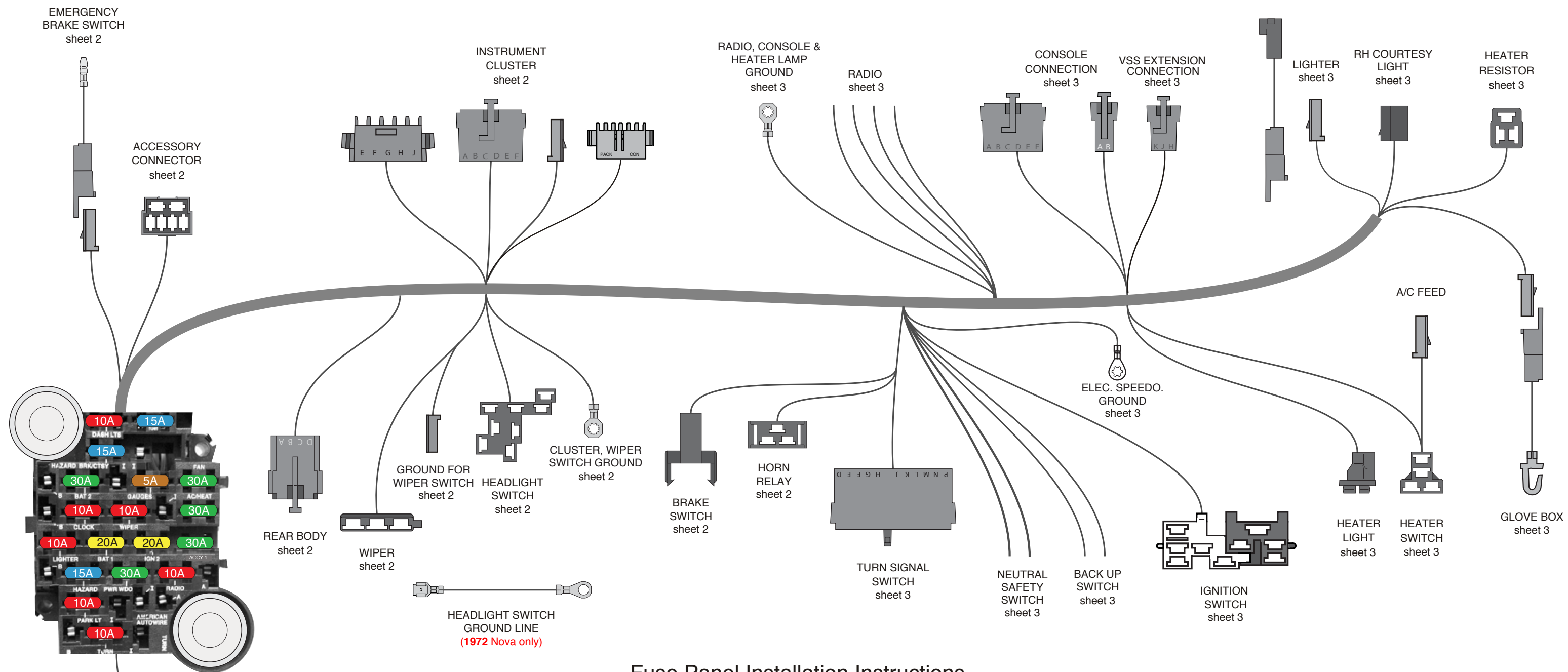

The above picture shows the orientation for **1972** Nova wiper hook-up **only**. All other applications can only be plugged in one way.

Fuse Panel Installation Instructions

Following these simple instructions will guarantee a successful installation of your American Autowire fuse panel harness.

1. Study the diagram above to familiarize yourself with the dash harness.
2. Install the fuse box.
3. Route the dash harness using the factory support straps.
4. Make all connections as shown on the following pages of this dash harness kit.
5. Once this harness is installed, continue to bag 'H', and install the rest of the kit (bags H,J,K,L,M).



www.americanautowire.com 856-933-0801



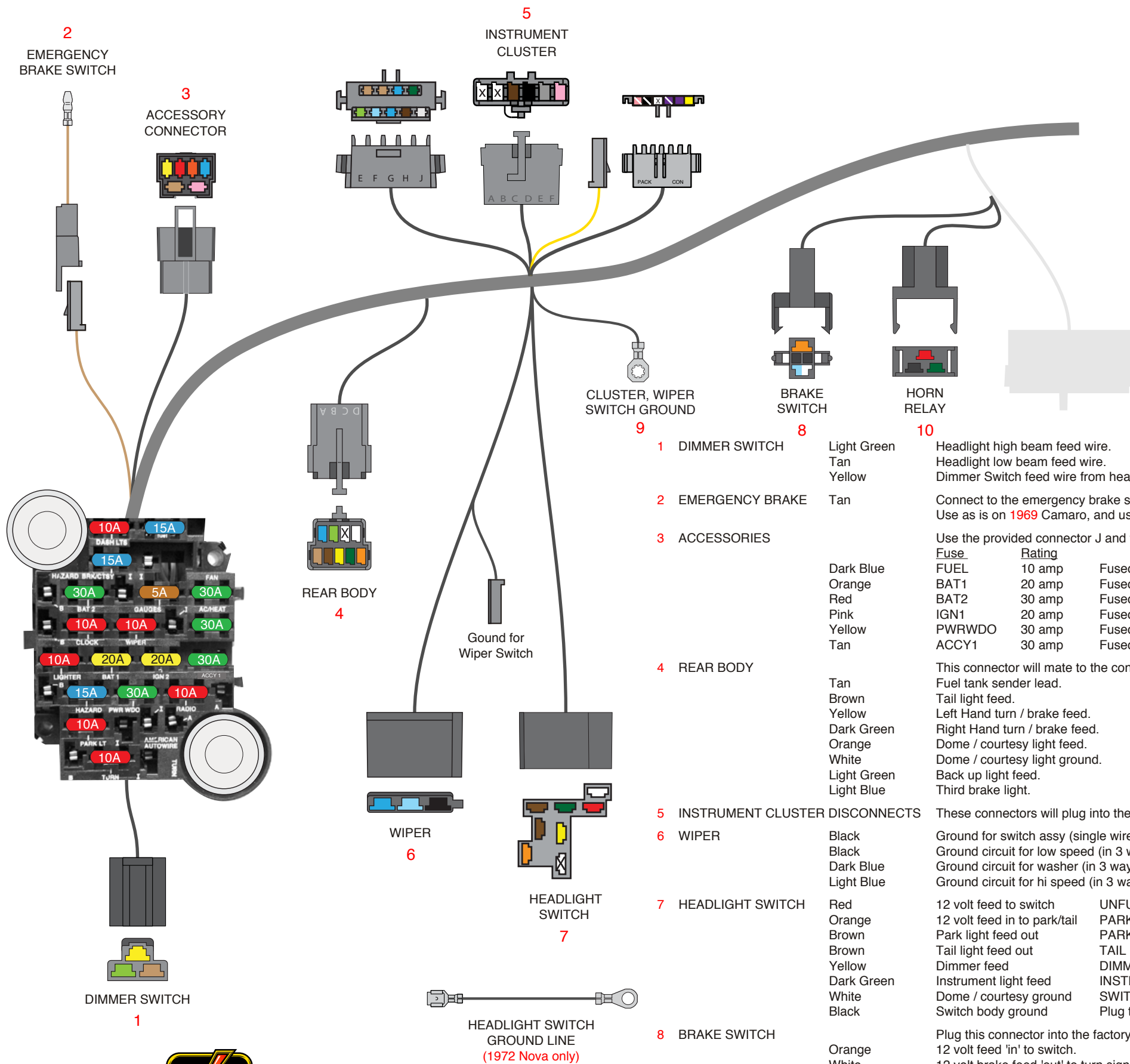

INSTALLING THE FUSE BOX

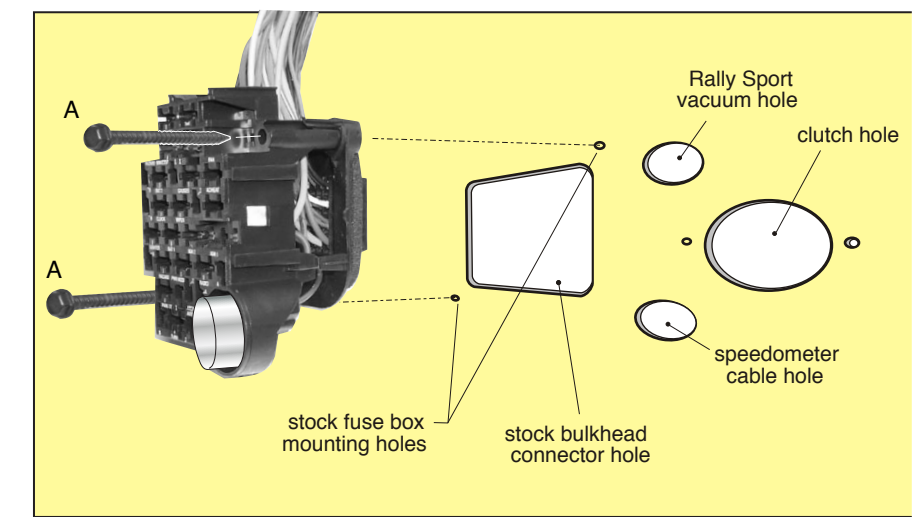

1. Locate the stock OEM bulkhead hole in the driver side of the firewall.
2. Mount the fuse box with the flasher can in the bottom right corner, as shown above.
3. Using the two mounting screws A, attach the fuse panel to the firewall.

1	DIMMER SWITCH	Light Green Tan Yellow	Headlight high beam feed wire. Headlight low beam feed wire. Dimmer Switch feed wire from headlight switch.																					
2	EMERGENCY BRAKE	Tan	Connect to the emergency brake switch. This is the ground circuit for the brake switch light. Use as is on 1969 Camaro, and use female connector on Nova applications.																					
3	ACCESSORIES		Use the provided connector J and terminals as power leads for the following: <table border="1"> <thead> <tr> <th>Fuse</th> <th>Rating</th> <th>Description</th> </tr> </thead> <tbody> <tr> <td>FUEL</td> <td>10 amp</td> <td>Fused 12 volt IGNITION feed for fuel pump (may also be used to feed power to another ignition circuit).</td> </tr> <tr> <td>BAT1</td> <td>20 amp</td> <td>Fused 12 volt BATTERY feed for power seats (may also be used to feed power to another battery circuit).</td> </tr> <tr> <td>BAT2</td> <td>30 amp</td> <td>Fused 12 volt BATTERY feed for power door locks (may also be used to feed power to another accessory circuit).</td> </tr> <tr> <td>IGN1</td> <td>20 amp</td> <td>Fused 12 volt IGNITION feed for cruise control (may also be used to feed power to another ignition circuit).</td> </tr> <tr> <td>PWRWDO</td> <td>30 amp</td> <td>Fused 12 volt IGNITION feed for power windows (may also be used to feed power to another ignition circuit).</td> </tr> <tr> <td>ACCY1</td> <td>30 amp</td> <td>Fused 12 volt ACCESSORY feed (may also be used to feed power to an accessory circuit).</td> </tr> </tbody> </table>	Fuse	Rating	Description	FUEL	10 amp	Fused 12 volt IGNITION feed for fuel pump (may also be used to feed power to another ignition circuit).	BAT1	20 amp	Fused 12 volt BATTERY feed for power seats (may also be used to feed power to another battery circuit).	BAT2	30 amp	Fused 12 volt BATTERY feed for power door locks (may also be used to feed power to another accessory circuit).	IGN1	20 amp	Fused 12 volt IGNITION feed for cruise control (may also be used to feed power to another ignition circuit).	PWRWDO	30 amp	Fused 12 volt IGNITION feed for power windows (may also be used to feed power to another ignition circuit).	ACCY1	30 amp	Fused 12 volt ACCESSORY feed (may also be used to feed power to an accessory circuit).
Fuse	Rating	Description																						
FUEL	10 amp	Fused 12 volt IGNITION feed for fuel pump (may also be used to feed power to another ignition circuit).																						
BAT1	20 amp	Fused 12 volt BATTERY feed for power seats (may also be used to feed power to another battery circuit).																						
BAT2	30 amp	Fused 12 volt BATTERY feed for power door locks (may also be used to feed power to another accessory circuit).																						
IGN1	20 amp	Fused 12 volt IGNITION feed for cruise control (may also be used to feed power to another ignition circuit).																						
PWRWDO	30 amp	Fused 12 volt IGNITION feed for power windows (may also be used to feed power to another ignition circuit).																						
ACCY1	30 amp	Fused 12 volt ACCESSORY feed (may also be used to feed power to an accessory circuit).																						
4	REAR BODY	Tan Brown Yellow Dark Green Orange White Light Green Light Blue	This connector will mate to the connector from the Rear Body harness found in bag L. Fuel tank sender lead. Tail light feed. Left Hand turn / brake feed. Right Hand turn / brake feed. Dome / courtesy light feed. Dome / courtesy light ground. Back up light feed. Third brake light.																					
5	INSTRUMENT CLUSTER DISCONNECTS		These connectors will plug into the gauge disconnect harness from bag H. Wire identifications are described on the Instruction sheets from bag H.																					
6	WIPER	Black Black Dark Blue Light Blue	Ground for switch assy (single wire used in 1972 Nova only) Ground circuit for low speed (in 3 way connector). Ground circuit for washer (in 3 way connector). Ground circuit for hi speed (in 3 way connector).																					
7	HEADLIGHT SWITCH	Red Orange Brown Brown Yellow Dark Green White Black	12 volt feed to switch 12 volt feed in to park/tail Park light feed out Tail light feed out Dimmer feed Instrument light feed Dome / courtesy ground Switch body ground UNFUSED BAT IN location on headlight switch. PARK/TAIL FEED IN location on headlight switch. PARK LIGHT OUT location on headlight switch. TAIL LIGHT OUT location on headlight switch. DIMMER FEED OUT location on headlight switch. INSTRUMENT LIGHT FEED OUT location on headlight switch. SWITCHED COURTESY GROUND location on headlight switch. Plug this onto male blade on side of H/L switch then ground ring terminal (for use on 1972 Nova applications only).																					
8	BRAKE SWITCH	Orange White Light Blue	Plug this connector into the factory brake switch. 12 volt feed 'in' to switch. 12 volt brake feed 'out' to turn signal switch. 12 volt brake feed 'out' to third brake light.																					
9	GROUND	Black	Connect to a good chassis ground. This is the ground circuit for the wiper switch and speedo cluster. This must be a unique ground point that is different from the #25 Electric Speedo Ground																					
10	HORN RELAY	Red Black Green	Plug the horn relay (found in the fuse bag) into this connector. 12 volt unfused battery feed to relay. Relay ground circuit (to turn signal switch). Triggered 12 volts out to horn.																					



**American
Autowire**

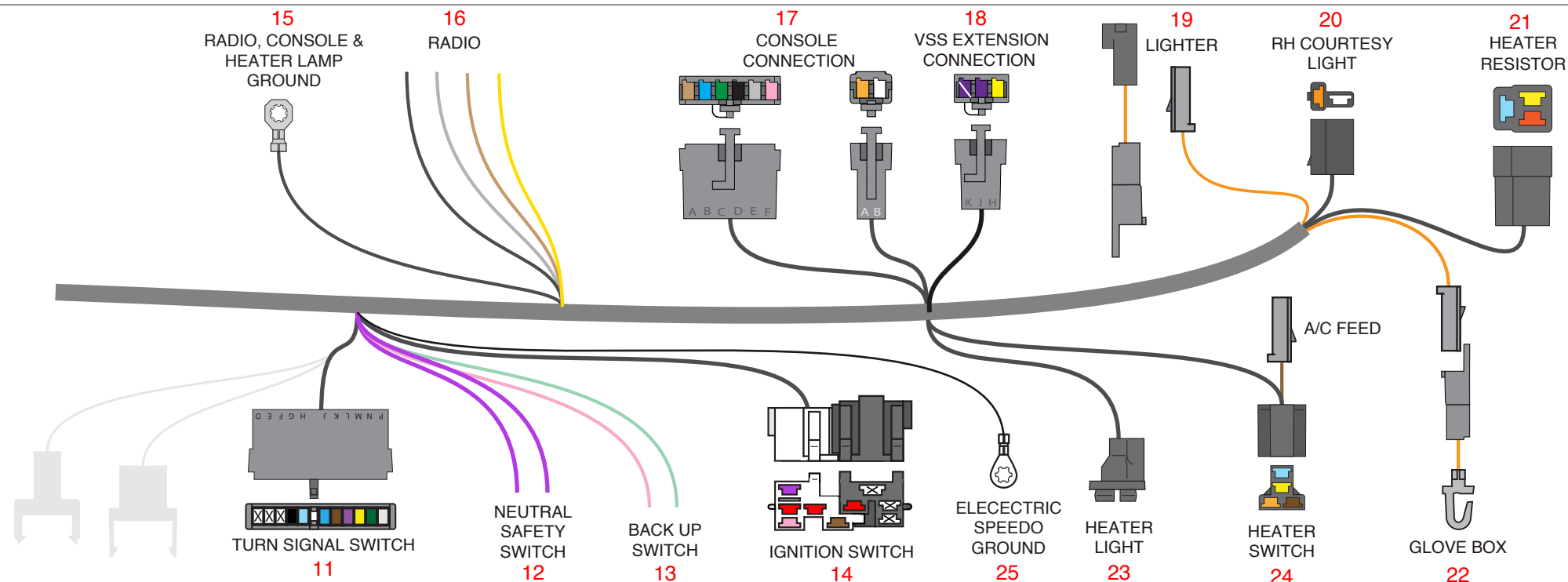

- 11 TURN SIGNAL SWITCH** This harness has a connector on it for the 3-7/8 1969-1974 GM column connection used by GM and many after-market manufacturers. If using a late model GM steering column or an after-market column using the 4-1/4 GM turn signal connector, replace existing connector with connector L, matching wires by color, as shown in Diagram G.
- 12 NEUTRAL SAFETY SWITCH** Connect these wires to the neutral safety switch on the column or console shifter.
 - Purple 12 volt feed 'in' to neutral safety switch from ignition switch.
 - Purple 12 volt feed 'out' to starter solenoid.
- 13 BACK UP SWITCH** Connect these wires to the back up switch on the column or console shifter.
 - Pink 12 volt ignition feed 'in' to back up light switch
 - Lt Green 12 volt feed 'out' from back up light switch to back up lights.
- 14 IGNITION SWITCH** Note: Connectors are included if you are using a stock 1969-72 ignition switch as shown in Diagram H.
 - Red 12 volt battery feed "in".
 - Pink 12 volt ignition feed "out".
 - Brown 12 volt accessory feed "out".
 - Purple Starter lead "out" to Neutral Safety Switch.
- 15 GROUND** Black Connect to a good chassis ground. This is the ground circuit for the radio, console and heater lamp. This must be a unique ground point that is different from the #25 Electric Speedo Ground.
- 16 RADIO**
 - Tan Radio accessory feed. (Power wire for stock radio).
 - Yellow Radio 12 volt clock lead (battery feed) (Loose piece terminals & connectors have been provided for stock radio hook up.)
 - Black Radio ground for stock 1970-72 radio (or aftermarket if necessary).
 - Gray Radio light feed for stock 1970-72 radio (or aftermarket if necessary).
- 17 CONSOLE CONNECTION** These wires are for use on a console vehicle. For wire functions, refer to bag K, 500664.
- 18 VSS EXTENSION CONNECTION** These wires are for use with an aftermarket electric speedometer only. The VSS Lead Wires, 510730, bag V, will plug on here. Refer to that instruction sheet for wire functions and additional directions.
- 19 LIGHTER** Orange Connect to lighter. (battery feed)(use as is with extension for Camaro or remove extension for use on Nova)
- 20 RH COURTESY LIGHT** Plug this connector into the mating connector from the courtesy light kit bag N, 500708.
 - Orange 12 volt battery feed to light.
 - White Ground circuit for light.
- 21 HEATER RESISTOR** Plug this connector onto the factory heater resistor located on top of the heater box on non-A/C cars only.
- 22 GLOVE BOX LIGHT** Orange Connect to the original factory glove box light switch. If not using, just unplug and tape back.
- 23 HEATER LIGHT**
 - Gray Heater control light feed.
 - Black Heater control light ground.
- 24 HEATER SWITCH** Plug this connector onto the factory heater switch.
 - Brown 12 volt accessory feed to heater / ac switch (if using factory or aftermarket a/c, use the short brown wire as the accessory feedwire to your a/c harness. If a new A/C harness is needed, please refer to Table A, at right).
 - Yellow Heater resistor.
 - Lt Blue Heater resistor.
 - Orange Heater resistor.
- 25 GROUND** Black/Wht Connect to a good chassis ground. This is the ground circuit for the electric speedometer. This must be a unique ground point from #'s 9 or 15.

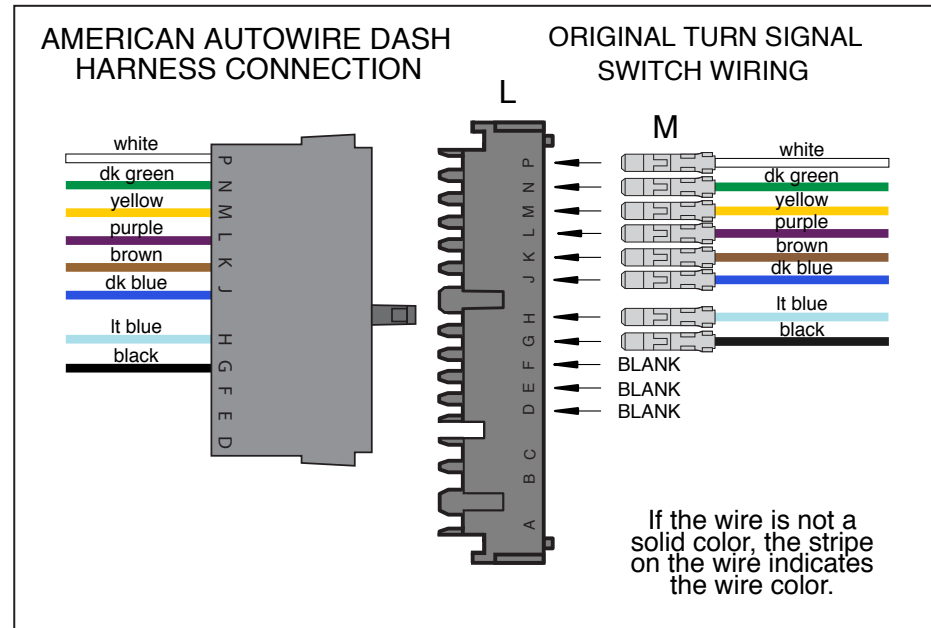

AAW Turn Signal Switch Wires to Stock Steering Columns.

DIAGRAM G

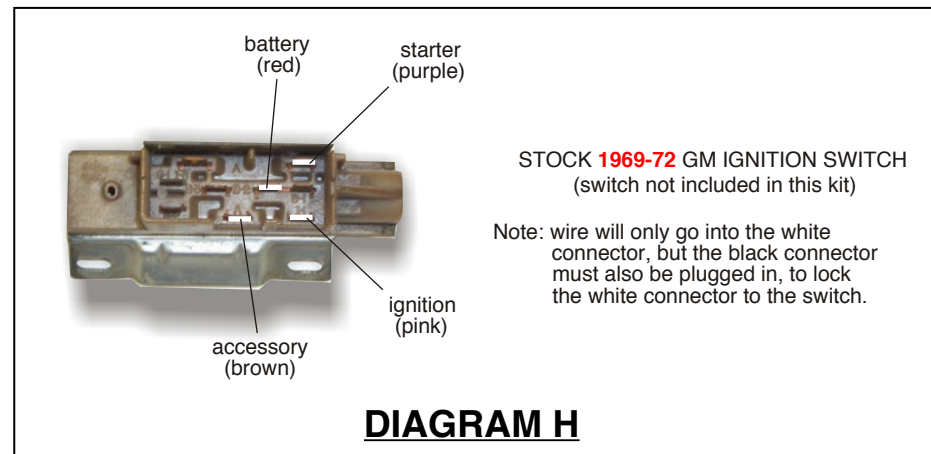

STOCK 1969-72 GM IGNITION SWITCH (switch not included in this kit)

Note: wire will only go into the white connector, but the black connector must also be plugged in, to lock the white connector to the switch.

DIAGRAM H

Factory A/C Harnesses

1968 Nova	NV85279
1969 Camaro, 1969-70 Nova	CA97546
1971 Nova	NV11892
1972 Nova	NV28041

TABLE A



www.americanautowire.com

1969 Camaro
1968-72 Nova
DASH KIT
510512

92972445 Rev 0.0 8/13/2019

THIS PAGE HAS BEEN
INTENTIONALLY LEFT BLANK



www.americanautowire.com

1969 Camaro
1969-72 Nova
DASH KIT
510512
92972445 Rev 0.0 8/13/2019

Classic Update Series

REFER TO SHEETS 2-5 FOR CONNECTING TO A STOCK INSTRUMENT CLUSTER. IF USING A FACTORY DASH CIRCUIT BOARD, BE SURE TO INSTALL THE WIRES AS SHOWN FOR WITH OR WITHOUT, FACTORY GAUGES.

NOTE: If you are using console gauges, connections for the console are included in 500664 kit (bag K). Refer to sheet 6 for generic directions to connect after market gauges. Terminals have been provided in the (92965220) loose piece kit.

CONNECTOR E - Plug this connector into the mating connector on the dash harness (bag G) and connect wires as follows:

DARK BLUE	Right Dash Indicator	Route this wire to the circuit board and cut to length. Install terminal C, and plug into connector D in the location shown on sheet 2, 3, 4, or 5.
LIGHT BLUE	Left Dash Indicator	Route this wire to the circuit board and cut to length. Install terminal C, and plug into connector D in the location shown on sheet 2, 3, 4, or 5.
LIGHT GREEN	Hi Beam Indicator Light	Route this wire to the high beam light socket location at the top of the instrument cluster, and cut to length. Install lamp socket B, and rivet A. Install this into the hi beam hole on the instrument cluster.
DARK GREEN	Water Temp Sender	Route this wire to the circuit board and cut to length. Install terminal C, and plug into connector D in the location shown on sheet 2, 3, 4, or 5.
DARK BLUE	Oil Pressure Sender	Route this wire to the circuit board and cut to length. Install terminal C, and plug into connector D in the location shown on sheet 2, 3, 4, or 5. (Note: Valid only on an original warning light cluster.)
TAN	Gas Gauge	Route this wire to the circuit board and cut to length. Install terminal C, and plug into connector D in the location shown on sheet 2, 3, 4, or 5.
TAN (no printing)	Brake Light Switch	Route this wire to the circuit board and cut to length. Install terminal C, and plug into connector D in the location shown on sheet 2, 3, 4, or 5.

CONNECTOR G - Plug this connector into the mating connector on the dash harness (bag G) and connect wires as follows:

PINK	12v Ignition	Route this wire to the circuit board and cut to length. Install terminal C, and plug into connector D in the location shown on sheet 2, 3, 4, or 5.
GRAY	Dash Lights	Route this wire to the circuit board and cut to length. Install terminal C, and plug into connector D in the location shown on sheet 2, 3, 4, or 5.
BLACK	Ground (Camaro)	Route this wire to the instrument cluster and cut to length. Install ring terminal E and attach to the cluster's metal housing. This will ground the housing.
	(Nova)	Route this wire to the instrument cluster and cut to length. Install terminal J, plug into connector K and install onto cluster ground. This will ground the cluster.

CONNECTOR H - The wires in this connector are used ONLY with an electronic speedometer.

PURPLE	VSS Signal	This wire will plug into the dash harness connection in bag G. Connect the other end to the speedometer 'sender' terminal following the manufacturer's instructions.
YELLOW	VSS Ground	This wire will plug into the dash harness connection in bag G. Connect the other end to the ground terminal "-" on the speedometer following the manufacturer's instructions.
PURPLE/WHITE	VSS Power	This wire will plug into the dash harness connection in bag G. Connect the other end to the speedometer sender 'power' terminal following the manufacturer's instructions.
PINK	Speedo Power	This wire will plug into the dash harness connection in bag G. Connect the other end to the speedometer 'power' terminal following the manufacturer's instructions.
BLACK/WHITE	Speedo Ground	This wire will plug into the dash harness connection in bag G. Connect the other end to a good cluster ground following the manufacturer's instructions.

LOOSE WIRES

WHITE	Coil-> Tach	<u>Used ONLY with a tachometer.</u> Plug this wire into connector F, maintaining color continuity with the white "TACH" wire on the mating dash connector.
YELLOW	Clock Feed	If using a factory Tick-Tock Tach (68 Camaro) or dash mounted clock on any 1968-72 Nova, plug this wire onto the clock location (on the tach of a 68 Camaro) on the dash, and attach the other end to the mating connector on the dash harness.
BROWN	Alternator Ign	<u>Used with a stock generator lamp.</u> Route this wire to the circuit board and cut to length. Install terminal C, and plug into connector F in the location shown on sheet 2, 3, 4, or 5.

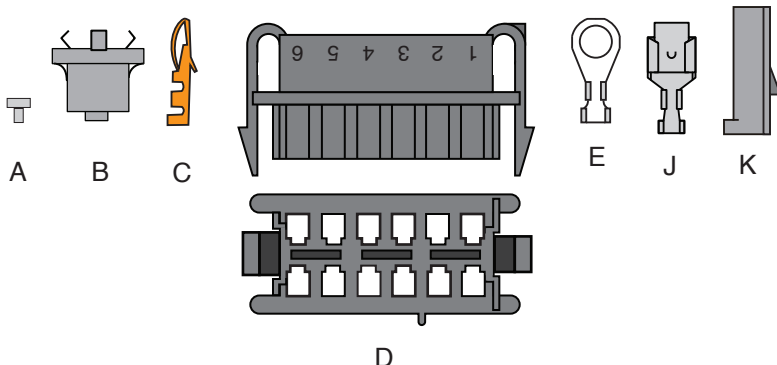

Classic Update Series
 1967-68 Camaro
 1968 & 69-72 Nova
 1967-68 Firebird

bag
H

INSTRUMENT
 CLUSTER
 510509

92972431 instruction rev 0.0 7/21/2019

**USE THIS SHEET TO CONNECT TO AN ORIGINAL 1968 and 1969-72 NOVA
FACTORY INSTRUMENT CLUSTER WITH A CIRCUIT BOARD CONNECTION**

NOTE: This kit will not support the use of a factory installed ammeter

**CIRCUIT BOARD CONNECTOR
WITHOUT CONSOLE GAUGES**

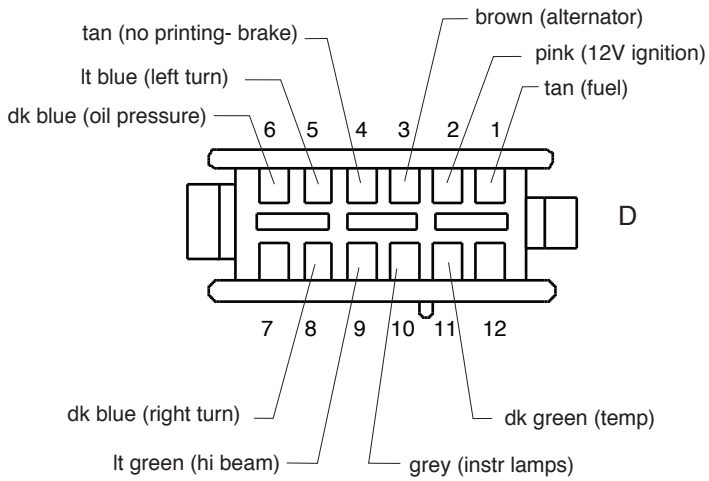

**CIRCUIT BOARD CONNECTOR
WITH CONSOLE GAUGES**

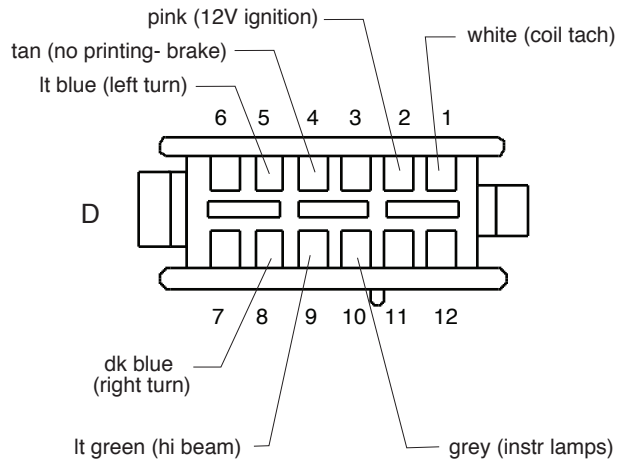

Classic Update Series

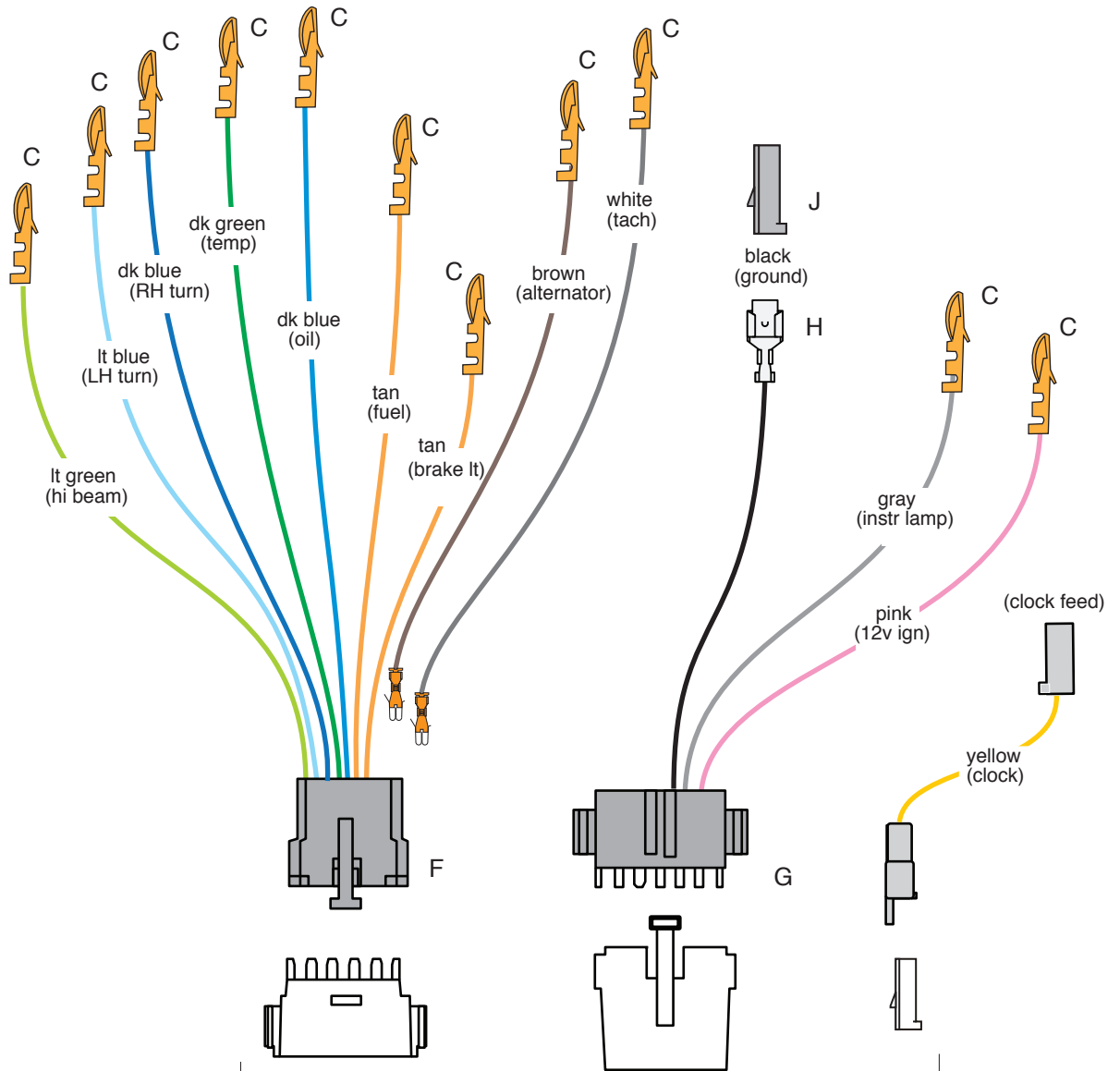

dash harness connectors (bag G)

Gauge Cluster harness (aftermarket gauges) installation instructions:

Classic Update Series

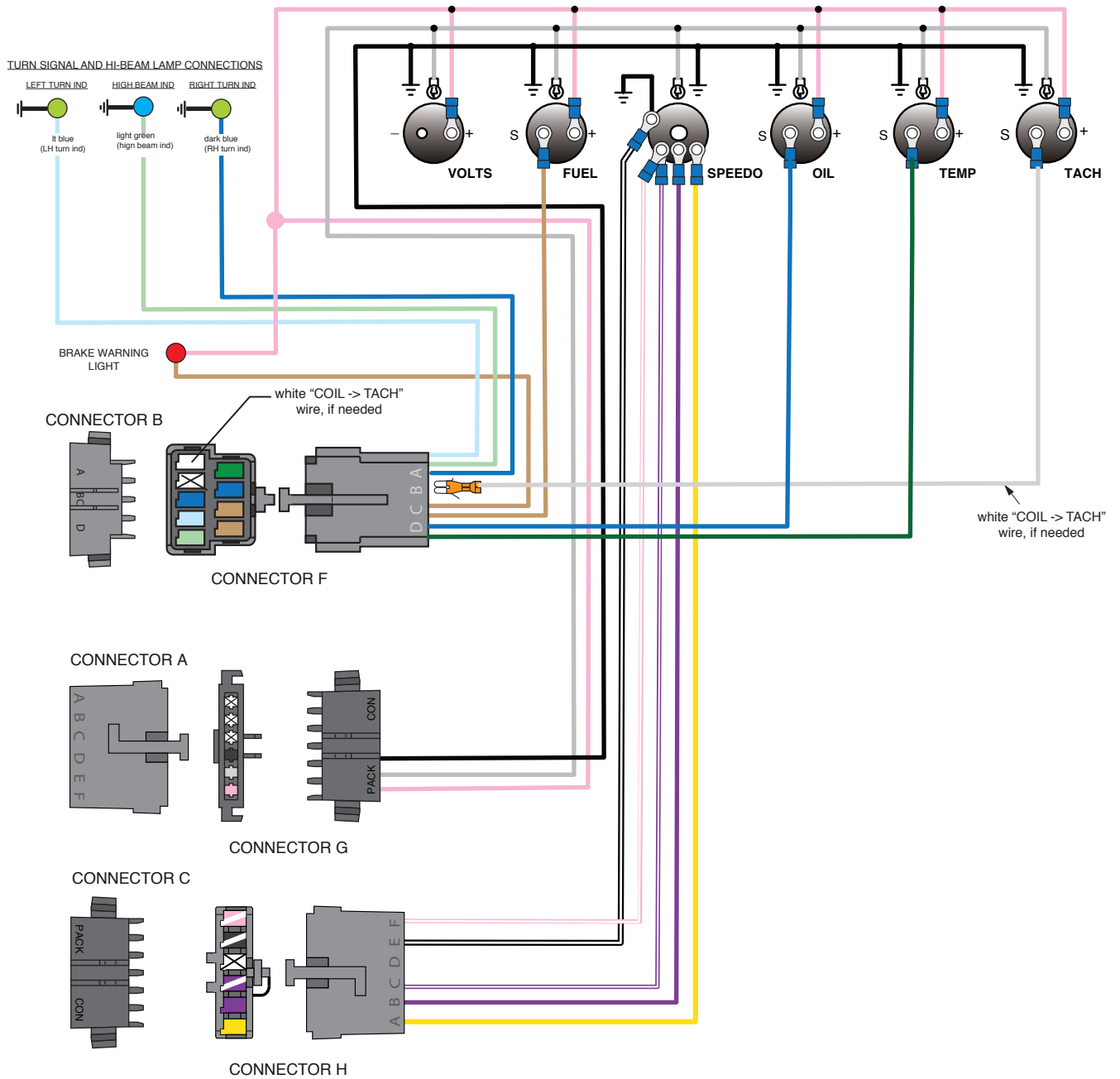

dash harness connectors (bag G)

NOTE: These are general instructions for hooking up aftermarket gauges with an electric speedometer. Connector (H) and the instructions in Connector H will ONLY be used in the event that you are utilizing an aftermarket electric speedometer. If your car does NOT have an electric speedometer, the Connector H will NOT be used and should not be plugged onto your dash harness. It is best to consult the speedometer manufacturer's instructions if you have any questions.

- Yellow** VSS Ground Connect to VSS neg. "-" on speedometer.
- Purple** VSS Signal Connect to VSS input on speedometer.
- Purple/White** VSS Power Connect to 12V power on speedometer.
- Black/White** Speedo Ground Connect to ground on speedometer.
- Pink/White** Speedo Power Connect to 12v power on speedometer.
NOTE: This wire will double onto the same stud as the purple/white VSS power wire from above.

Electric Speedo VSS extension connection:

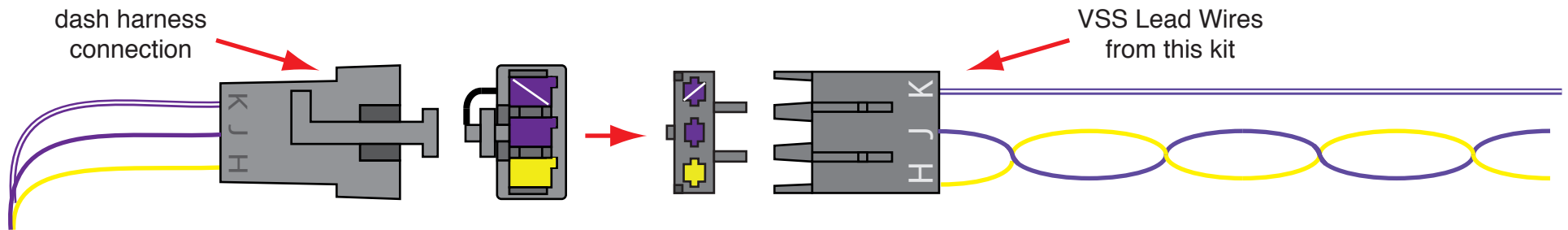

If you are using an aftermarket electric speedometer in your vehicle, you will need to connect the vehicle speed sensor (VSS) Lead Wires from this kit to the dash side connection of your dash harness. The yellow and solid purple wires must remain twisted together as shown above. These three wires will need to pass through the firewall or floor of your vehicle down to the vehicle speed sensor unit in the transmission. Generally, the solid purple wire connects to the “signal” lead, the yellow wire connects to the “ground” lead, and the purple/white stripe wire connects to the “12 volt power” lead on the vehicle speed sensor assembly. However, you should consult the directions that came with your gauges, and connect your vehicle speed sensor per the manufacturer’s instructions.



www.americanautowire.com 856-933-0801

VSS LEAD WIRES
Various Applications
Classic Update Series

510730

92972371 Rev 0.0 4/9/2019

bag
V



www.americanautowire.com 856-933-0801

TYPICAL AFTERMARKET GAUGE CONNECTIONS
(STUD TYPE CONNECTIONS SHOWN)

GAUGE CONNECTIONS

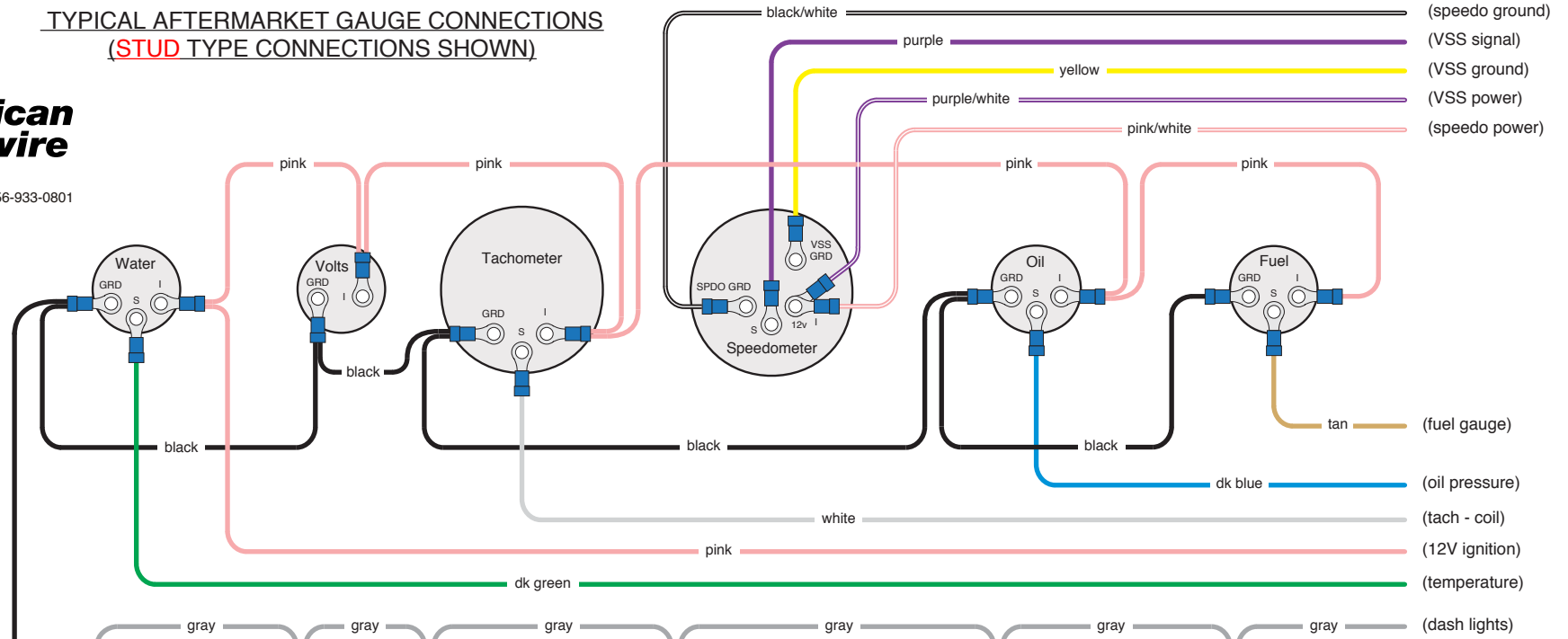

LAMP CONNECTIONS

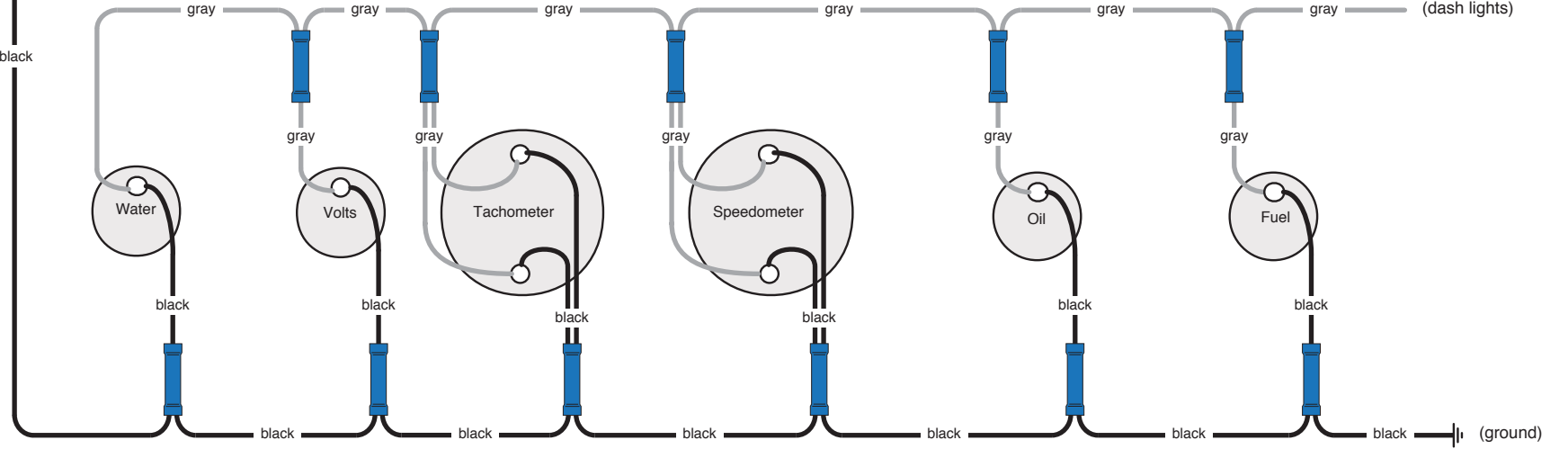

TURN SIGNAL AND HI-BEAM LAMP CONNECTIONS

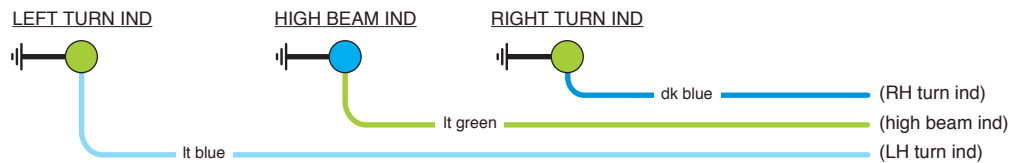

PART # **92965220**
Gauge Connection Kit
 Complete connections
 for aftermarket gauges
 92965221 Rev 1.1 12/12/2014



www.americanautowire.com 856-933-0801

TYPICAL AFTERMARKET GAUGE CONNECTIONS
(BLADE TYPE CONNECTIONS SHOWN)

GAUGE CONNECTIONS

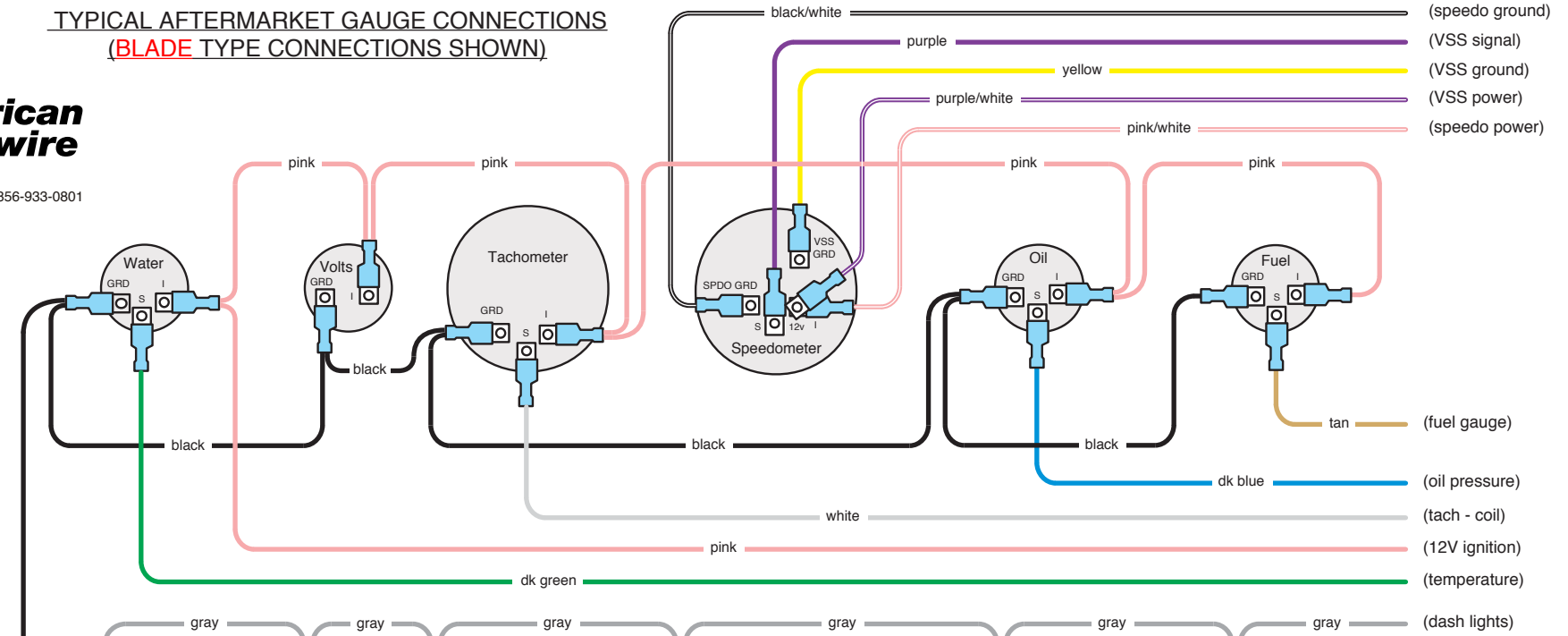

LAMP CONNECTIONS

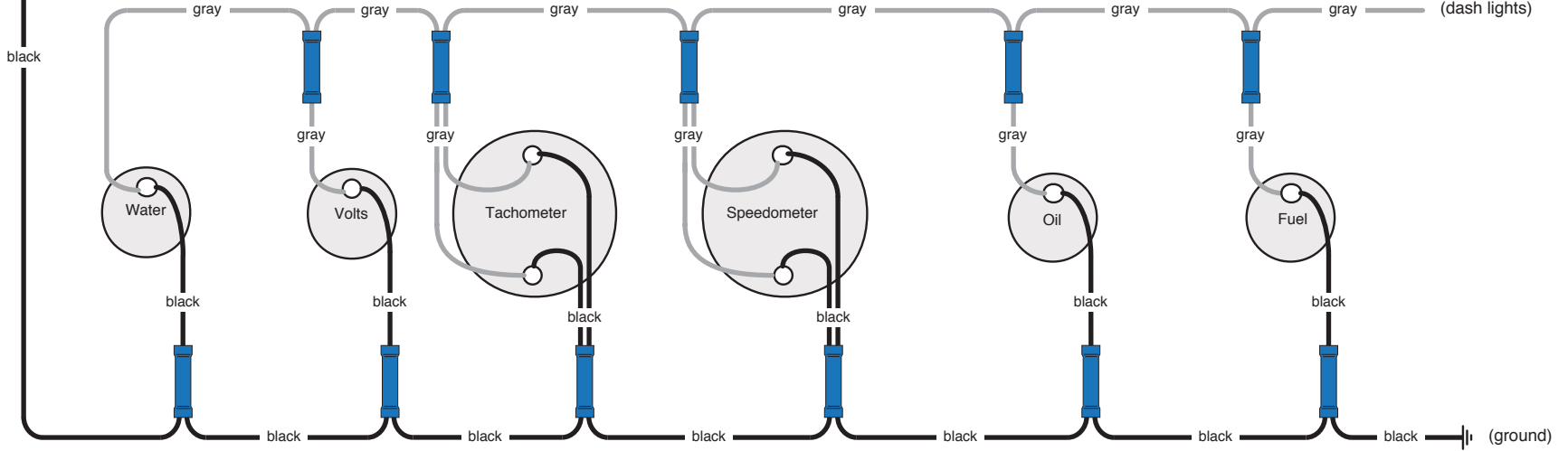

TURN SIGNAL AND HI-BEAM LAMP CONNECTIONS

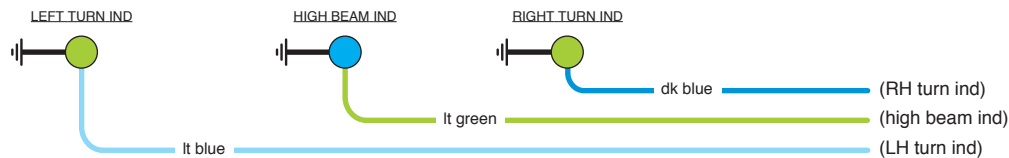

PART # **92965220**
Gauge Connection Kit

Complete connections
for aftermarket gauges

92965221 Rev 1.1 12/12/2014

Classic Update Series

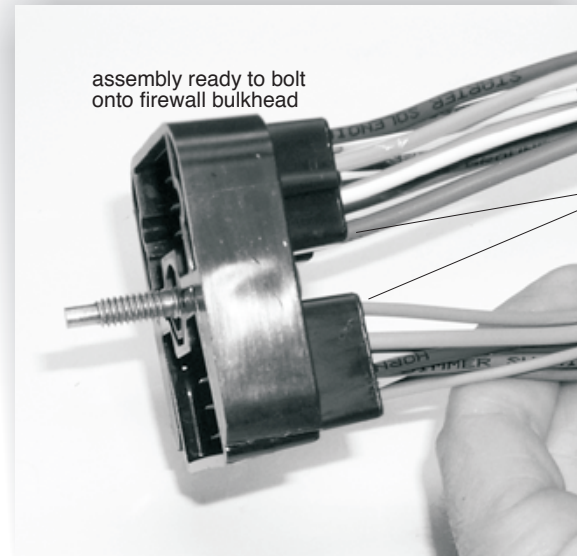
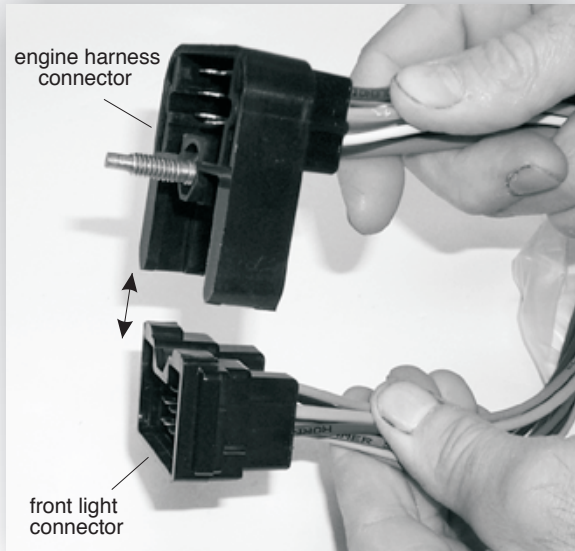

apply silicone sealant to back side of connector after installing terminals

The bulkhead connector from this Engine kit must snap into the mating engine connector (bag L), as shown. After snapping together, then bolt the assembly into the dash harness firewall connector using the attached bolt.

Look!



American Autowire also sells factory OEM style harness wrap. This is the same stuff used on original engine harnesses! If you want that OEM look with your Classic Update wiring system, then give us a call and order p/n R0067108!



**American
Autowire**

www.americanautowire.com 856-933-0801

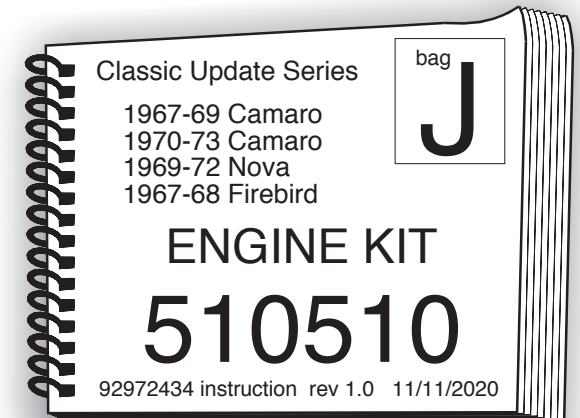

Terminals used in this installation.

This kit contains loose piece terminals and connectors necessary to complete a connection to a specific component. Each connection on the instruction sheet identifies specific parts by a letter code that corresponds to the letter code on a part picture identified below. The parts below are shown in actual size to help in identification. This kit will only contain those parts required for the connections in the specific sub-kit you are working on. Just match the part to the picture below to identify the part letter code you will see on the instruction sheet for the sub-kit harness you are working on. We have supplied additional terminals in the event that extra terminals are necessary.

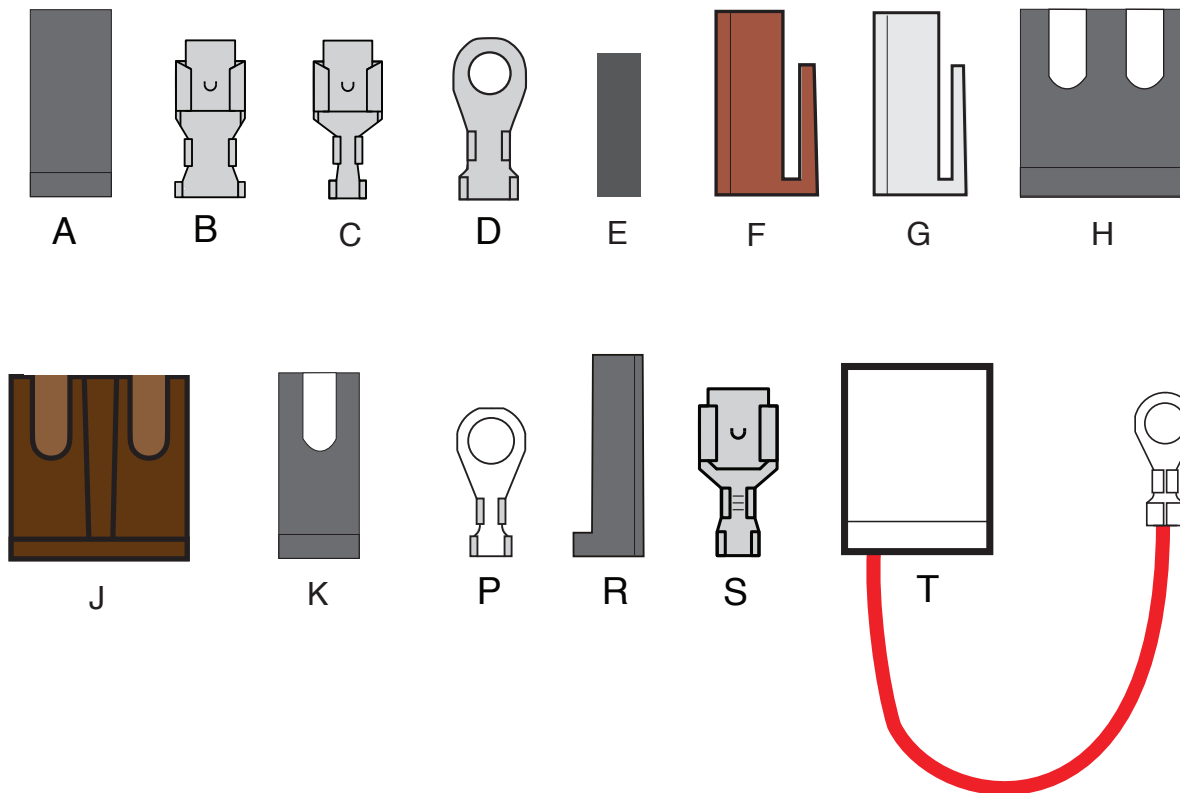

**American
Autowire**

www.americanautowire.com 856-933-0801

ENGINE KIT

510510

92972434 instruction rev 1.0 11/11/2020

ALTERNATOR BOOT
(FROM 510476 KIT)

10 GA. RED (12 V BATTERY)
(FROM 500668 KIT)

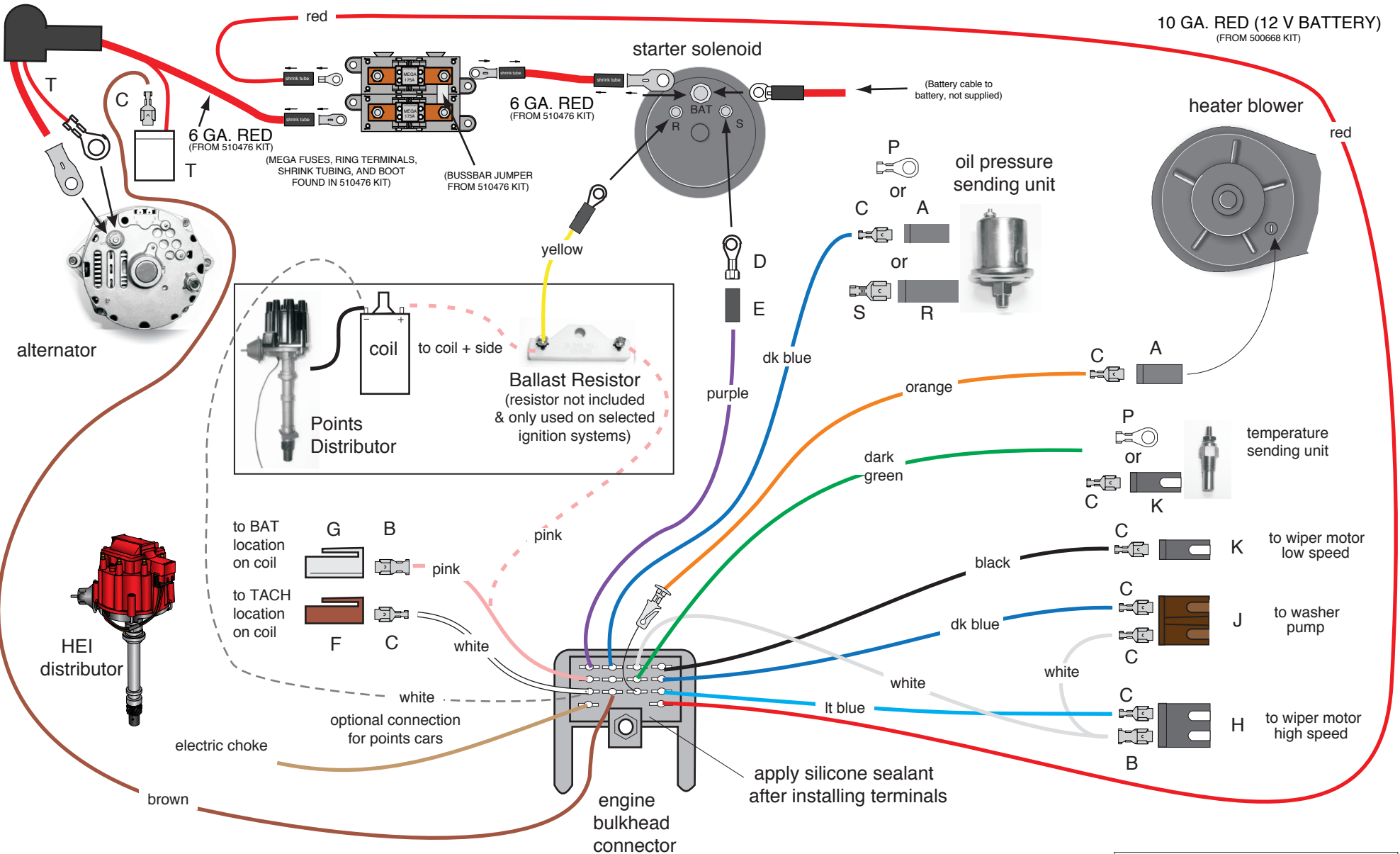

NOTE: See page 5 of this instruction set for some typical wiper connection photographs



ENGINE KIT
510510
92972434 instruction rev 1.0 11/11/2020

TEMPORARILY, PLUG THE MAIN BULKHEAD CONNECTOR FROM THIS KIT INTO THE MATING CONNECTOR ON THE DASH BULKHEAD CONNECTOR (LOCATED UNDER THE MASTER CYLINDER) Note: This will be unbolted to install the front light harness later.

BULKHEAD CONNECTOR WIRES:

RED	12V BATTERY	Route this wire to the Megafuse and cut to length. Use ring terminal, shrink tubing from 510476 kit. Connect as shown on sheet 3.
PURPLE	STARTER SOLENOID	Route to the starter solenoid and cut to length. Install rubber sleeve E and ring D. Connect to the 'S' terminal on solenoid.
DK BLUE	OIL PRESSURE SENDER	Connect this wire to the oil pressure sending unit. Using terminal P, terminal C with connector A, or terminal S with connector R.
ORANGE	HEAT / AIR	If using after-market air conditioning, this wire will not be used. If using a stock heater only system, route this wire to the heater blower, cut to length. Install terminal C and connector A and plug into the blower unit. Plug the other end into the engine bulkhead connector as shown on sheet 3.
DK GREEN	WATER TEMP SENDER	Connect this wire to the temperature sending unit using terminal P or terminal C with connector K (depending on your sending unit).
PINK	12V IGNITION	If using an HEI distributor, or after-market ignition system which requires a 12V feed: Route the PINK wire to the coil and trim to length. Install terminal C and connector G, and plug into distributor cap BAT location.
PINK	12V IGNITION	If using a points type ignition system which required reduced voltage:
YELLOW	STARTER SOLENOID-R	Route the PINK wire to the ignition feed side of the ballast resistor (not included in this kit). Connect the loose piece YELLOW (STARTER SOLENOID-R) wire to the R terminal on the starter and connect the other end to the coil side of the ballast resistor (not included in this kit). Connect a piece of the left over PINK wire to the coil side of the ballast resistor and route the to the distributor coil + side. Connect the distributor input lead wire to the coil negative (-) side.
WHITE	COIL-TACH	Route this wire to he coil and trim to length. If using an HEI distributor, terminal B and connector F are included for connection. Plug into the TACH location on the HEI distributor, or attach to the negative side of coil in a points type system.
TAN	ELECTRIC CHOKE	If you are using a carburetor with an electric choke, connect this wire to the electric choke connection. If you are not using an electric choke or a turbo 400 transmission, remove this wire from the engine bulkhead connector

The following wires are for use on a stock wiper system. If using an after-market wiper system, follow the manufacturer's instructions (see sheets 3 and 5 for details).

BLACK	WIPER LOW SPEED	Route to the wiper motor and trim to length. Install terminal C, plug into connector K, and plug into the low speed terminal of the wiper motor as shown on sheet 5.
DK BLUE	WIPER WASHER	Route this wire to the washer pump and trim to length. Install terminal C and plug into BROWN connector J in the location shown on sheet 3.
LT BLUE	WIPER HI SPEED	Route this wire to the wiper motor and trim to length. Install terminal C and plug into BLACK connector H in the location shown on sheet 3.
WHITE	WIPER ACC	Route this wire to the wiper motor and trim to length. Double it with the cut off portion, install terminal B and plug into the open cavity of connector H as shown on sheet 3. Route the loose end of this wire to the washer pump, install terminal C and plug into open cavity of connector J as shown on sheet 3. Plug connector H onto the high speed terminals of the wiper motor as shown on sheet 5. Plug connector J onto the washer pump terminals of the wiper motor as shown on sheet 5.

ALTERNATOR WIRES:

HEAVY RED		Use the 6ga red wire, boot and ring terminal from the 510476, route from alternator to the Megafuse and cut to length. Connect as shown on sheet 3.
SMALL RED		Send the ring terminal end of pigtail T through the boot (as shown on sheet 3) and connect to the battery stud on alternator. Do not plug the connector into the alternator yet as the exciter wire (Brown) needs to be added before the connector is plugged in.
BROWN	ALTERNATOR IGN	Route this wire to the alternator and cut to length. Install terminal C and plug into the regulator connector as shown on sheet 3.

Once the main connector has all of it's wires plugged in, the connector cavities should be sealed with di-electric grease on the terminals. Also, to assure a moisture resistant seal, silicone can be applied to seal the outside of the connector.

ENGINE KIT

510510

92972434 instruction rev 1.0 11/11/2020

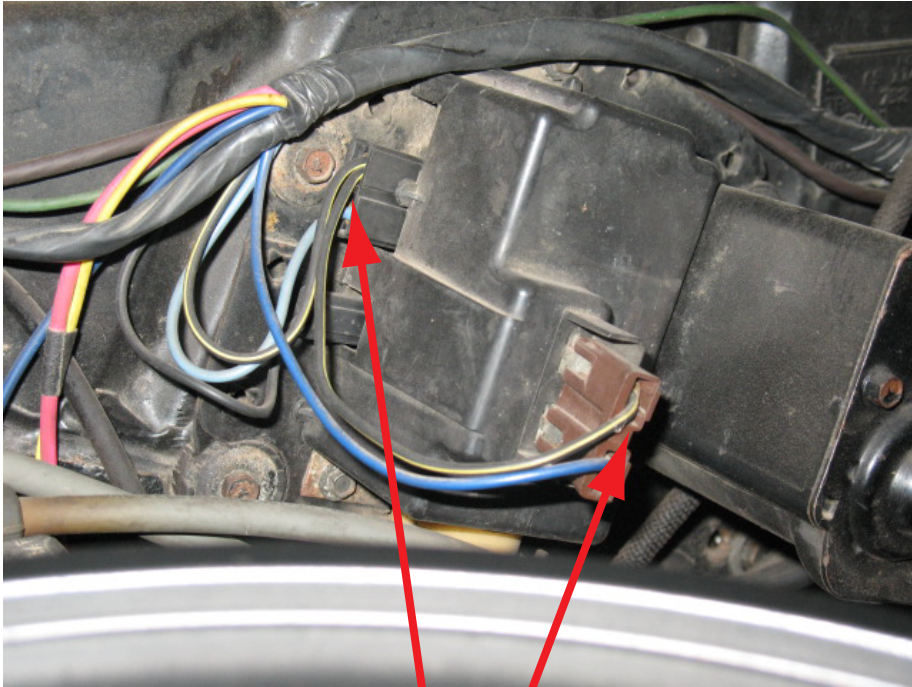

The photo above depicts the typical stock 1967-1969 Camaro (all), 1968-1972 Nova (all), 1967-1968 Firebird (all), and 1970-73 Camaro “without depressed park” wiper motor and washer pump connections. Where you see the black wire with the yellow strip in the photo, that would be equivalent to the AAW white “wiper feed” power wire.

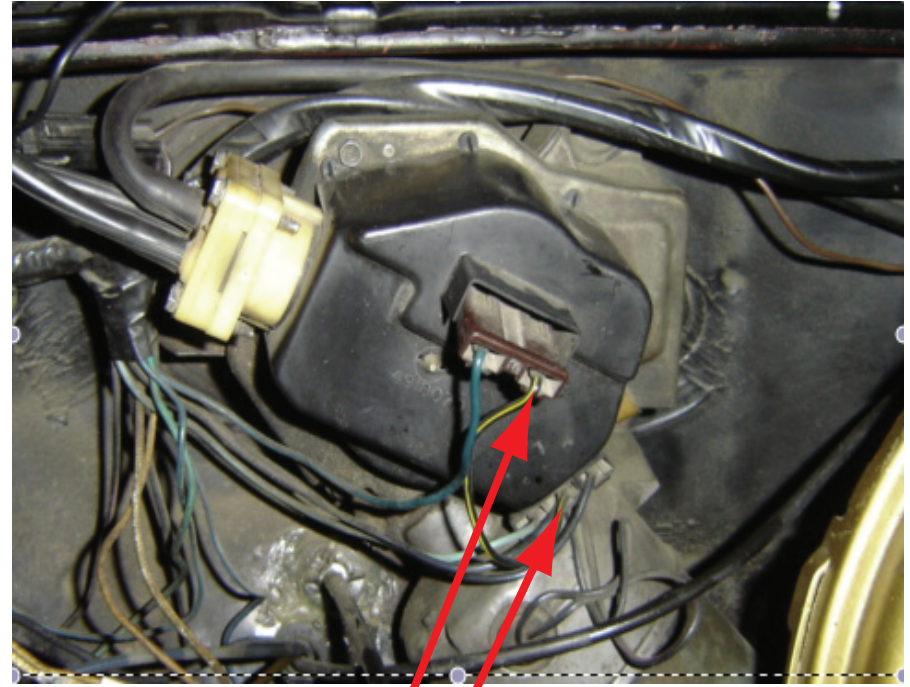

The photo above depicts the typical stock 1970-73 Camaro “with depressed park” wiper motor and washer pump connections. Where you see the black wire with the yellow strip in the photo, that would be equivalent to the AAW white “wiper feed” power wire.

This page intentionally left blank



www.americanautowire.com 856-933-0801

ENGINE KIT

510510

92972434 instruction rev 1.0 11/11/2020

Classic Update Series

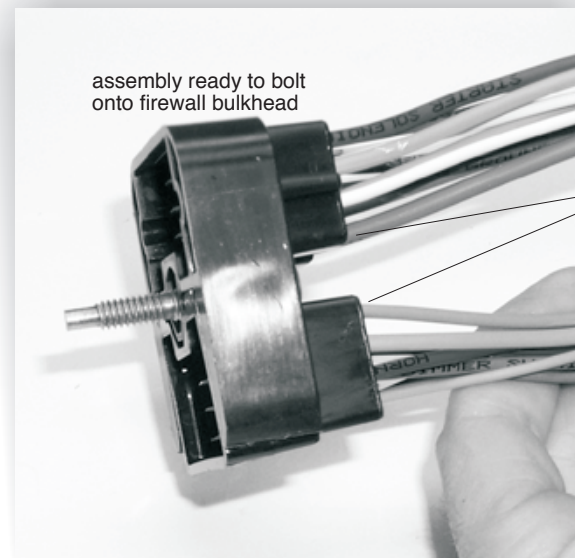
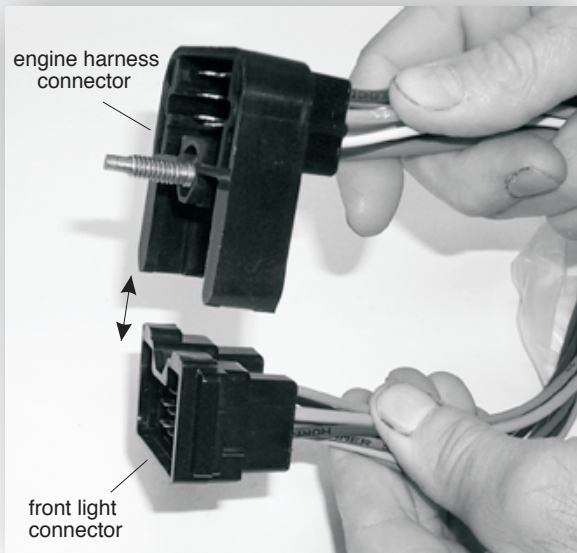

The bulkhead connector from this front light kit must snap into the mating engine connector (bag J), as shown. After snapping together, then bolt the assembly into the dash harness firewall connector using the attached bolt.

Look!



American Autowire also sells factory OEM style harness wrap. this is the same stuff used on original Camaro harnesses! If you want that OEM look with your Classic Update wiring system, then give us a call and order p/n R0067108 !



**American
Autowire**

www.americanautowire.com 856-933-0801



Terminals used in this installation.

This kit contains loose piece terminals and connectors necessary to complete a connection to a specific component. Each connection on the instruction sheet identifies specific parts by a letter code that corresponds to the letter code on a part picture identified below. The parts below are shown in actual size to help in identification. This kit will only contain those parts required for the connections in the specific sub-kit you are working on. Just match the part to the picture below to identify the part letter code you will see on the instruction sheet for the sub-kit harness you are working on. We have supplied a few additional terminals in the event that extra ones are necessary.

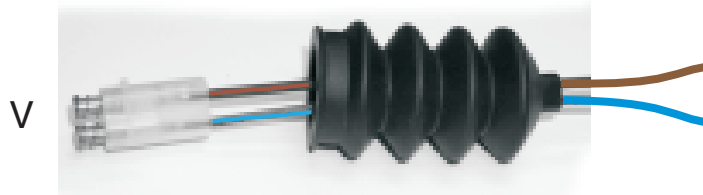
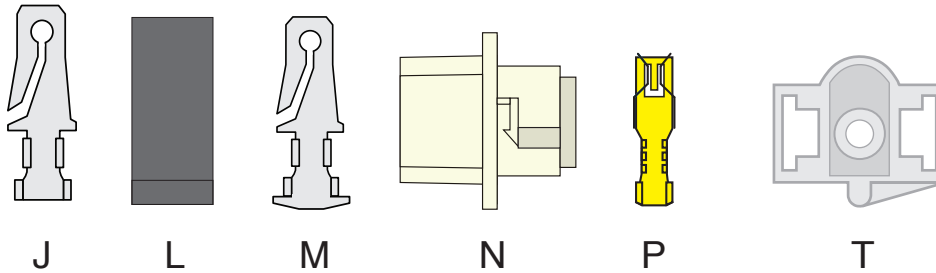
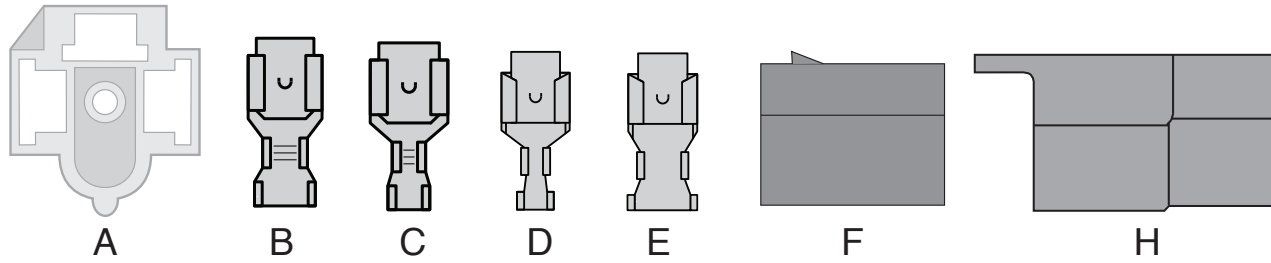

REF: These extensions
can be found in [500737](#)

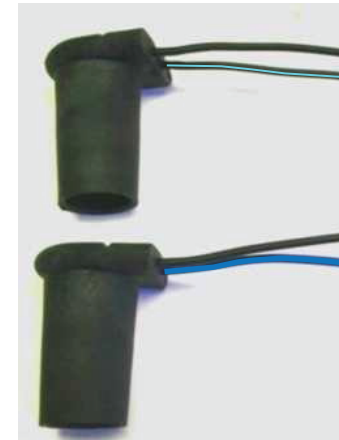

REF: These extensions
can be found in [500887](#)

FRONT LIGHT KIT

510511

92972437 instruction rev 0.0 7/21/2019

Classic Update Series

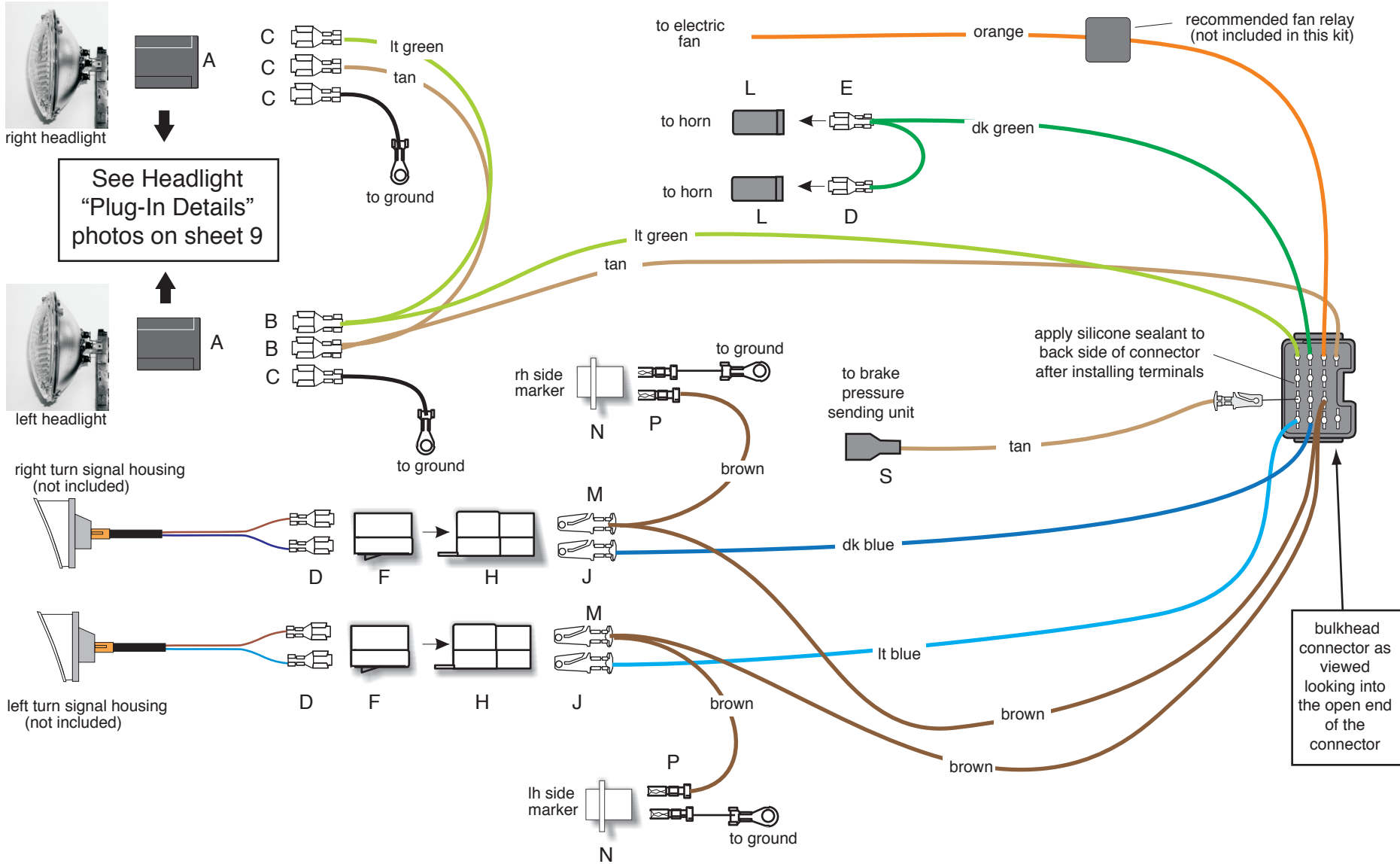

1969-72 Nova, All
 1967-68 Camaro, Rally Sport Front Light
 1969 Camaro, Standard and Rally Sport Front Light
 1970-73 Camaro, Standard and Rally Sport Front Light

FRONT LIGHT KIT
510511
 92972437 instruction rev 0.0 7/21/2019

1967-68 Camaro Rally Sport Front Lighting, 1969 Camaro Standard and Rally Sport Front Lighting 1969-72 Nova Front Lighting, 1970-73 Camaro Standard and Rally Sport Front Lighting

Connect the bulkhead connector from this kit onto the bulkhead connector from the engine kit (bag J), and bolt to the firewall dash bulkhead.

LIGHT BLUE	LEFT FRONT TURN	Route this wire to the LH turn signal lamp install terminal J, and plug into connector H as shown on sheet 5.
DARK BLUE	RIGHT FRONT TURN	Route this wire to the RH turn signal lamp install terminal J, and plug into connector H as shown on sheet 5.
BROWN	PARK LIGHTS	Route one of the brown wires from the bulkhead connector to the LH (driver side) turn signal lamp and cut to length. Double this wire with the cut off portion, install terminal M, and plug into connector H with the light blue wire from above as shown on sheet 5. Route the other end of this brown wire connection to the LH side marker lamp, cut to length, install terminal P, and plug this connection into the LH side marker lamp socket N as shown on sheet 5. (Also plug the pre-assembled black ground wire into lamp socket N, as shown on sheet 5.) Route the other brown wire from the bulkhead connector to the RH turn signal lamp and cut to length. Double this wire with the cut off portion, install terminal M, and plug into connector H with the dark blue wire from above as shown on sheet 5. Route the other end of this brown wire connection to the RH side marker lamp, cut to length, install terminal P, and plug this connection into the RH side marker lamp socket N as shown on sheet 5. (Also plug the pre-assembled black ground wire into lamp socket N, as shown on sheet 5.)

NOTE: The running and directional light assemblies use factory parking lamp housing assemblies that are not serviceable. To connect them, plug completed connector H (on the wires above) onto the factory parking lamp housing assemblies as shown on sheet 5. New terminals D and connectors F have been provided in the event that your originals are damaged or are missing.

TAN	HEADLIGHT LOW BEAM	Route this wire to the LH (driver side) headlight and trim to length. Double this wire with the cut off portion, and install terminal B. Plug this terminal into connector A, in the location shown on sheet 9. Route the remaining portion of this tan wire to the RH (passenger side) headlight and trim to length. Install terminal C and connector A, in the location shown on sheet 9.
LIGHT	HEADLIGHT LOW BEAM	Route this wire to the LH (driver side) headlight and trim to length. Double this wire with the cut off portion, and install terminal B. Plug this terminal into connector A, in the location shown on sheet 9. Route the remaining portion of this tan wire to the RH (passenger side) headlight and trim to length. Install terminal C and connector A, in the location shown on sheet 9.
BLACK	GROUND	Install terminal C and plug into connector A, in the location shown on sheet 9. Connect the ring terminal to a good chassis ground. Complete for each headlight.
DARK GREEN	HORN	Route to horns and install terminals D & E, as shown on sheet 5, Plug into connectors L.
ORANGE	ELECTRIC FAN	Route to the electric fan, and connect per manufacturer's instructions. NOTE: We recommend that this wire be used as the trigger wire for the electric fan relay. American Autowire manufactures relay kits for this application.
TAN	BRAKE LIGHT SWITCH	Plug wire pigtail S into the front light connector in the location shown on sheet 5. Plug the other end onto the stock brake sender switch as shown on sheet 5.

Headlight Connector “Plug-In Details”



1967-73 Camaro All
1968-72 Nova All

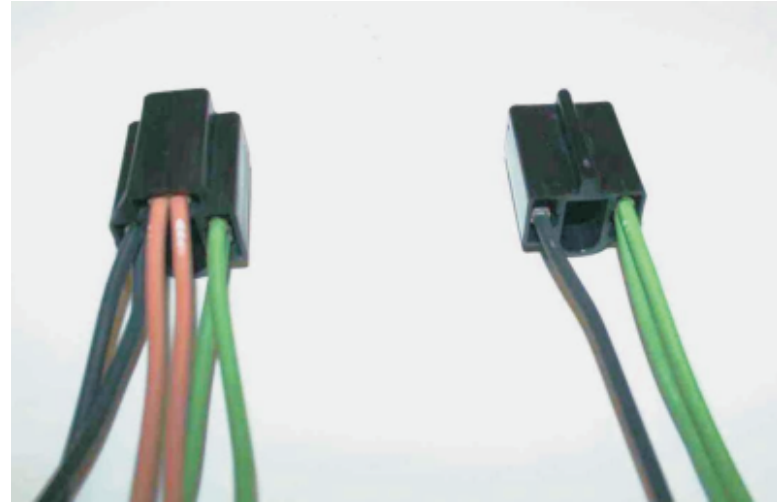

1967-68 Firebird (only)

FRONT LIGHT KIT

510511

92972437 instruction rev 0.0 7/21/2019

This page intentionally left blank

FRONT LIGHT KIT

510511

92972437 instruction rev 0.0 7/21/2019

A  (1)
 (144.0" 6 Gauge charge wire)

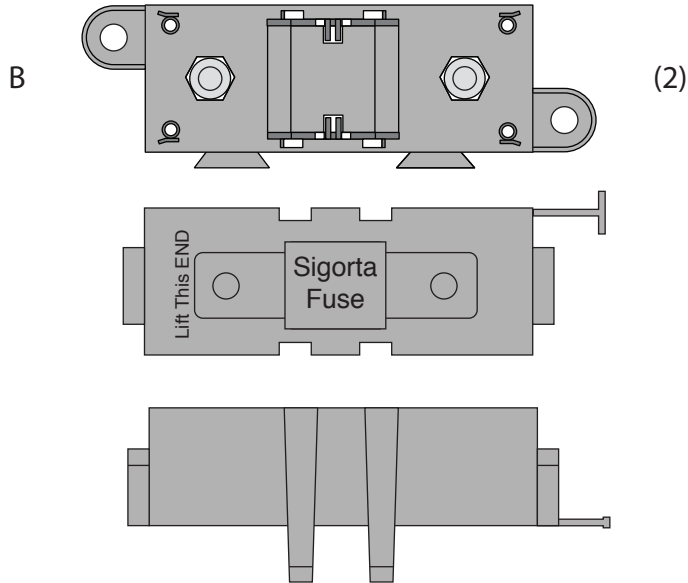

1. On this page, you will find the wire, fuse bodies, fuses, boot, ring terminals, and shrink tubing (items A through K) that are necessary to connect your alternator and main power feed for your new AAW wiring kit. Please be sure that all of the necessary components are present before starting this portion of your installation. If anything is missing, stop what you are doing and contact AAW at the number listed below right away.

2. On page 2, you will find directions for building the 2 Megafuse assemblies (items B,C and D) into one unit.

3. On page 3, you will find an overall concept of how to connect the Megafuse assemblies to your starter solenoid, alternator and main power feed of your new wiring system.

4. On page 4, you will find tips on building your charging circuit wires and assembling them and the main panel power feed wire to the Megafuse assemblies.

(Megafuse body, cover and two M8 x 1.25 nuts / lock washers)

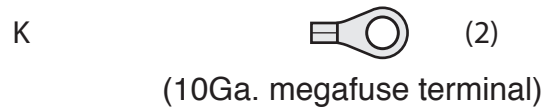
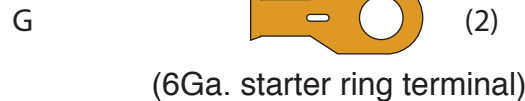
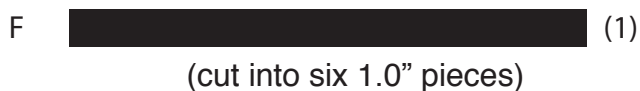
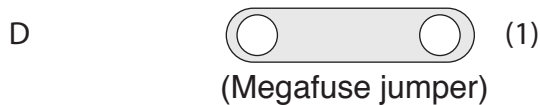
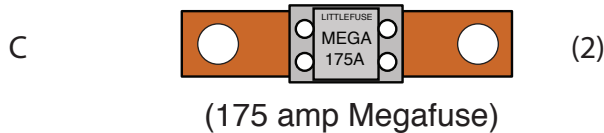

www.americanautowire.com 856-933-0801

PART #

510476

Z

DESCRIPTION:

Alternator and Main Power
 Connection Kit
 Various Applications

92972153 instruction sheet rev 0.1 6/24/2019

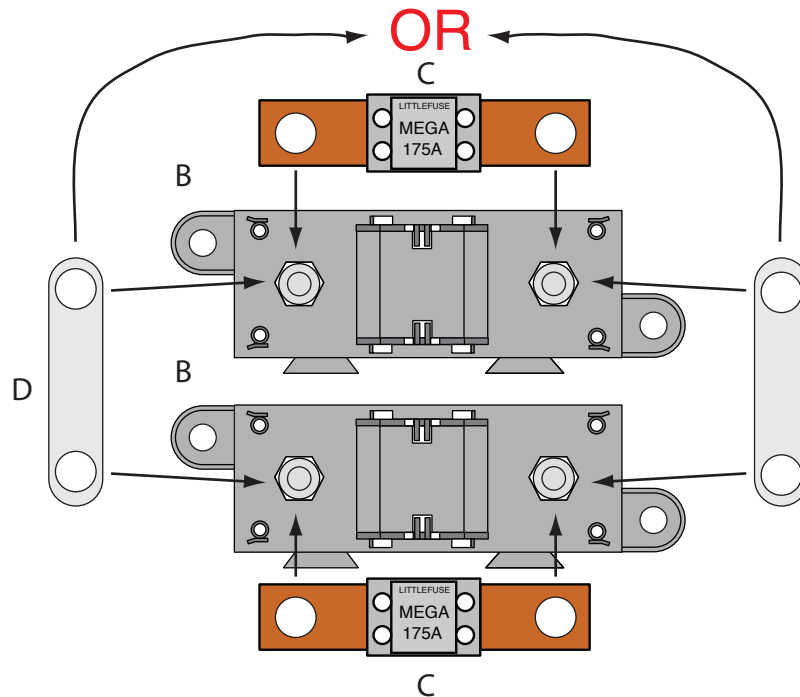

Assembling the (2) Megafuse assemblies

NOTE: Find a suitable place, as close to the battery power source as possible, under the hood of your vehicle to mount the completed Megafuse assemblies. Keep in mind that you have 12 feet of 6Ga. charging wire, and that the main power feed coming from your panel or bulkhead connection must also be able to reach the assembly.

1. Take the two Megafuse bodies and covers (items B) and snap them together. Remove the 4 nuts and lock washers from the studs on the fuse body assemblies.
2. Install the Megafuse jumper (item D above) over two of the studs on the Megafuse bodies. It is very important that the jumper **MUST BE** assembled on the side that is going to connect to your main power connection (starter solenoid or battery feed).
3. Notch top cover to clear jumper D as shown at right.
4. Snap one 175amp fuse (items C) onto the studs of each of the two Megafuse bodies (items B), over the jumper, then loosely re-attach the 4 nuts and lock washers back onto the assembled Megafuses. The fuse assemblies are ready to install into your vehicle.

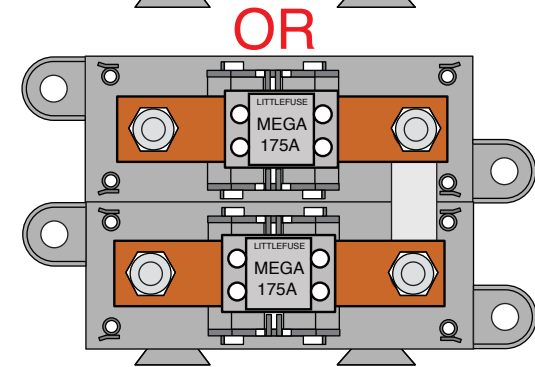
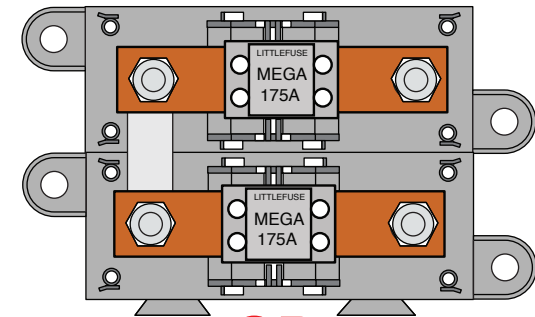

Assembled Megafuses

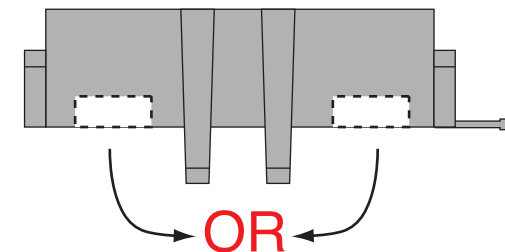

Notched Cover

PART #

510476

Z

DESCRIPTION:

Alternator and Main Power
Connection Kit
Various Applications

92972153 instruction sheet rev 0.1 6/24/2019

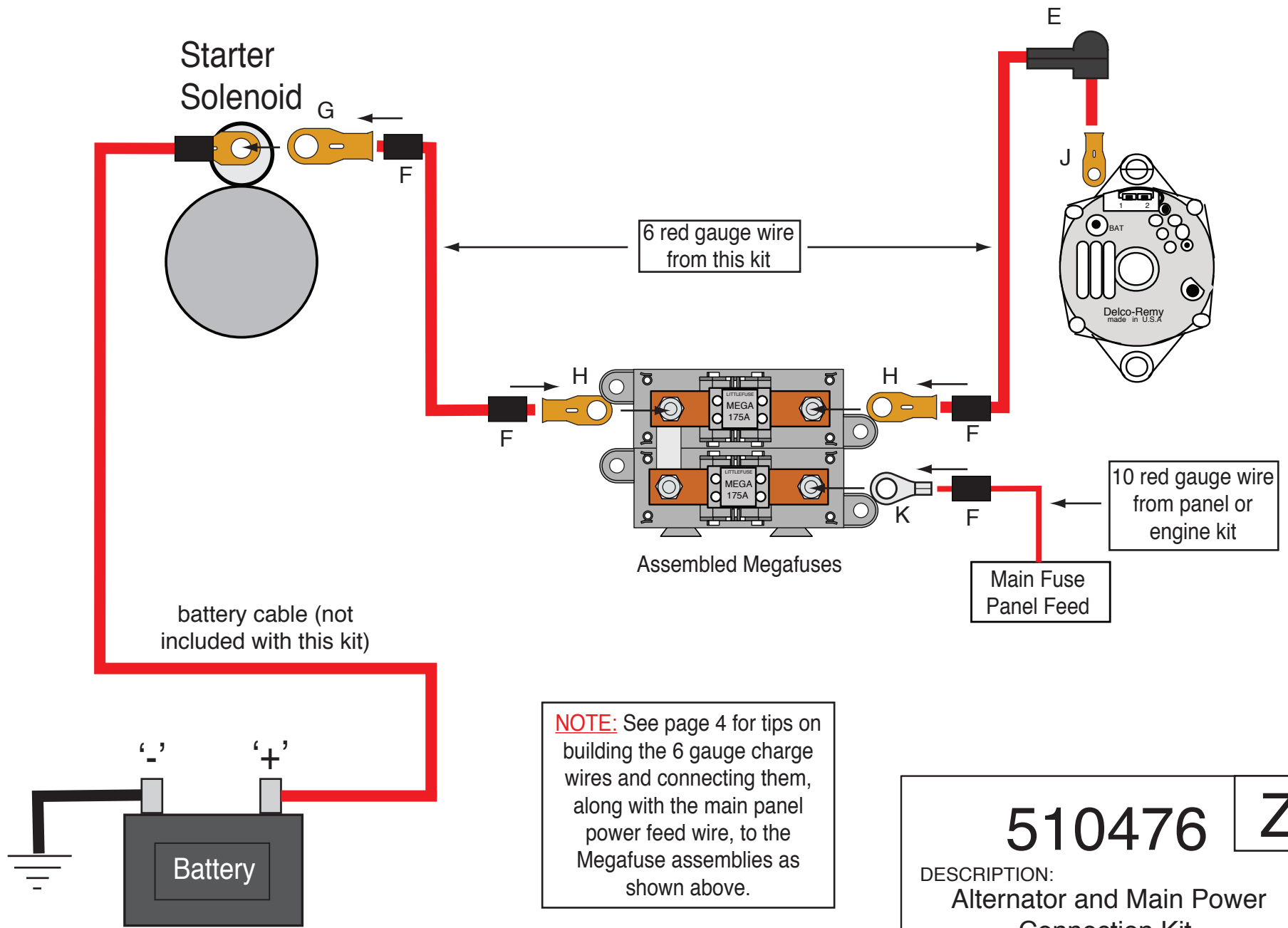

NOTE: See page 4 for tips on building the 6 gauge charge wires and connecting them, along with the main panel power feed wire, to the Megafuse assemblies as shown above.

<h1>510476</h1>	Z
<p>DESCRIPTION: Alternator and Main Power Connection Kit Various Applications</p>	
<p>92972153 instruction sheet rev 0.1 6/24/2019</p>	

Building the 6Ga. charge wires and connecting them and the main panel power feed wire to the Megafuse assemblies:

NOTE: Make sure that your battery is disconnected! You will need to install the preassembled Megafuses from page 2 in your vehicle to start this part of the installation.

1. Pre-cut item F shrink tubing into (6) 1.00" - 1.25" pieces.
2. Take the 12-foot piece of 6Ga. red wire from this kit and route it from your starter (or other battery feed) over to the area where you have mounted your Megafuse and cut it to length. Strip the insulation on each end back 1/2". Install 2 pieces of shrink tubing F onto the wire. At the starter end, crimp and solder (1) of terminal G onto the wire. At the Megafuse end, crimp and solder (1) of terminal H onto the wire. Slide the shrink tubing over the terminals and heat it up to shrink it down.
3. Take the remaining portion of the 12-foot piece of 6Ga. red wire from this kit and route it from your alternator over to the area where you have mounted your Megafuse and cut it to length. Strip the insulation on each end back 1/2". Install 1 piece of shrink tubing F onto the wire. At the alternator end, slip on boot E as shown on page 3, then crimp and solder (1) of terminal J onto the wire. At the Megafuse end, crimp and solder (1) of terminal H onto the wire. Slide the shrink tubing over terminal H and heat it up to shrink it down.
4. Take the 10Ga. red main power feed wire from your engine or panel sub-kit and route it over to the area where you have mounted your Megafuse and cut it to length. Strip the insulation back 3/8". Install 1 piece of shrink tubing F onto the wire, then crimp and solder (1) of terminal K onto the wire.
5. Remove the 4 loosely tightened nuts and lock washers from the assembled Megafuses, then using the drawing on page 3 as a guide, install your pre-assembled wires from steps 2-4 above. Re-install the 4 nuts and lock washers onto the assembled Megafuses and tighten them down. This part of your installation is now complete.

510476

Z

DESCRIPTION:

**Alternator and Main Power
Connection Kit
Various Applications**

92972153 instruction sheet rev 0.1 6/24/2019

Classic Update Series

(All except Camaro Deluxe Interior)

(Camaro Deluxe Interior)

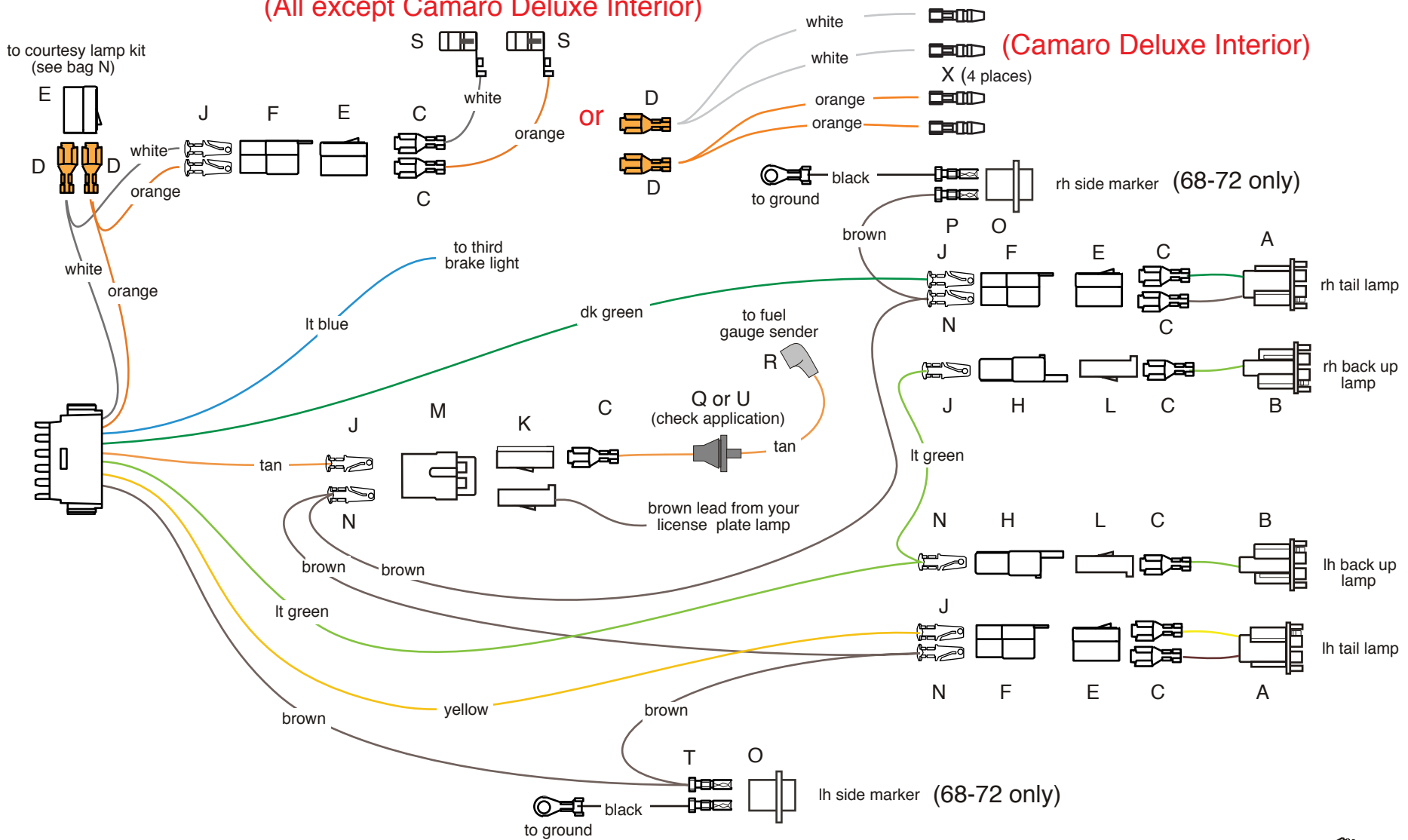

Use the loose piece dk blue wire (power lead) if you are using electric fuel pump.

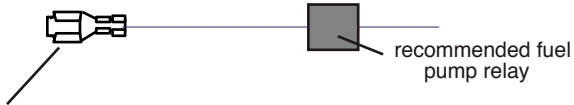

Plug this terminal into the 6 way power feed connector, located on the dash harness.

USE THIS SHEET FOR A
67-68 CAMARO NON-RALLY SPORT CAR
 OR **69-72 NOVA**



www.americanautowire.com 856-933-0801











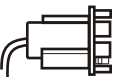
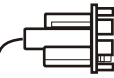







Classic Update Series **M**

REAR BODY KIT

500673

92965933 instruction Rev 4.1 5/12/2017

USE THIS SHEET FOR A **NON-RALLY SPORT CAMARO OR NOVA**

A			Connect the main connector to the mating connector on the dash harness 500662 bag G. Route this harness along door sill and into the trunk.
B		LIGHT BLUE	Third brake light
		TAN	Fuel signal
		TAN	Fuel Tank lead (with rubber end)
C			Plug the rubber end of this wire R onto the sending unit on fuel tank. Route the wire to the stock feed thru hole under fuel tank filler and install rubber grommet Q for a Camaro or U for a Nova in the direction shown on sheet 1. Secure this wire into hole with the attached grommet. In the trunk area, trim this wire to reach connector M from wire above. Attach terminal C and plug into connector K. Plug connector K into mating connector M. This should match the tan wire from above. Your existing license plate lamp wire will also plug into connector M. (Note: Terminal C and connector L are provided if you need to attach to your lamp wire.)
D			
E		BROWN	Parking lamps
F			Route this wire to the left side marker and trim to length. Double this wire with the cut off portion, install terminal T and plug into lamp socket O. Route the loose end to the LH tail lamp, cut to length, double this wire with the cut off portion, install terminal N, and plug this terminal into connector F in the location shown on sheet 1. Route the loose end to connector M (from the tan wire above), and cut to length. Double this wire with the cut off portion, install terminal N and plug this terminal into connector M, in location shown on sheet 1. Route the loose end to the RH Tail lamp and cut to length. Double this wire with the cut off portion, install terminal N and plug this terminal into connector F, in the location shown on sheet 1. Route the loose end to the right side marker, trim to length, install terminal P, and plug into lamp socket O.
H		BLACK	Side Marker Ground
J		YELLOW	LH Stop / Tail
K		DK GREEN	RH Stop / Tail
L		LIGHT GREEN	Back up lamp feed
M		WHITE	Courtesy ground
N			There are two loose black wires in this kit. Plug each into the rear side markers (connector O). Route the black wires to the rear panel support (near fuel tank filler) and attach to ground.
O			Route this wire to the LH tail lamp and cut to length and install terminal J. Plug this wire into connector F from above. Install terminal C and connector E on the tail lamp pigtail A, maintaining color continuity with connector F. Plug connector E into connector F.
P			Route this wire to the RH tail lamp and cut to length and install terminal J. Plug this wire into connector F from above. Install terminal C and connector E on the tail lamp pigtail A, maintaining color continuity with connector F. Plug connector E into connector F.
Q			Route this wire to the LH back up lamp, trim to length and install terminal N and connector H. Route the loose end of the lt green wire to the right side back up lamp. Repeat this procedure with terminal J. Install terminals C on each of the back up pigtails B, and plug into connectors H.
R			At the driver's side kick panel area, cut this wire, double it with the cut off portion using terminal D, and plug into connector E maintaining color continuity with the mating connector in the courtesy lamp kit (bag N). If you are using a dome lamp, route the loose end of this wire to the rear pillar area of the trunk, install terminal J and connector F. (Note: a factory dome lamp harness will also plug into this connector if you are not replacing the headliner at this time.) For a roof mounted single dome lamp, install the loose white wire S (supplied with terminal installed) into the dome lamp. Route this wire to connector F (on orange wire) location and trim to length. Install terminal C and connector E, maintaining color continuity with the white wire in connector F. If you are using dual sail panel dome lamps on a Camaro with Deluxe Interior, we have included a long loose white wire in this kit. Install terminal V onto one end of that wire, plug that terminal into one of the dual sail panel lamps and route that wire to connector F (on white wire) location and trim to length. Install terminal V onto the remainder of the cut off portion of the white wire, plug that terminal into the other dual sail panel lamp and route that wire to connector F (on white wire) location and trim to length. Double these wires together using terminal D and plug into connector E maintaining color continuity with connector F at the rear pillar area. Plug connector E into connector F to complete the dome lamp circuit.
S			At the driver's side kick panel area, cut this wire, double it with the cut off portion using terminal D, and plug into connector E maintaining color continuity with the mating connector in the courtesy lamp kit (bag N). If you are using a dome lamp, route the loose end of this wire to the rear pillar area of the trunk, install terminal J and connector F. (Note: a factory dome lamp harness will also plug into this connector if you are not replacing the headliner at this time.) For a roof mounted single dome lamp, install the loose orange wire S (supplied with terminal installed) into the dome lamp. Route this wire to connector F (on orange wire) location and trim to length. Install terminal C and connector E, maintaining color continuity with the orange wire in connector F. If you are using dual sail panel dome lamps on a Camaro with Deluxe Interior, we have included a long loose orange wire in this kit. Install terminal X onto one end of that wire, plug that terminal into one of the dual sail panel lamps and route that wire to connector F (on orange wire) location and trim to length. Install terminal X onto the remainder of the cut off portion of the orange wire, plug that terminal into the other dual sail panel lamp and route that wire to connector F (on orange wire) location and trim to length. Double these wires together using terminal D and plug into connector E maintaining color continuity with connector F at the rear pillar area. Plug connector E into connector F to complete the dome lamp circuit.
T			
U		DK BLUE	Fuel Pump
X			This wire can be used if you are using an electric fuel pump. Plug the terminated end into the 6 way power disconnect on the dash harness, maintaining color continuity with the dk blue wire in the mating connector. Route the other end to a fuel pump relay (not included in this kit, but available from American Autowire).

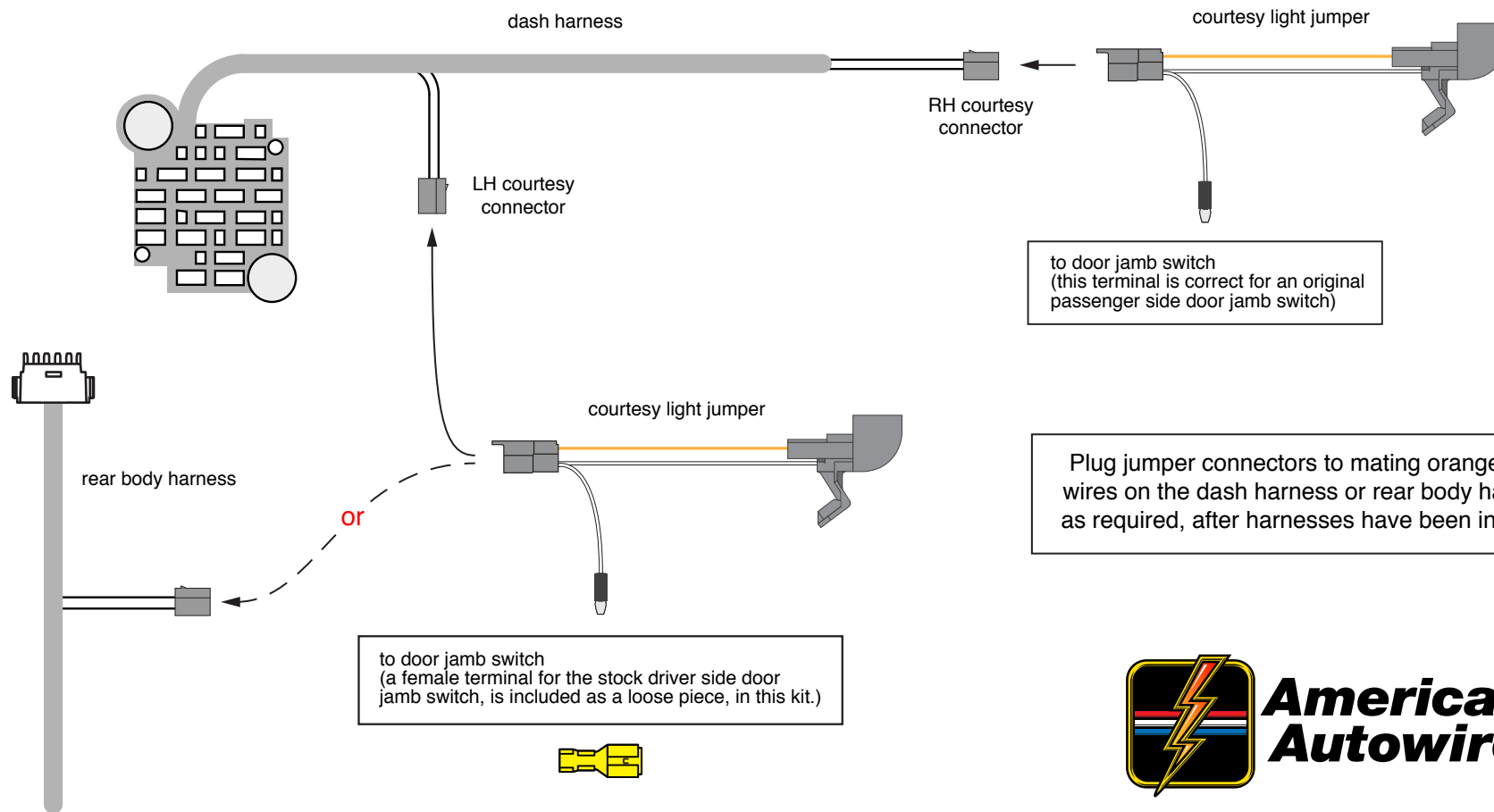

Plug jumper connectors to mating orange/white wires on the dash harness or rear body harness, as required, after harnesses have been installed.



**American
Autowire**

www.americanautowire.com 856-933-0801

NOTE: Your new underdash courtesy light kit uses # 631 bulbs (not included with this kit). They may be purchased at any auto parts store.

PART #

500708

N

DESCRIPTION:

Courtesy Light Kit

92966085

Rev 1.1

6/27/2016

REFER TO SHEETS 3 AND 4 FOR CONNECTING TO STOCK FACTORY CONSOLE GAUGES.
IF YOU ARE USING AFTERMARKET GAUGES, USE THE AFTERMARKET GAUGE CONNECTION TERMINALS (SEE 500663 BAG H).



1967 FACTORY CONSOLE GAUGE PACKAGE

For safety purposes, American Autowire does not support or encourage the use of a factory ammeter in an after-market application. A voltmeter is a much safer choice to monitor the charging system in a car equipped with a higher amperage alternator. American Auto manufactures factory type replacement voltmeters that are direct replacements for the stock ammeters for both the 1968-69 Camaro (510121) and the 1969-72 Nova (510122) console gauge packages. Contact our Sales Group or your favorite retailer today to purchase one of these gauges to complete your project.



1968-69 Camaro 1969-72 Nova FACTORY CONSOLE GAUGE PACKAGE



**American
Autowire**

www.americanautowire.com 856-933-0801

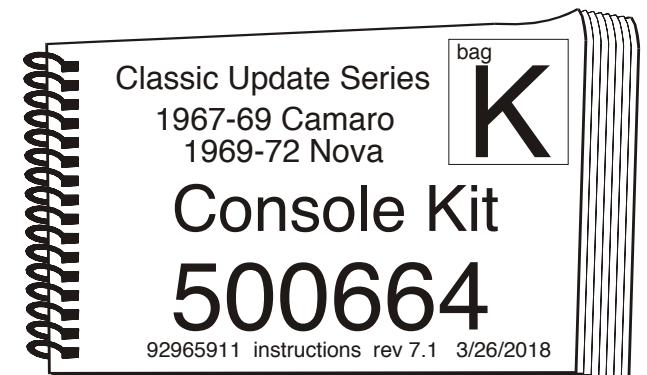

REFER TO SHEETS 3 AND 4 FOR CONNECTING TO STOCK FACTORY CONSOLE GAUGES.
 IF YOU ARE USING AFTERMARKET GAUGES, USE THE AFTERMARKET GAUGE CONNECTION TERMINALS (SEE 500663 BAG H).

CONNECTOR A

ORANGE 12v Ignition

Connect this wire to the courtesy lamp in the rear of the console (either location).
 Connect the shorter bare end wire to the console clock (if factory equipped).

WHITE Courtesy Ground

Note: If a console clock is not being used, this wire must be terminated and taped back against the harness to prevent and short to ground.
 Connect this wire to the courtesy lamp in the rear of the console (either location).

If you are using a console shift manual transmission, without gauges on the console, then only the orange and white wires will be used. All other applications, continue to the next wire.

CONNECTOR P

BLACK Ground

Route this wire to the console gauge plates and cut to length. Double this wire with the cut off portion, install terminal D.
 Connect the ring terminal to the gauge plate, as shown on sheet 3 for 1967 console gauges and sheet 4 for 1968-69 console gauges.
 For 1967 console gauges, connect the remaining black wire to the floor under the console using terminal as shown on sheet 3.
 For the 1968-69 console gauges, there are two gauge mounting plates that are mounted in a plastic tray. Both of these plates need to be grounded.
 In the stock configuration the second plate ground was on the inside of the tray connecting the two plates with a small ground jumper wire.
 If this wire is not on your gauge plates, you will need to create an additional ground wire to the second plate as shown on sheet 4. Then the remaining black wire is attached to the floor under the console using terminal Das shown on sheet 4.
 Using the butt splice connectors C, route the wires to each lamp location as shown on sheet 2. Install lamps socket G and rivets J and plug into the lamp holes on the gauge plates.

Note: If you have an automatic transmission, you will need to install the shift indicator lamps, as shown on sheet 2, using terminals F, J, springs H, and lamp sockets E.

LOOSE WIRES

PINK 12V Ignition

Plug this wire into connector B, maintaining color continuity with the mating connector on the dash harness.
 Route the other end to the temperature gauge, and cut to length. Double this wire with the cut off portion, and install terminal B. Route the remaining end to the fuel gauge, install terminal B, and plug into the fuel gauge in the location shown on sheet 2. (if using an electric oil pressure gauge, then double this wire and route to the oil gauge also) as shown on sheet 2.

TAN Fuel Sender

This wire is only used on an electric oil pressure gauge (not used on a factory mechanical pressure gauge).

DK BLUE Oil Pressure Sender

DK GREEN Temperature Sender

Plug this wire into connector B. Route this wire to the temperature gauge and cut to length. Install terminal B and connect to the sender (-) terminal.

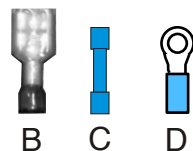

A, B & C are part of gauge terminal kit 92965220 found in bag H

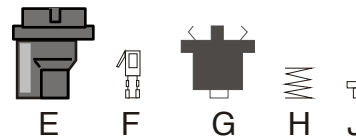

Look!

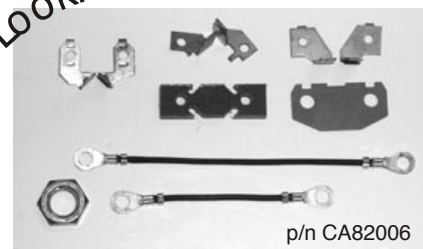

p/n CA82006

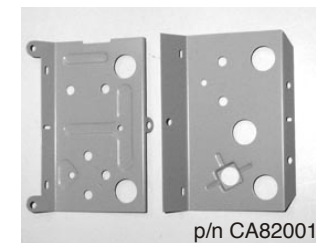

p/n CA82001

American Autowire manufactures OEM gauge terminals and OEM gauge plates for the 1968 & 1969 Camaros!

Classic Update Series

CONNECTING TO 1968-69 Camaro or 69-72 Nova FACTORY CONSOLE GAUGES

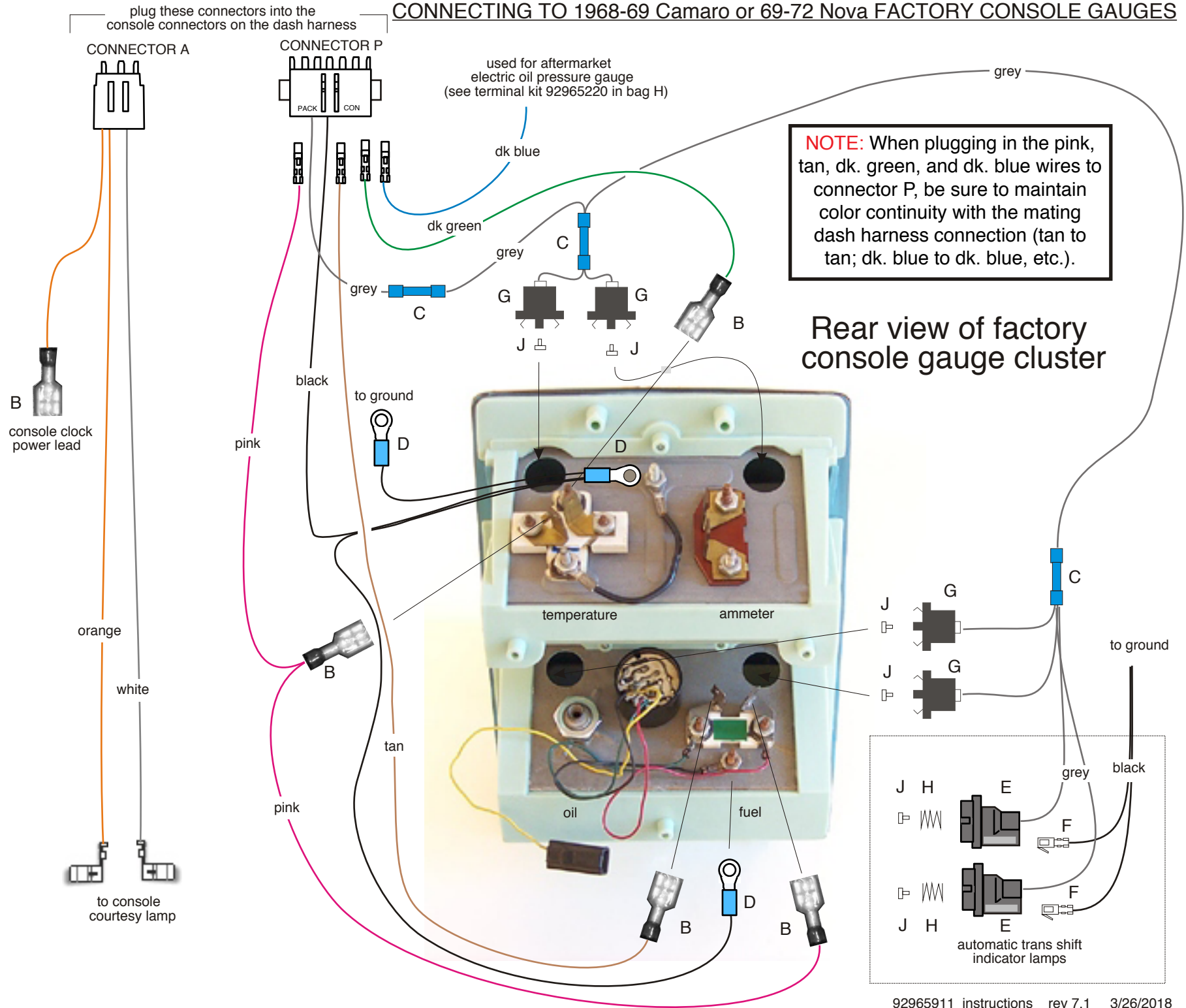

Most switches supplied with Classic Update and Universal Kits ship with the shaft pre-installed. In many instances, the switch can be installed without removing the shaft, but in some cases the switch shaft may need to be trimmed to fit your specific dash. In this situation, reference Trim to Fit instructions on the back of this page for details.

To install your new headlight switch:

1. Install the switch from behind the dash, and align the switch body with the mounting hole. The switch body has an alignment tab that must line up with the notch in the dashboard mounting hole.

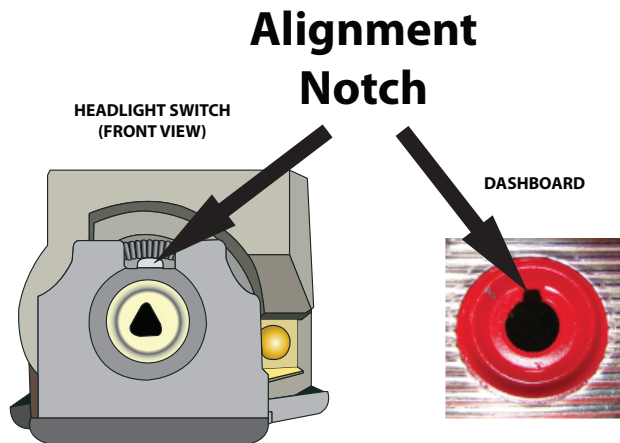

2. Install the switch mounting nut and tighten.

3. Gently press shaft into switch until it stops, then press firmly until it “clicks.” Pull shaft back out to confirm it is seated correctly. The shaft should be locked into place inside switch.

4. If the shaft does not lock, reinsert applying moderate pressure and slowly move shaft side to side for lock to engage. Make sure switch body is still supported to prevent flexing. Press shaft firmly until it clicks into place.

5. Ensure the shaft is fully seated and in the off position.

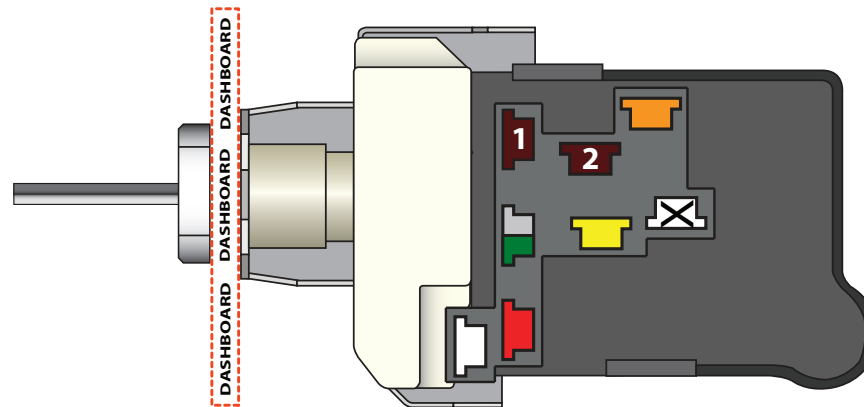

1	Parking Lights - Stay on with headlights
2	Tail Lights - On in the park and headlight positions
	Fused Battery Feed - For park, tail and dash lamps
	Headlight Feed - Power to the headlight dimmer switch
	12V Battery Feed - Unfused power to the switch for headlights
	Courtesy Ground - Ground feed to the dome and courtesy lights
	Part-Time Parking Lights - Turns off when the headlights are on (Not supported by all kits)
	OR Dash Lights - Output to the dash light fuse or lights



www.americanautowire.com 856-933-0801

PART #

500332

DESCRIPTION:

Headlight Switch

92964649 Rev 3.0 1/3/2020

To Trim Shaft to Fit or Remove Shaft:

The headlight shaft knob should extend from the face of the mounting nut, and must allow enough clearance for the switch to turn off. If the shaft is longer than necessary for your specific dash it can be trimmed to fit. Always trim the knob end of the shaft only and follow the guidelines below for best results.

1. With the headlight switch installed, loosen the set screw and remove the knob. Make sure the switch is in the "off" position by pushing the shaft toward the back of the switch.

Switch in OFF position
(shaft pushed all the way in)

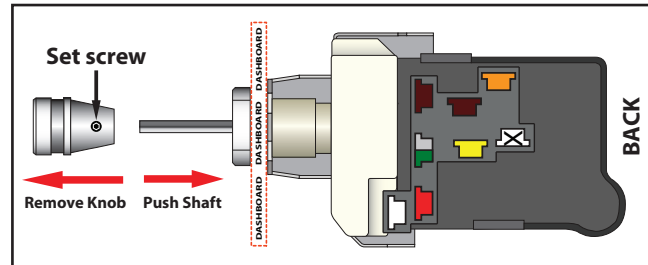

2. Set knob alongside shaft and mark the desired location for cutting on the shaft.

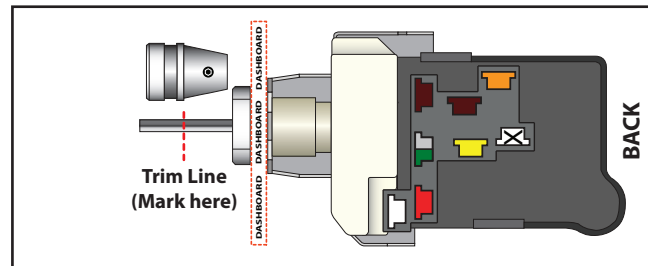

3. Remove the shaft and trim at mark. The shaft can be released from the switch by pulling it outward (toward the rear of the vehicle). Once fully in the "On" position, press and hold the release button on the base of the switch body. Once button is pressed, continue to pull the shaft outward. New switches may be tight, and it might be necessary to move the shaft side to side slightly while pulling to release.

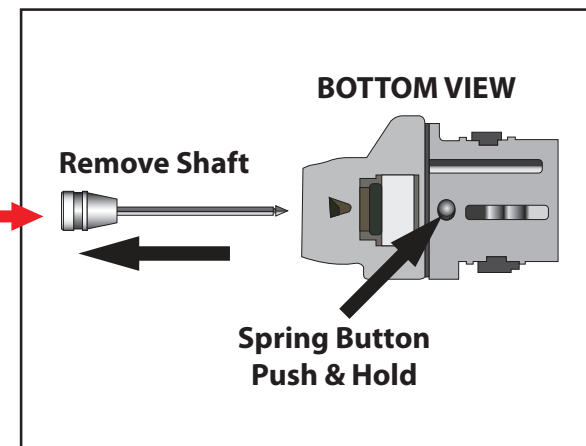
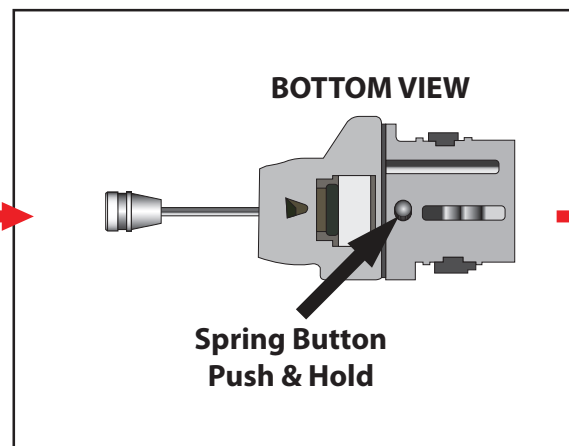
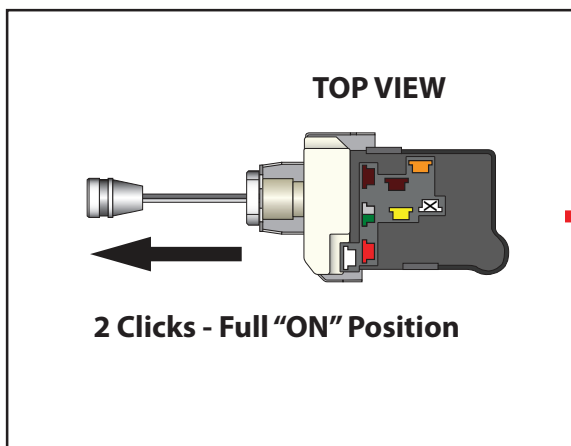

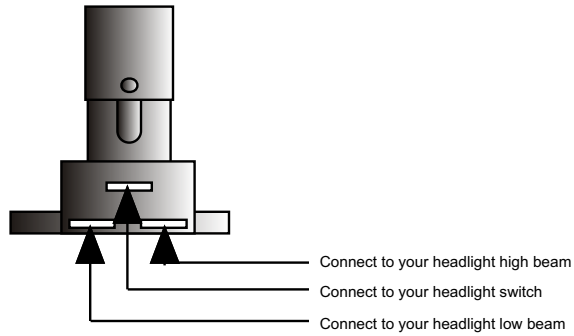

Connect the Dimmer Switch wires as shown above.

1. The top center terminal of the Dimmer Switch is connected to the Headlight switch.
2. The terminal on the right side is connected to your headlight high beam terminal.
3. The terminal on the left side is connected to your headlight low beam terminal.

another wiring product by...



150 Heller Pl #17 W Bellmawr, NJ 08031 856-933-0801

PART #

500042

DESCRIPTION:

DIMMER SWITCH

92964573 instruction sheet Rev 3.0 6/29/99

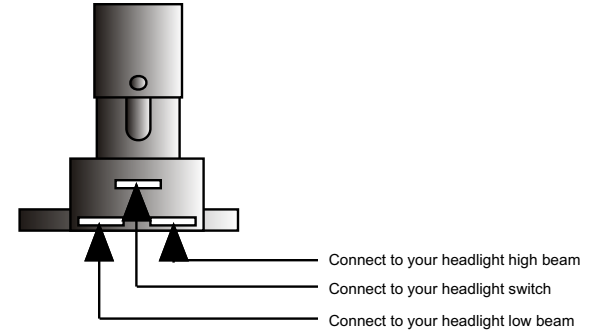

Connect the Dimmer Switch wires as shown above.

1. The top center terminal of the Dimmer Switch is connected to the Headlight switch.
2. The terminal on the right side is connected to your headlight high beam terminal.
3. The terminal on the left side is connected to your headlight low beam terminal.

another wiring product by...



150 Heller Pl #17 W Bellmawr, NJ 08031 856-933-0801

PART #

500042

DESCRIPTION:

DIMMER SWITCH

92964573 instruction sheet Rev 3.0 6/29/99