

NOTE: If the fuse panel on your 510105 70-72 Chevelle kit **DOES NOT** have a sticker like the photo at the left, you have the first design harness and your instructions are listed below and follow this page.

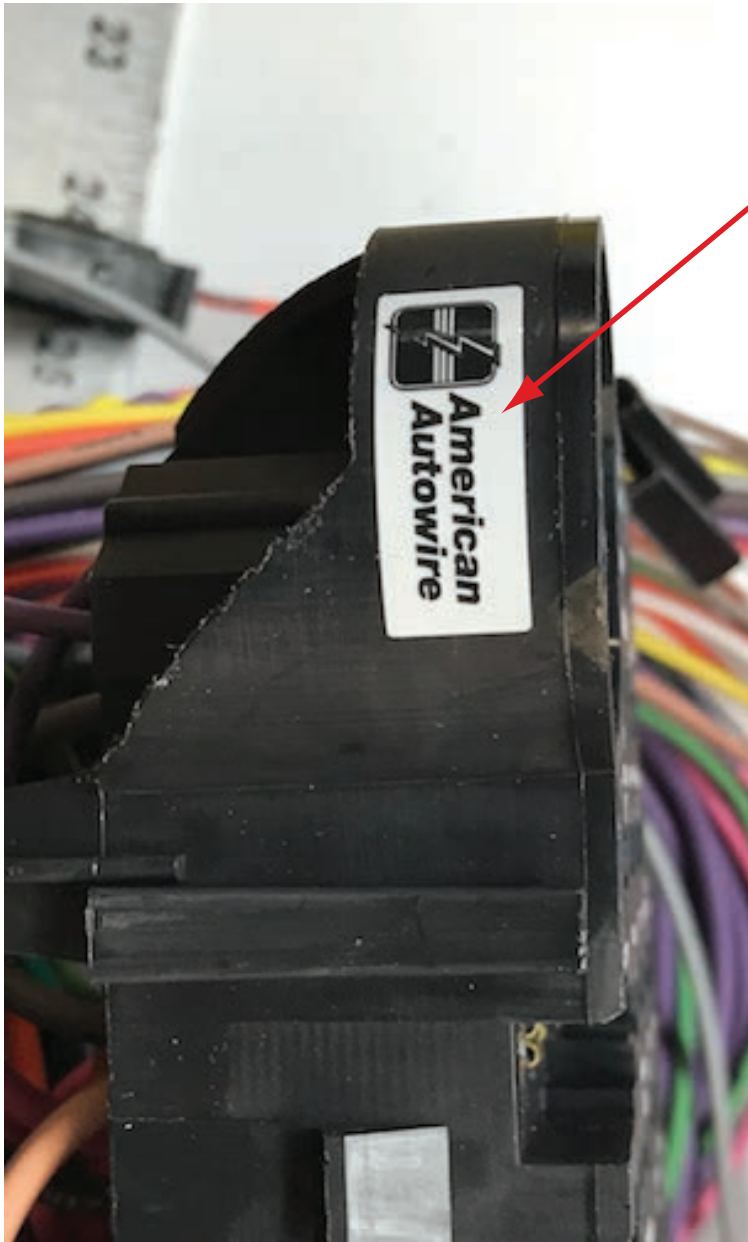

Number	Description
500332	Headlight Switch
500707	Fuse, Relay, and Flasher kit
500708	Courtesy Light kit
500919	Practice Terminal Crimping Set
510107	Dash Harness kit
510108	Engine Wiring Kit
510109	Front Light Wiring kit
510110	Instrument Cluster Wiring kit
510112	Console Wiring kit
510111	Rear Body Wiring kit
510476	Alternator and main power Connection kit
500042	Floor Dimmer Switch
92969162	Kit Introduction Instruction Sheet
92970010	Warning Sheet



www.americanautowire.com 856-933-0801

70-72 Chevelle
First Design
Instructions

92972884 rev. 0.0 2/12/2020



WARNING:

Validate the kit contents with the component list included on page 2 of this sheet before proceeding. This kit is intended to be used in a modified vehicle. Please read this sheet thoroughly and be sure that you understand everything explained on it prior to opening any of the enclosed packages, or before attempting to install any of the components. Once this kit has been opened or a component installed, the kit is not returnable.

1. This kit should typically be used in a **MODIFIED** application only.
2. This kit supports the use of factory heater systems and aftermarket heater and A/C systems. The kit supplies power to a factory A/C control head but **DOES NOT** include the actual A/C harness for an original factory A/C vehicle. Factory original A/C harnesses are available under our Factory Fit product line as they are self contained harnesses made to fit and work with the stock A/C component configuration.
3. This kit supports the use of a high current self-exciting 1-wire alternator or other style internally regulated alternators. An adapter may be necessary in some applications. The use of a stock, low amperage alternator is seriously discouraged as they cannot handle the higher current requirements of updated ignition systems, electric fans, aftermarket A/C systems, stereo systems, air ride suspensions, and other power hungry accessories and will ultimately create performance issues with the system.
4. This kit **WILL NOT** support the use of a factory ammeter. All AAW kits are engineered to supply the optimum charge to the battery. To achieve this performance, we route our 6ga. charge wire directly from the alternator output charge terminal to the starter battery terminal. Due to the path of the charge being altered from the stock configuration, the gauge can no longer see a charge vs. a discharge, so it will not work properly. When ammeters were originally used, most generator or alternator current outputs were rated at a maximum of about 25-60 amps. Modified cars being built today typically utilize a 100 amp or higher output alternator. With these higher current units, ammeters, generally speaking, become a safety hazard. Ammeters are usually wired in parallel to the charging circuit, are typically unfused, and can short very easily causing a fire. A voltmeter is recommended as a good alternative.
5. This kit **IS NOT** set up with a resistance wire for a standard, points type ignition system. It is wired with a full 12 volt primary ignition feed that is hot in the run position. Primary ignition voltage in the starting position is handled via a full 12 volt bypass wire. Our system will support HEI, MSD, other electronic ignition systems, as well as most all computerized Fuel Injection systems. If you wish to run a points type system, there are illustrations on the engine connection pages to do so. Extra parts (ballist resistor) that are not included in this kit will be required to complete that operation.



510105

510105 - Classic Update Series Kit 1970-72 Chevrolet Chevelle

This kit contains the following components:

<u>Bag</u>	<u>Part Number</u>	<u>Description</u>	<u>Quantity</u>
	500042	Floor Dimmer Switch	1
	500332	Headlight Switch	1
	500707	Fuse, Relay, and Flasher kit	1
N	500708	Courtesy Light kit	1
	500919	Practice Terminal Crimping Set	1
G	510107	Dash Harness kit	1
J	510108	Engine Wiring Kit	1
L	510109	Front Light Wiring kit	1
H	510110	Instrument Cluster wiring kit	1
M	510111	Rear Body Wiring kit	1
K	510112	Console Wiring kit	1
Z	510476	Alternator and Main Power Connection kit	1
	92969162	Kit Introduction Instruction Sheet	1
	92970010	Warning Sheet	1

Validate the kit contents with this component list. If there are any discrepancies with incorrect or missing parts, stop your installation and notify the supplier you purchased the kit from before proceeding.



www.americanautowire.com 856-933-0801

510105

Classic Update Series

1970-72 Chevelle

START HERE !

PLEASE READ THIS BEFORE STARTING INSTALLATION !

This wiring kit is designed for ease of installation. Please read the guidelines below, BEFORE STARTING your installation, to guarantee a successful job! Use an appropriate crimping tool which folds the crimp wings on the terminals as shown below. Top quality crimping tools are available from American Autowire or American Autowire authorized dealers.

NOTE: ALL TERMINALS THAT YOU INSTALL SHOULD BE PROPERLY SOLDERED.

Our factory terminations are installed by GM approved termination presses, and soldering is not necessary on these terminations.



STEP 1: DISCONNECT YOUR BATTERY:

Disconnect the battery before installing the wiring kit to prevent any accidental shorting caused by loose bare wire ends.

STEP 2: START INSTALLING KIT:

This kit is broken down into individual steps that are identified by a letter printed on the instruction sheets visible through each bag. These letters are the order of operation for installing your kit. Start with the bag letter G, then H, etc. The order of installation is shown below.

G 510107 Dash Harness Kit
H 510110 Instrument Cluster Kit
J 510108 Engine Kit
K 510112 Console Kit
L 510109 Front Light Kit
M 510111 Rear Body Kit
N 500708 Courtesy Light Kit
Z 510476 Alternator and Main Connection Kit

STEP 3: RECONNECT YOUR BATTERY:

When you have completed the installation and are ready to reconnect the battery, make sure that the following electrical system grounds are in place:

- A. Battery is grounded to the ENGINE BLOCK.
- B. Battery is grounded to the frame.
- C. Engine block is grounded to the frame.
- D. Body is grounded to the frame.

STEP 4: CHECK ALL ELECTRICAL FUNCTIONS:

Any non-functioning items should be checked for proper installation. Any problems with your wiring and electrical circuit functions should be addressed to American Autowire Systems, Inc. as soon as possible to avoid any warranty problems.

If you have any questions concerning this or any of our products, please feel free to call us at 1-800-482-WIRE.

We carry many accessories for your 1970-72 Chevelle

OEM style non-stick harness tape
p/n R0067108



OEM style turn signal switch.
p/n 01997938 (1970-72)



1970-72 OEM style wiper switches.
p/n 01993464 - without recessed park
p/n 01993465 - with recessed park

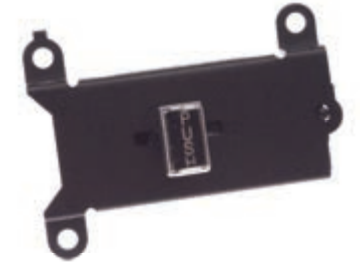

Muncie 4 speed back up lamp switch.
p/n 03943657 (1970-72)



OEM large terminal and double
crimping tool (12-8 gauge).
p/n 500523



Multi-crimp tool (20-14 gauge).
p/n 500649



Breakerless Ignition Module,
GM V-8 POINT CONVERSION KIT
p/n 38131



Factory assembly manuals.
(It's what they used on the assembly
line to build your Camaro!)

p/n 36300 (1970)
p/n 36301 (1971)
p/n 36302 (1972)



American Autowire / Factory-Fit
800-482-9473

AMERICAN AUTOWIRE MAKES IT EASY !!

Classic Update Series

1970-72 Chevelle

510105

© COPYRIGHT 2004 American Autowire
Used with express permission of
American Autowire / Factory-Fit
92969162 instruction sheet rev. 2.0 2/1/2018

Classic Update Series

1970 Chevelle



American Autowire / Factory-Fit
800-482-9473

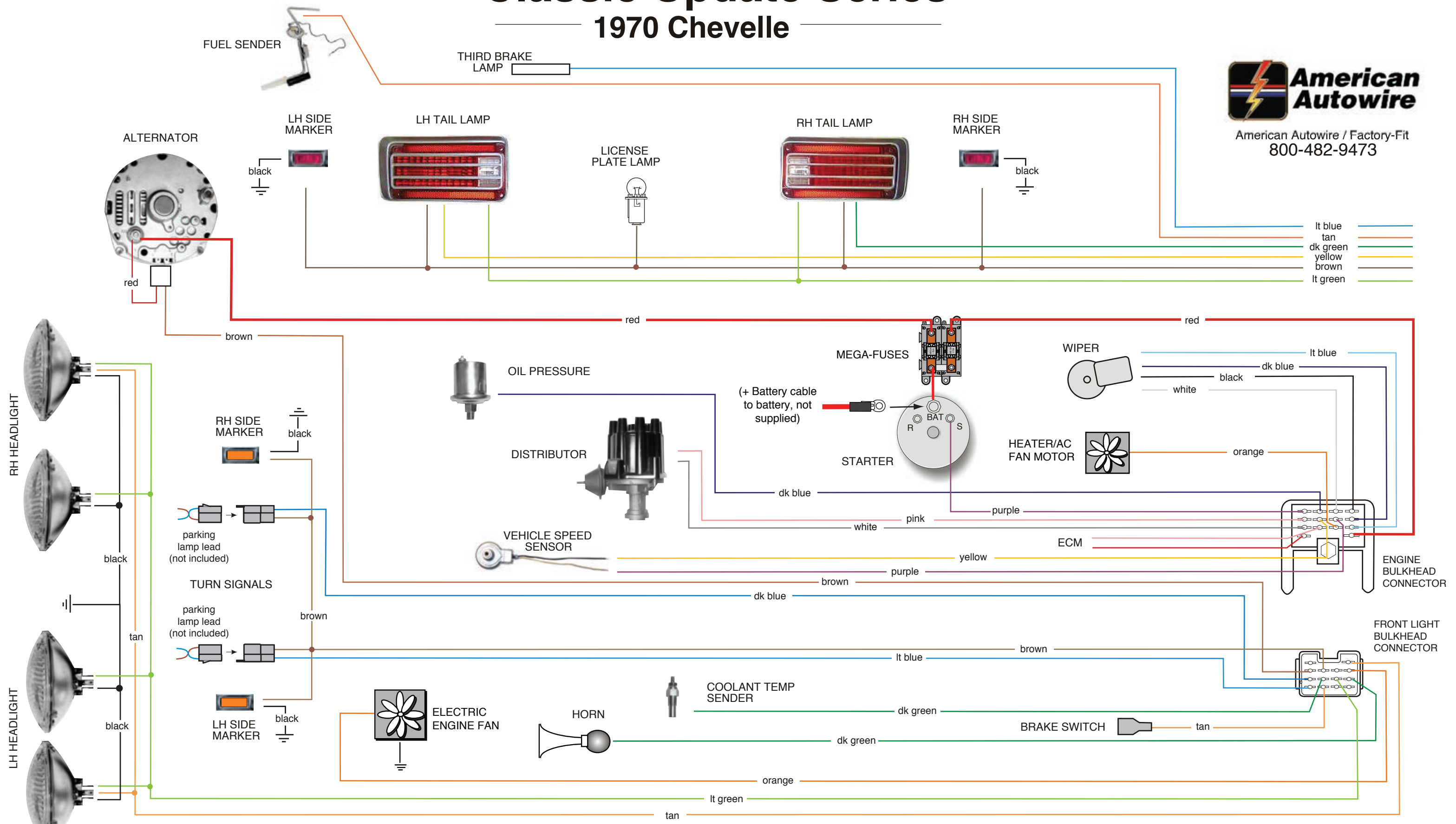

- lt blue
- tan
- dk green
- yellow
- brown
- lt green

NOTICE: This schematic drawing is for reference only.
Do not use the schematic to install this wiring kit!
Use the instruction sheets included in each bag, which includes directions for proper terminations.

510105

© COPYRIGHT 2004 American Autowire
Used with express permission of American Autowire
92969162 instruction sheet rev. 2.0 2/1/2018

Classic Update Series

1971-72 Chevelle



American Autowire
800-482-9473

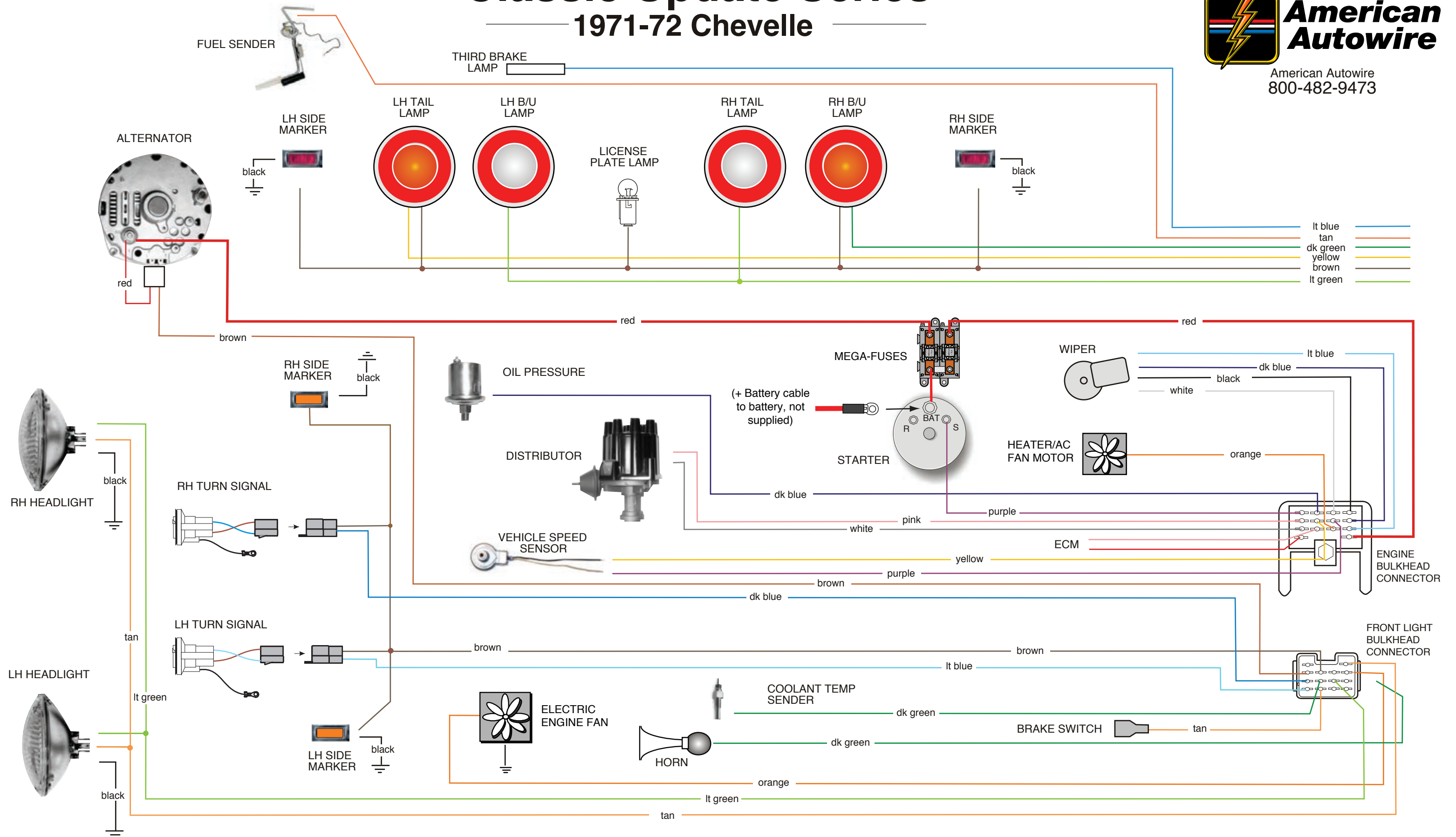

NOTICE: This schematic drawing is for reference only.
Do not use the schematic to install this wiring kit!
Use the instruction sheets included in each bag, which includes directions for proper terminations.

510105

© COPYRIGHT 2004 American Autowire
Used with express permission of American Autowire
92969162 instruction sheet rev. 2.0 2/1/2018



American Autowire
800-482-9473

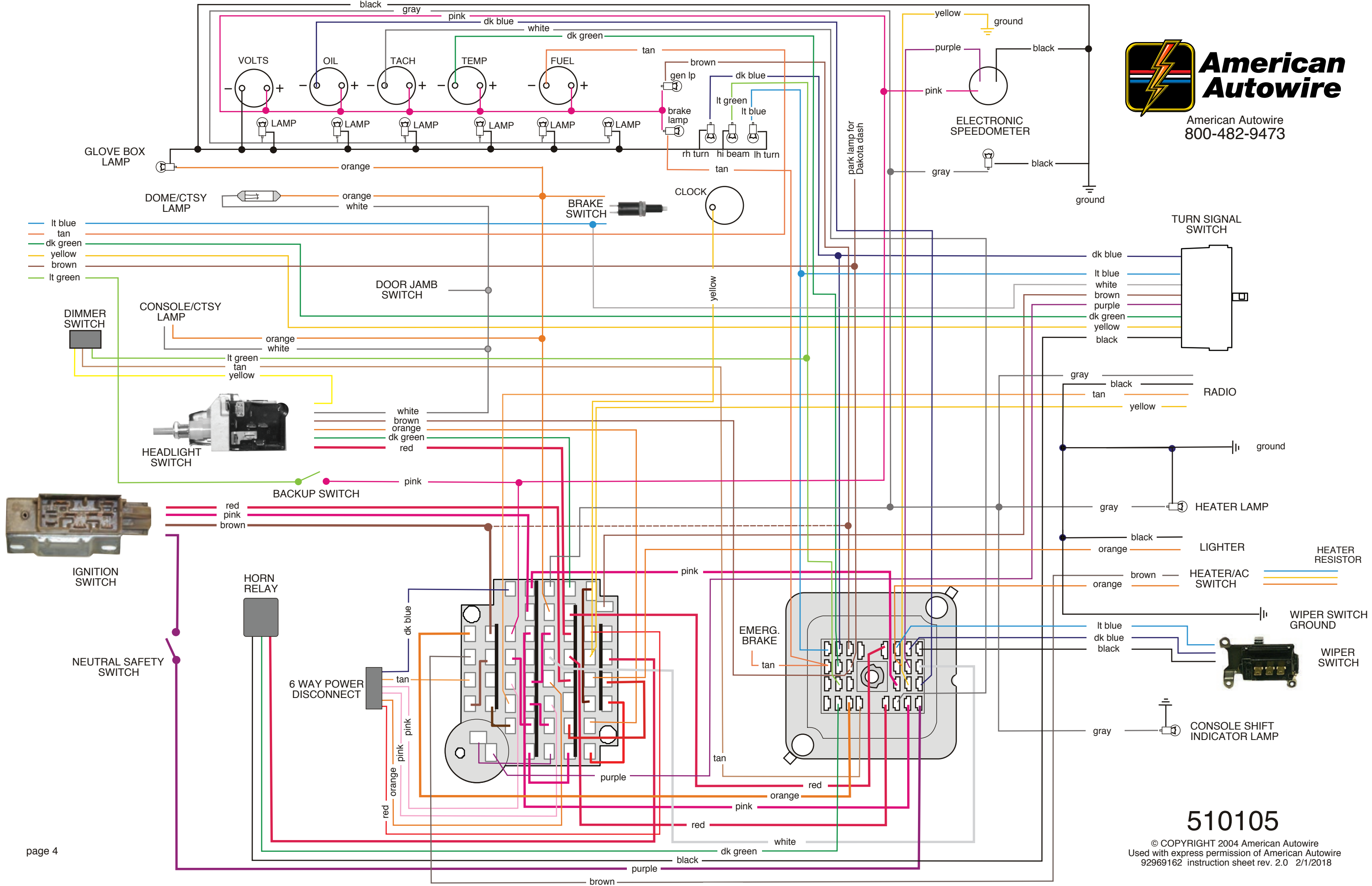

510105

© COPYRIGHT 2004 American Autowire
Used with express permission of American Autowire
92969162 instruction sheet rev. 2.0 2/1/2018

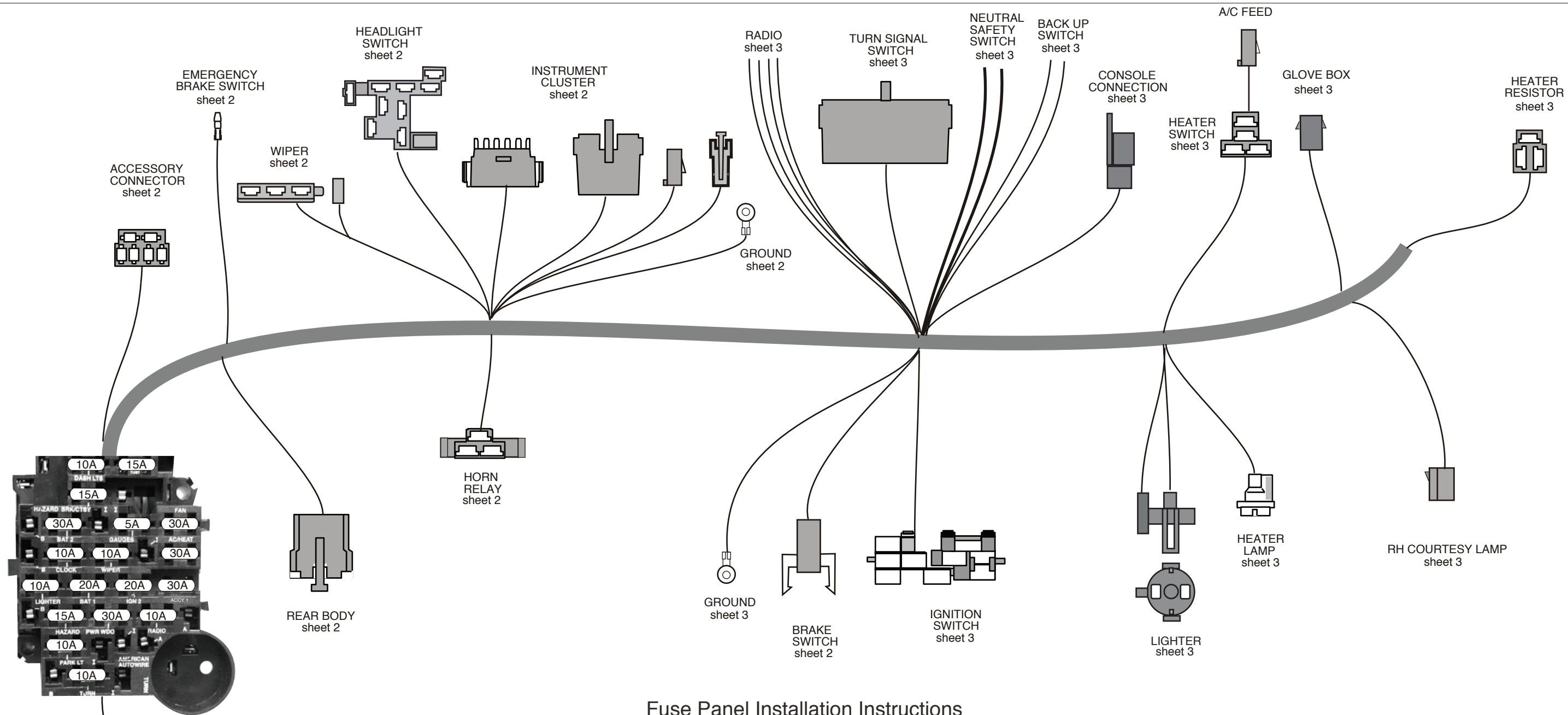

The above picture shows the orientation for 72 Chevelle wiper hook-up only. All other applications can only be plugged in one way.

Fuse Panel Installation Instructions

Following these simple instructions will guarantee a successful installation of your American Autowire fuse panel harness.

1. Study the diagram above to familiarize yourself with the dash harness.
2. Install the fuse box.
3. Route the dash harness using the factory support straps.
4. Make all connections as shown on the following pages of this dash harness kit.
5. Once this harness is installed, continue to bag 'H', and install the rest of the kit (bags H,J,K,L,M).



www.americanautowire.com 856-933-0801



INSTALLING THE FUSE BOX

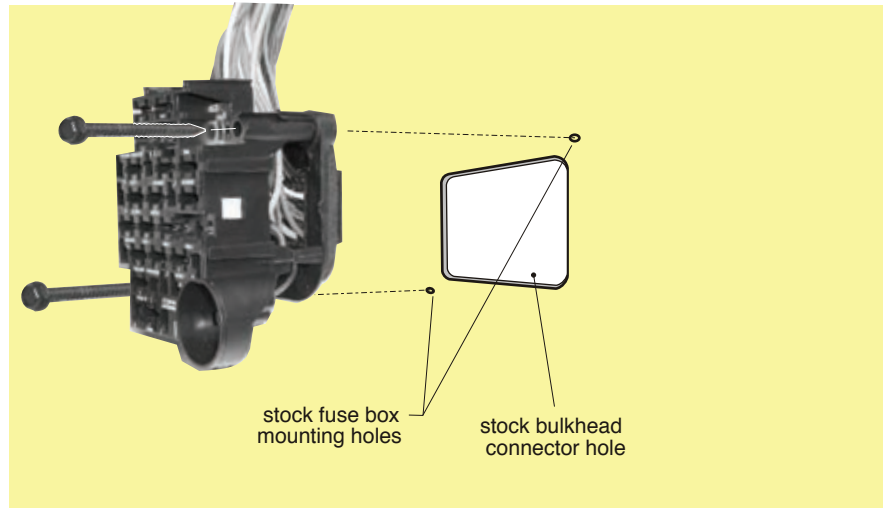

1. Locate the stock OEM bulkhead hole in the driver side of the firewall.
2. Mount the fuse box with the flasher can in the bottom right corner, as shown above.
3. Using the two mounting screws A, attached the fuse panel to the firewall.

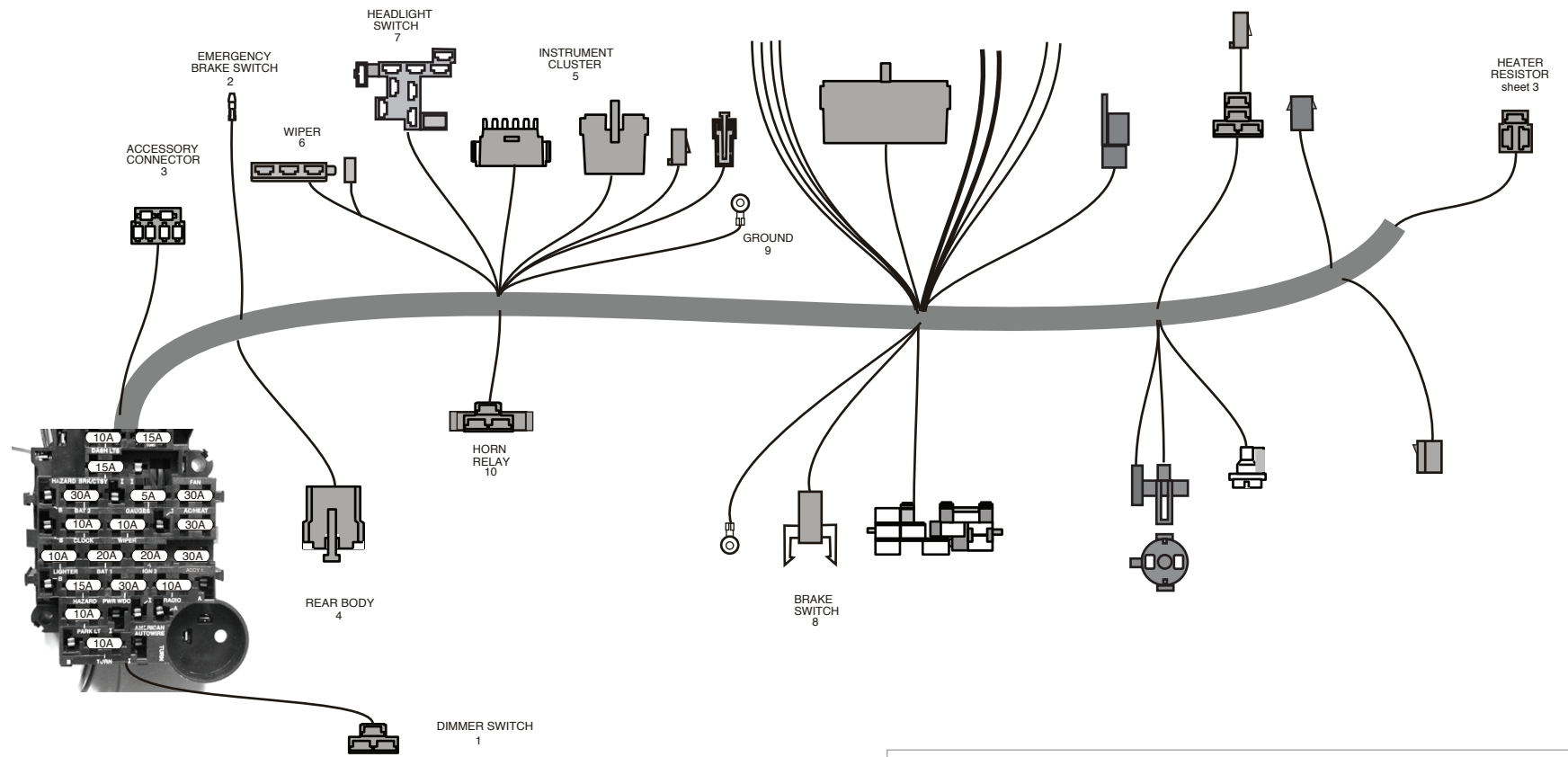

1	DIMMER SWITCH	Light Green Light Green Tan Yellow	Thin wire is feed to high beam indicator light in instrument cluster Heavy wire is headlight high beam feed wire. Headlight low beam feed wire. Headlight power feed wire from headlight switch.
2	EMERGENCY BRAKE	Tan	Connect to the emergency brake switch. This is the ground circuit for the brake switch light.
3	ACCESSORIES		Use the provided connector J and terminals as power leads for the following:
		Fuse Rating	
		Tan FUEL 10 amp	Fused 12 volt IGNITION feed for fuel pump (may also be used to feed power to another ignition circuit)
		Orange BAT1 20 amp	Fused 12 volt BATTERY feed for power seats (may also be used to feed power to another battery circuit)
		Red BAT2 30 amp	Fused 12 volt BATTERY feed for power door locks (may also be used to feed power to another accessory circuit)
		Pink IGN1 20 amp	Fused 12 volt IGNITION feed for cruise control (may also be used to feed power to another ignition circuit)
		Pink PWRWDO 30 amp	Fused 12 volt IGNITION feed for power windows (may also be used to feed power to another ignition circuit)
		Dk Blue ACCY1 30 amp	Fused 12 volt ACCESSORY feed (may also be used to feed power to an accessory circuit)
4	REAR BODY		This connector will mate to the connector from the Rear Body harness found in bag L.
		Tan	Fuel tank sender lead
		Brown	Tail lamp feed
		Yellow	LH turn / brake feed
		Dark Green	RH turn / brake feed
		Orange	Dome / courtesy lamp feed
		White	Dome / courtesy lamp ground
		Light Green	Back up lamp feed
		Light Blue	Third brake light
5	INSTRUMENT CLUSTER DISCONNECTS		These connectors will plug into the gauge disconnect harness 510112, bag H. Wire identifications are described on the Instruction sheets in bag H.
6	WIPER	Black Black Dk Blue Lt Blue	Ground for switch assy. (single connector used in 72 Chevelle only) Ground circuit for low speed. (in 3 way connector) Ground circuit for washer. (in 3 way connector) Ground circuit for hi speed. (in 3 way connector)
7	HEADLIGHT SWITCH	Red Orange Brown Yellow Dk Green White Black	12 volt feed to switch BAT location on headlight switch 12 volt lead in to Park/tail PARK / TAIL feed in location on headlight switch. (commonly found on GM headlight switches). Park lamp feed out PARK LAMP OUT location on headlight switch. Dimmer feed DIMMER FEED location on headlight switch. Instrument lamp feed INSTRUMENT LAMP location on headlight switch. Dome / courtesy ground COURTESY GROUND location on headlight switch. Switch body ground GROUND for switch assembly
8	BRAKE SWITCH	Orange White Lt Blue Black	Plug this connector into the factory stop lamp switch. 12 volt feed 'in' to switch. 12 volt brake feed 'out' to steering column turn signal switch. 12 volt brake feed 'out' to third brake light. Connect to a good chassis ground.
9	GROUND	Black	Plug the horn relay (found in the fuse bag) into this connector.
10	HORN RELAY	Red Black Green	12 volt battery Relay ground circuit (to steering column) Triggered 12 volts to horn

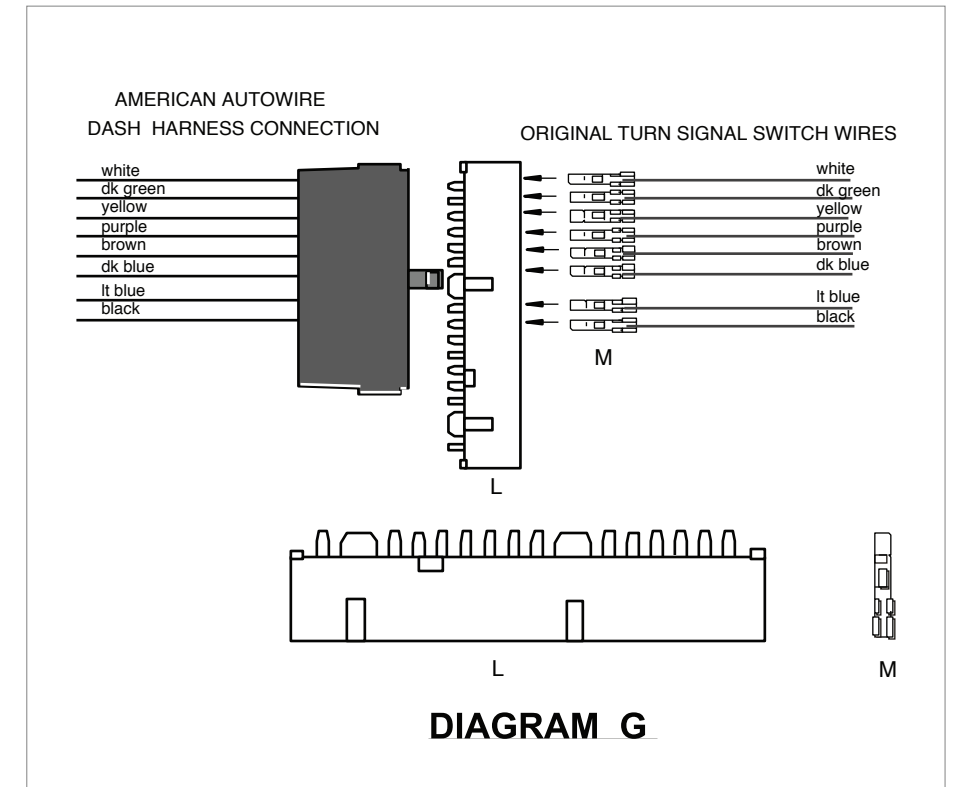

www.americanautowire.com 856-933-0801

1970-72 Chevelle
DASH KIT
510107

92969165 instruction rev 1.0 7/18/2014

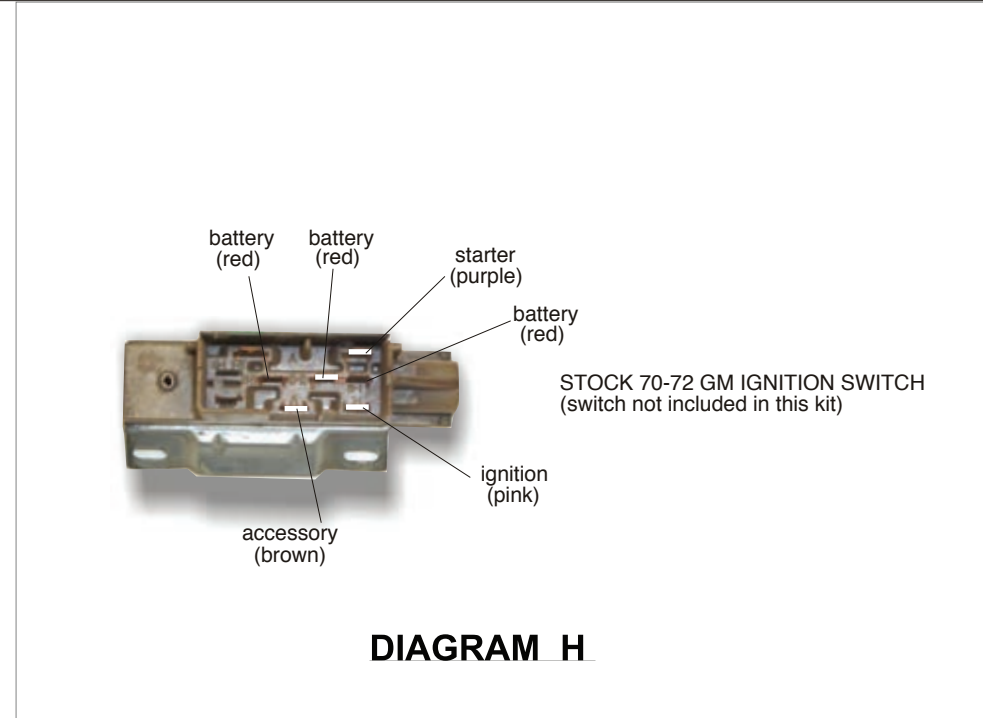
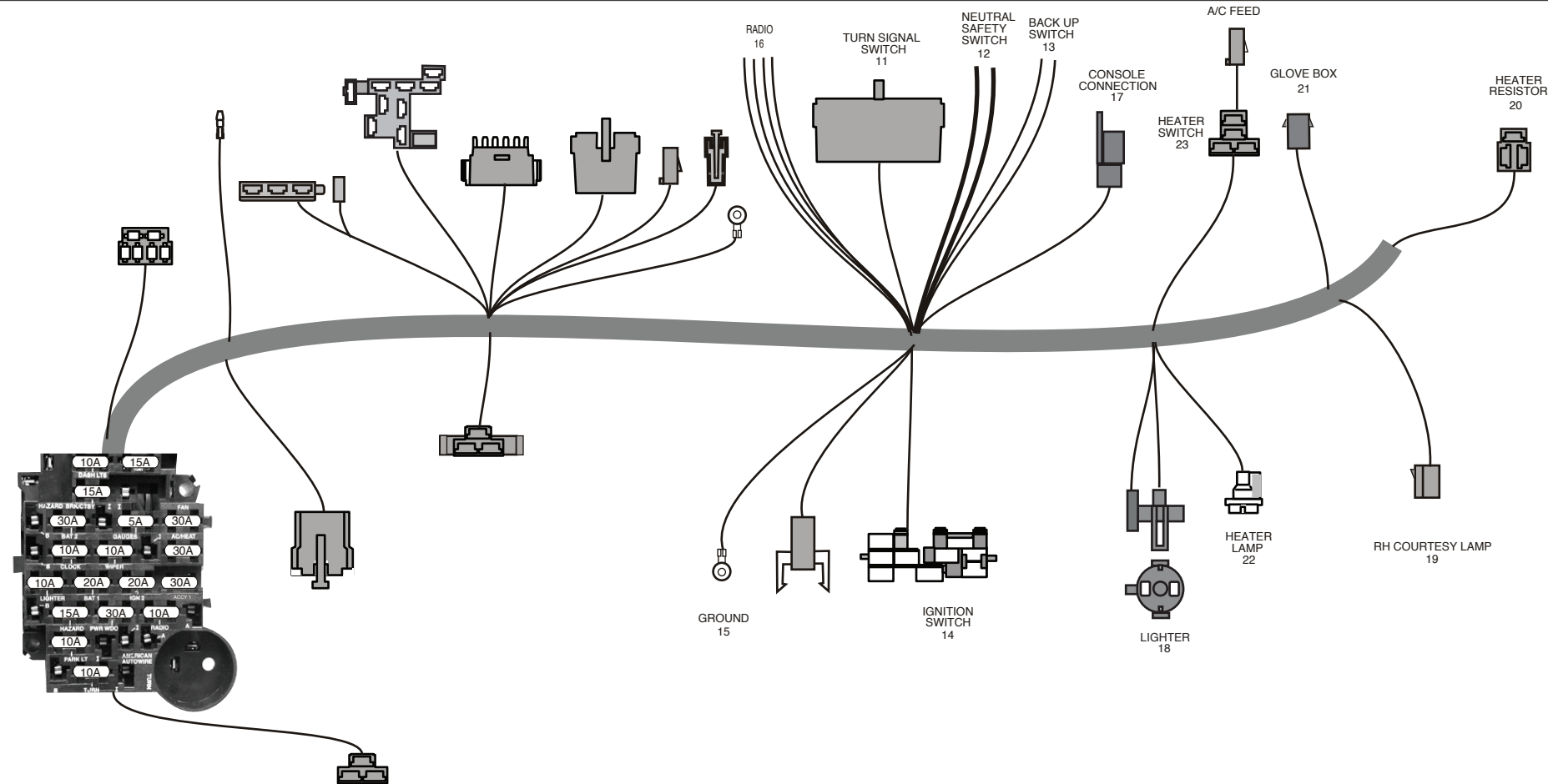

DIAGRAM H

11	TURN SIGNAL SWITCH	White Dark Green Yellow Purple Brown Dark Blue Light Blue Black	This harness has a connector on it for the 3 7/8 in. 1969-74 GM steering column connection used by GM and many after-market manufacturers. If using a late model GM steering column or an aftermarket column using the 4 1/4 in. GM turn signal connector, replace existing connector with connector "L" being sure to match wires by color. (See Diagram G on sheet 2 if needed) 12 volt feed from brake switch RH tail lamp LH tail lamp 12 volt feed from turn flasher 12 volt feed from hazard flasher RH front park lamp LH front park lamp Horn relay ground wire to horn switch Connect these wires to the neutral safety switch on the column or console shifter.
12	NEUTRAL SAFETY SWITCH	Purple Purple	12 volt feed 'in' to neutral safety switch from ignition switch. 12 volt feed 'out' to starter solenoid.
13	BACK UP SWITCH	Pink Lt Green	Connect these wires to the back up switch on the column or console shifter. 12 volt ignition feed 'in' to back up lamp switch 12 volt feed 'out' to back up lamps
14	IGNITION SWITCH	Red Pink Brown Purple Black	Note: Connectors are already plugged in if you are using a stock 1970-72 ignition switch as shown in Diagram H. 12 volt battery feed 12 volt ignition feed 12 volt accessory feed Starter lead wire to Neutral Safety Switch Connect to a good chassis ground.
15	GROUND	Black	
16	RADIO	Tan Yellow	Radio accessory feed. (Power wire for stock radio). Black wire for radio ground. Gray wire for radio lamp. Radio constant 12 volt clock or memory lead (battery feed)
17	CONSOLE CONNECTION		These wires are for use on a console vehicle. For wire functions, refer to bag K, 510112.
18	LIGHTER	Orange	Connect to lighter. (battery and ground feeds)
19	RH COURTESY LAMP	Orange White	Plug this connector into the mating connector from the courtesy lamp kit bag N, 500708. 12 volt battery feed fo lamp Ground circuit for lamp
20	HEATER RESISTOR		Plug this connector into the factory heater resistor located on top of the heater box on most A/C cars.
21	GLOVE BOX LIGHT	Orange	Connect to the original factory glove box lamp switch. If not using, just unplug and tape back.
22	HEATER LAMP	Gray	Heater lamp
23	HEATER SWITCH	Brown	Plug this connector into the factory heater switch. 12 volt accessory feed to heater / ac switch (if using aftermarket a/c, use the short brown wire as the accessory feed wire to a/c harness. If a new factory A/C harness is needed, please contact our Sales Department for the proper application for your car)
		Yellow Lt Blue Orange	Heater resistor Heater resistor Heater resistor



1970-72 Chevelle
DASH KIT
510107

THIS PAGE HAS BEEN
INTENTIONALLY LEFT BLANK



1970-72 Chevelle
DASH KIT
510107

Classic Update Series

REFER TO SHEET 2 FOR CONNECTING TO A STOCK INSTRUMENT CLUSTER. IF USING A FACTORY DASH CIRCUIT BOARD, BE SURE TO INSTALL THE WIRES AS SHOWN FOR WARNING LIGHTS OR FACTORY GAUGES. THIS AAW KIT DOES NOT SUPPORT THE USE OF A FACTORY AMMETER. WE SUGGEST THE USE OF A VOLTMETER INSTEAD. IF YOUR CAR HAS AN ORIGINAL SWEEP DASH, YOU WILL NEED TO SPLICE THE CLUSTER WIRES FROM THIS KIT INTO YOUR ORIGINAL WARNING LAMP PODS MAINTAINING COLOR CONTINUITY BETWEEN THE TWO. IF YOU ARE USING AFTERMARKET GAUGES, TERMINAL KIT 92965220 HAS BEEN PROVIDED TO CONNECT THIS CLUSTER KIT TO YOUR GAUGES.

CONNECTOR F - Plug this connector into the mating connector on the dash harness (bag G) and connect wires as follows:

Wire Color	Function	Stock circuit board connection
DK BLUE	Right Turn Lamp	Route this wire to the circuit board and cut to length. Install terminal A, and plug into connector B in the location shown on sheet 2.
LT BLUE	Left Turn Lamp	Route this wire to the circuit board and cut to length. Install terminal A, and plug into connector B in the location shown on sheet 2.
LT GREEN	Hi Beam Lamp	Route this wire to the circuit board and cut to length. Install terminal A, and plug into connector B in the location shown on sheet 2.
DK GREEN	Temperature Sender	Route this wire to the circuit board and cut to length. Install terminal A, and plug into connector B in the location shown on sheet 2.
DK BLUE	Oil Pressure Sender	Route this wire to the circuit board and cut to length. Install terminal A, and plug into connector B in the location shown on sheet 2.
TAN	Fuel Sender	Route this wire to the circuit board and cut to length. Install terminal A, and plug into connector B in the location shown on sheet 2.
TAN	Brake Lamp	Route this wire to the circuit board and cut to length. Install terminal A, and plug into connector B in the location shown on sheet 2.

CONNECTOR G - Plug this connector into the mating connector on the dash harness (bag G) and connect wires as follows:

Wire Color	Function	Stock circuit board connection
PINK	12v Ignition	Route this wire to the circuit board and cut to length. Install terminal A, and plug into connector B in the location shown on sheet 2.
GREY	Instrument Lamps	Route this wire to the circuit board and cut to length. Install terminal A, and plug into connector B in the location shown on sheet 2.
BLACK	Ground	Route this wire to the circuit board and cut to length. Install terminal C, and attach this wire to the back of the stock gauge cluster assembly.

CONNECTOR H - Plug this connector into the mating connector on the dash harness (bag G) and connect wires as follows:

Wire Color	Function	Stock circuit board connection
PURPLE	VSS signal	Not used in stock configuration. Used ONLY with an electronic speedometer. This wire will plug into connector H, maintaining color continuity with the purple wire on the mating dash connector. Connect the other end to the speedometer 'sender' terminal following the manufacturer's instructions.
YELLOW	VSS ground	Not used in stock configuration. Used ONLY with an electronic speedometer. This wire will plug into connector H, maintaining color continuity with the yellow wire on the mating dash connector. Connect the other end with the ring terminal to a good chassis ground following the manufacturer's instructions.

LOOSE WIRES

WHITE	Tachometer	Used ONLY with a tachometer. Plug this loose wire into connector F, maintaining color continuity with the white "TACH" wire on the mating dash connector. Route the other end of this wire to the circuit board and cut to length. Install terminal A, and plug into connector B in the location shown on sheet 2.
BROWN	Alternator	Used with a stock alternator lamp. Plug this loose wire into connector F, maintaining color continuity with the brown "ALT" wire on the mating dash connector. Route the other end of this wire to the circuit board and cut to length. Install terminal A, and plug into connector B in the location shown on sheet 2.
BROWN	Park Lamp	Used ONLY with Dakota Digital dash panels. Plug this wire into connector G, maintaining color continuity with the brown "PARK LAMP" wire on the mating dash connector. Connect the other end to the gauge manufacturer's panel - 'DIM' location. This will dim the panel lights when headlights are turned on.

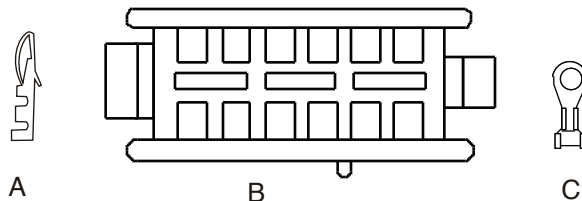

**American
Autowire**

www.americanautowire.com 856-933-0801

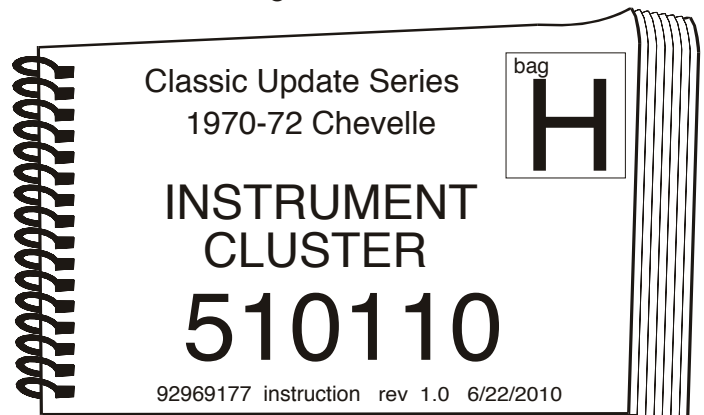

Classic Update Series
1970-72 Chevelle

bag
H

INSTRUMENT
CLUSTER

510110

92969177 instruction rev 1.0 6/22/2010

USE THIS SHEET TO CONNECT TO AN ORIGINAL 1970-72 CHEVELLE
FACTORY INSTRUMENT CLUSTER WITH A CIRCUIT BOARD CONNECTION

Classic Update Series

CIRCUIT BOARD CONNECTOR
WITH WARNING LIGHTS

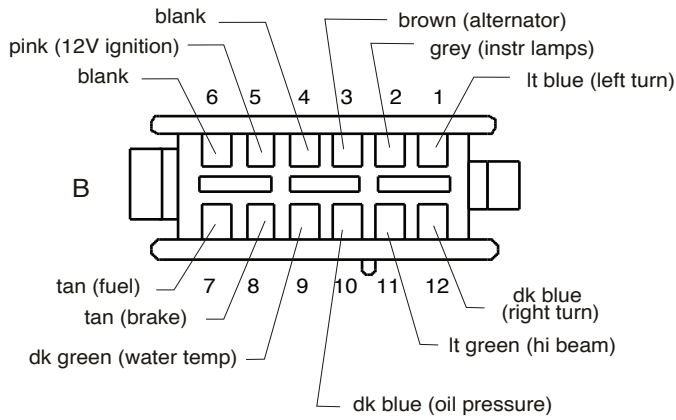

CIRCUIT BOARD CONNECTOR
WITH GAUGES

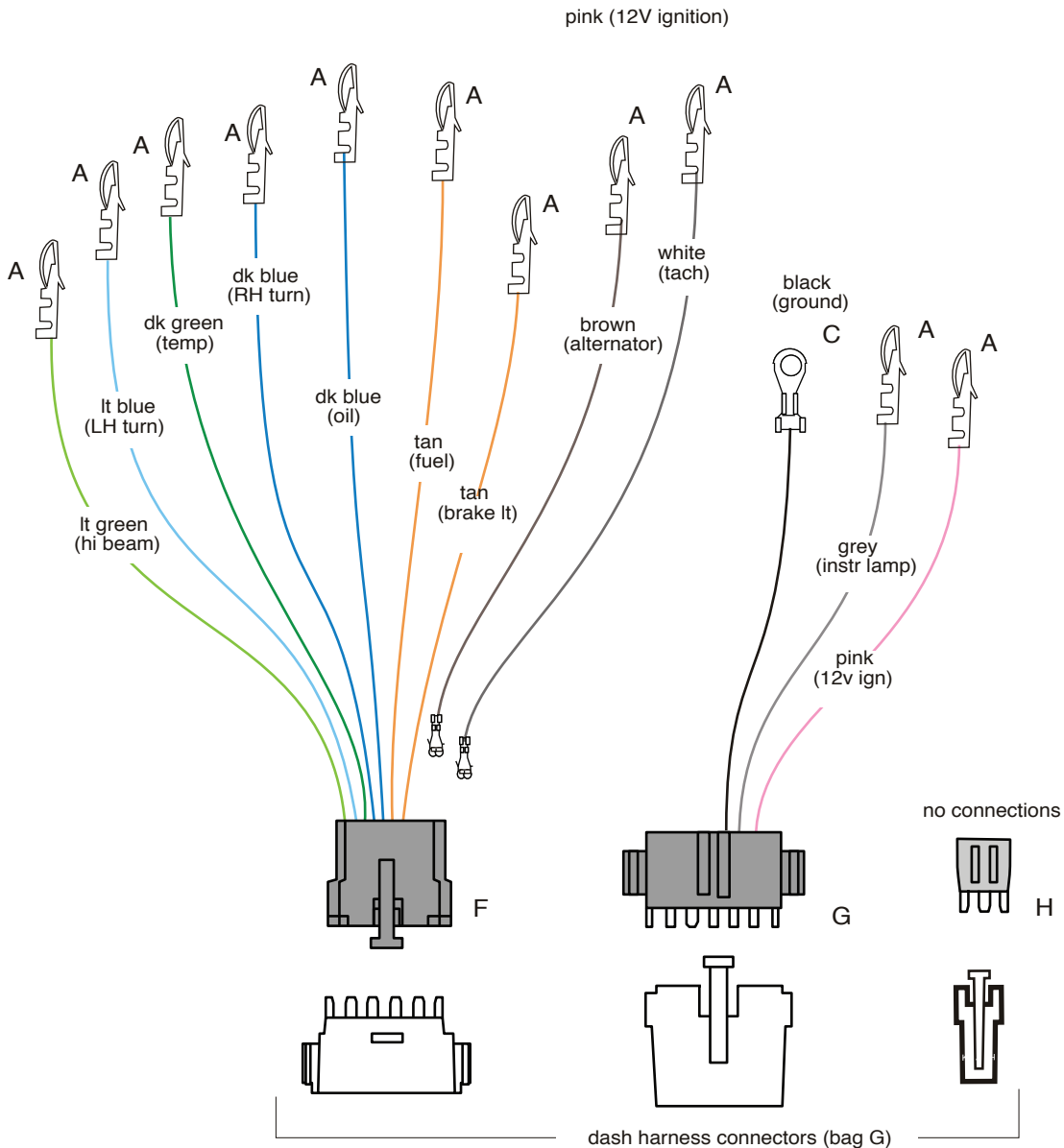
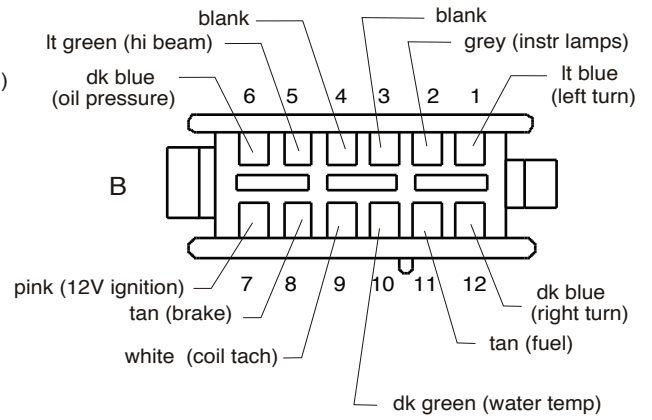

Classic Update Series

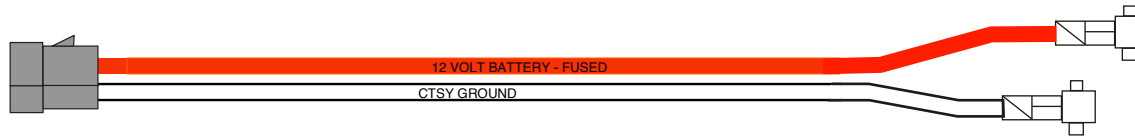

Console Rear Courtesy
Lamp Extension
(All Applications)



Automatic Transmission
Console Shifter Light
Harness (uses 1895 bulbs)



A



B



Automatic Transmission
Console Neutral Safety
Switch Extension

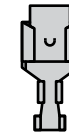

C

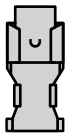

D

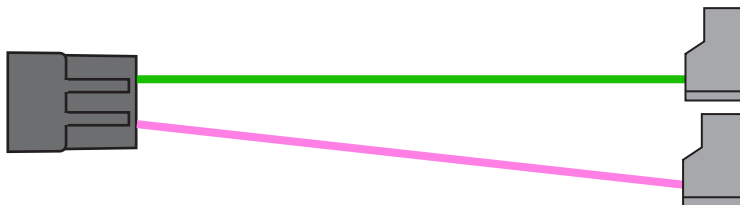

Automatic Transmission
Console Back Up Lamp
Switch Extension



**American
Autowire**

www.americanautowire.com 856-933-0801

NOTE: In this kit, you will find:

1. All the necessary extension harnesses, terminals, and connectors that are required to complete the installation of your factory console to your new AAW dash harness.
2. All the necessary terminals, and connectors that are required to connect the NSS and Back Up lamp wires found at locations 12 and 13 on page 3 of your dash harness (510107 for 1970-72 or 510160 for 1968-69) instructions to your column mounted NSS/ Back up lamp switch (Automatic on the column), or clutch mounted NSS and column mounted back up lamp switch (Manual transmission).
3. Simply follow the assembly directions on page 2 of this instruction set.

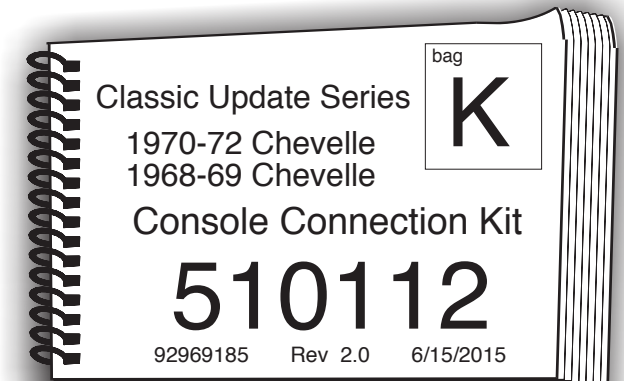

INSTALLATION DIRECTIONS

For Manual Transmission cars.

Console Courtesy lamp:

1. Plug this console rear lamp extension into the mating connector at location 17 on page 3 on your dash harness (510107 for 1970-72 or 510160 for 1968-69) instructions. Snap the lamp socket terminals into the original location at the back end of your console, then install your bulb (**not included**).

NSS and back up lamp switch connections:

2. Route the NSS and Back Up lamp wires found at locations 12 and 13 on page 3 of your dash harness (510107 for 1970-72 or 510160 for 1968-69) down to the base of the steering column near the firewall, and trim them to length.
3. For 1968 applications that did not use a NSS for manually shifted cars, you will need to connect these 2 purple wires together in order for the car to start. For 1969-72 applications that utilized a clutch pedal operated NSS, crimp terminals D onto the trimmed purple NSS dash wires, plug them into connector B, then plug this completed connection into your original clutch operated NSS extension (**not included in this kit**).
4. For 1968 applications that utilized a transmission mounted back up lamp switch, there should be a jumper harness with a rubber grommet molded onto one end of it that is snapped into your firewall with a 2-position male connector on the opposite end. If you are missing this harness and switch, they may be purchased separately (CA70554 - harness; 01993307 - switch) from AAW. Take the light green and pink back up lamp wires from step 2 above, crimp terminals C onto the trimmed wires, plug them into connector A maintaining color continuity and function with the original jumper harness, then plug this completed connection into the 2-position male connector from the jumper harness.
5. For 1969-72 applications that utilized a column mounted back up lamp switch, take the light green and pink back up lamp wires from step 2 above, crimp terminals C onto the trimmed wires, plug them into connector A in any order as indexing is not critical, then plug this completed connection onto the column mounted back up lamp switch.

For Console Shifted Automatic Transmission cars.

Courtesy lamp:

1. Plug the gray wire from the Automatic Transmission Console Shifter Light Harness into the open cavity on the Console Rear Courtesy Lamp Harness Extension. Snap the lamp socket terminals into the original location at the back end of your console, then install your bulb (**not included**).
2. Ground the ring terminals to the floor of the car in the stock location.
3. Plug the completed assembly into the mating connector at location 17 on page 3 on your dash harness (510107 for 1970-72 or 510160 for 1968-69) instructions.

NSS and back up lamp switch connections:

4. Select the "Automatic Transmission Console Neutral Safety Switch Extension" (as shown on page 1) and plug the 90 degree 2-position connector containing the purple wires onto the NSS connection on your shifter assembly.
5. Select the "Automatic Transmission Console Back Up Lamp Switch Extension" (as shown on page 1) and plug each of the two 90 degree single position connectors containing the pink and light green wires onto the back up connections on your shifter assembly.
6. Route the NSS and Back Up lamp wires found at locations 12 and 13 on page 3 of your dash harness (510107 for 1970-72 or 510160 for 1968-69) down to the NSS and back up lamp extension harnesses that you just installed onto the shifter, and trim them to length.
7. For the purple NSS wires, crimp terminals D onto the trimmed wires, plug them into connector B maintaining function with the dash harness (Solenoid vs. Neutral Safety), then plug this completed connection into the NSS extension from step 4.
8. For the light green and pink back up lamp wires, crimp terminals C onto the trimmed wires, plug them into connector A maintaining color continuity and function with the dash harness (back up vs. fused 12v ign), then plug this completed connection into the back up lamp extension from step 5.

For Column Shifted Automatic Transmission cars.

NSS and back up lamp switch connections:

1. Route the NSS and Back Up lamp wires found at locations 12 and 13 on page 3 of your dash harness (510107 for 1970-72 or 510160 for 1968-69) down to the base of the steering column near the firewall, and trim them to length.
2. Take the 2 purple NSS wires, crimp terminals D onto the trimmed wires, plug them into connector B in any order as indexing is not critical, then plug this completed connection onto the switch at the base of your steering column.
2. Take the light green and pink back up lamp wires, crimp terminals C onto the trimmed wires, plug them into connector A in any order as indexing is not critical, then plug this completed connection onto the switch at the base of your steering column.

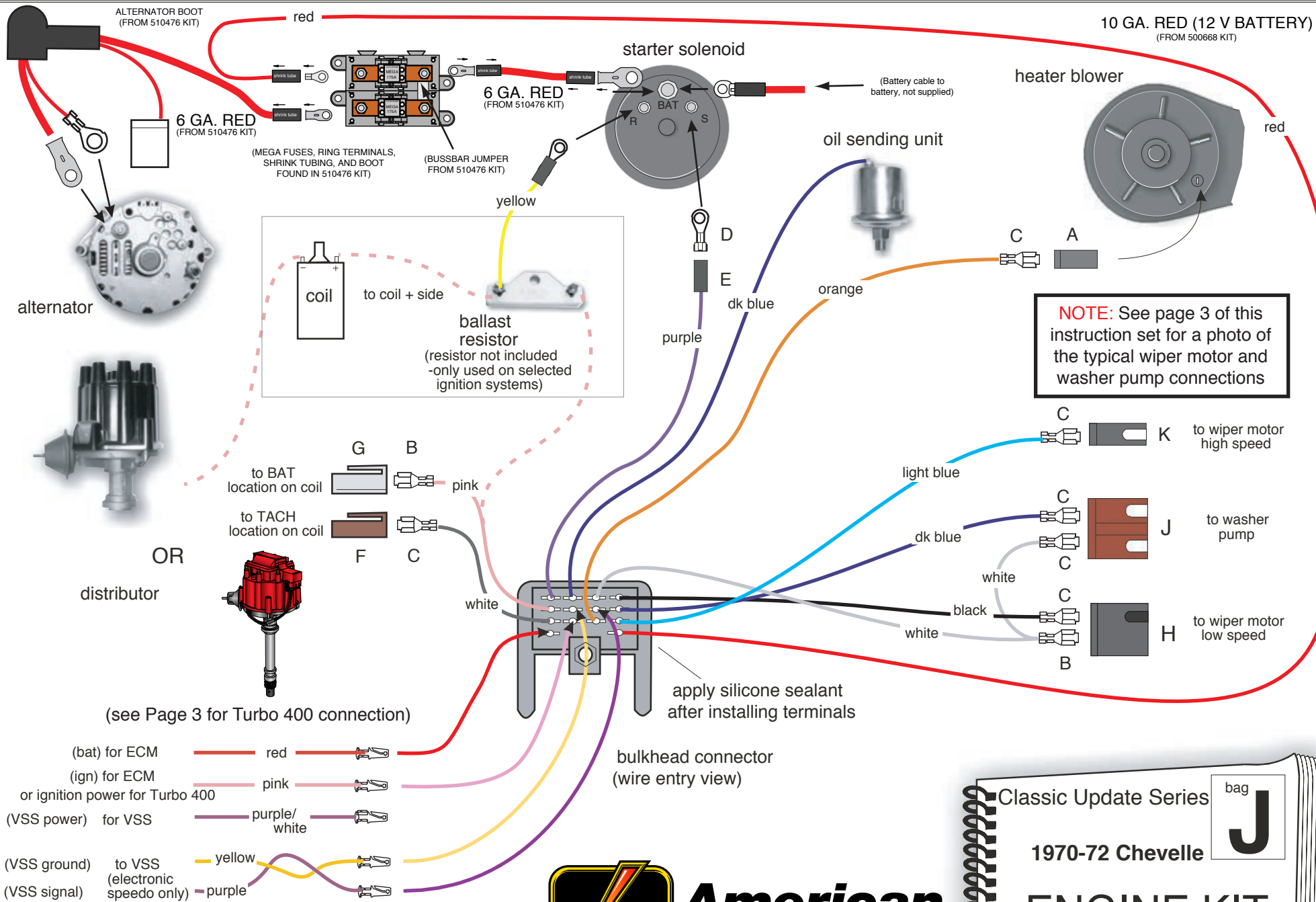

**American
Autowire**

www.americanautowire.com 856-933-0801

Classic Update Series bag
J

1970-72 Chevelle

ENGINE KIT

510108

92969169 instruction rev 3.0 1/11/2018

TEMPORARILY, PLUG THE MAIN BULKHEAD CONNECTOR FROM THIS KIT INTO THE MATING CONNECTOR ON THE DASH BULKHEAD CONNECTOR (LOCATED UNDER THE MASTER CYLINDER) Note: This will be unbolted to install the front light harness later.

BULKHEAD CONNECTOR WIRES

RED	(12 V BATTERY)	Route this wire to the Megafuse and cut to length. Use ring terminal, shrink tubing from 510476 kit. Connect as shown on page 1.
PURPLE	(STARTER SOLENOID)	Route to the starter solenoid and cut to length. Install rubber sleeve E and ring terminal D. Connect to the "S" terminal on the solenoid.
DARK BLUE	(OIL PRESSURE SENDER)	Connect this wire to the oil pressure sending unit. Using terminal P or terminal S together with connector R.
ORANGE	(HEAT / AIR)	If using after-market air conditioning, remove this wire. If using a stock heater only system, route this wire to the heater blower and cut to length. Install terminal C and connector A and plug into the blower unit.
PINK	(12 V IGNITION)	If using an HEI distributor or after-market ignition system which requires a 12 volt feed, route the PINK wire to the coil and trim to length. Install terminal C and connector G and plug into the distributor cap BAT location. If using a points type ignition system which requires reduced voltage, route the PINK wire to the ignition feed side of a ballast resistor (not included). Connect the loose piece YELLOW wire to the R terminal on the starter and connect the other end to the coil side of the ballast resistor. Connect a piece of left over PINK wire to the coil side of the ballast resistor and route to the distributor coil "+" side.
WHITE	(COIL-TACH)	Route this wire to the coil and trim to length. If using an HEI distributor, terminal B and connector F are included for connection. Plug into the "TACH" location of the negative side of the coil. If using a conventional point type distributor, install terminal "P" and connect to the negative side of the coil.

ALTERNATOR

HEAVY RED	(AMERICAN AUTOWIRE)	Use the 6ga red wire, boot and ring terminal from the 510476, route from alternator to the Megafuse and cut to length. Connect as shown on page 1.
SMALL RED		Send the ring terminal end of this wire through boot L(as shown on Page 1) and connect to the battery stud on the alternator. Do not plug the connector into the alternator yet. The exciter wire will be added when the front light wires are installed.

REMAINING LOOSE WIRES

RED	(12 V BATTERY)	These wires will be used only if you are using an ECM module mounted in the engine compartment, an electronic speedometer, or a Turbo 400 automatic transmission. (See page 3 for installation instructions). Used on ECM module which is mounted in the engine compartment. Plug this wire into the firewall bulkhead connector at the location shown on Page 1. Route the other end to the ECM harness "battery feed" wire.
PINK	(12 V IGNITION)	1. Used on ECM module which is mounted in the engine compartment. Plug this wire into the firewall bulkhead connector at the location shown on sheet 1. Route the other end to the ECM harness "ignition feed" wire. 2. Used for ignition power to a Turbo 400 transmission kickdown switch (see Page 4.)
PURPLE	(VSS SENDER)	Used on vehicles that have an electronic speedometer. Route this wire to the vehicle speed sensor and connect to the VSS signal lead wire.
YELLOW	(VSS GROUND)	Used on vehicles that have an electronic speedometer. Twist this wire with the PURPLE VSS SENDER wire to assure proper signal interference shielding. Route this wire to the vehicle speed sensor and connect to the VSS ground lead wire.

Once the main connector has had all of it's wires plugged in, the connector cavities should be sealed with Di-electric grease on the terminals. Also, to assure a moisture resistant seal, silicone can be applied to seal the outside of the connector.

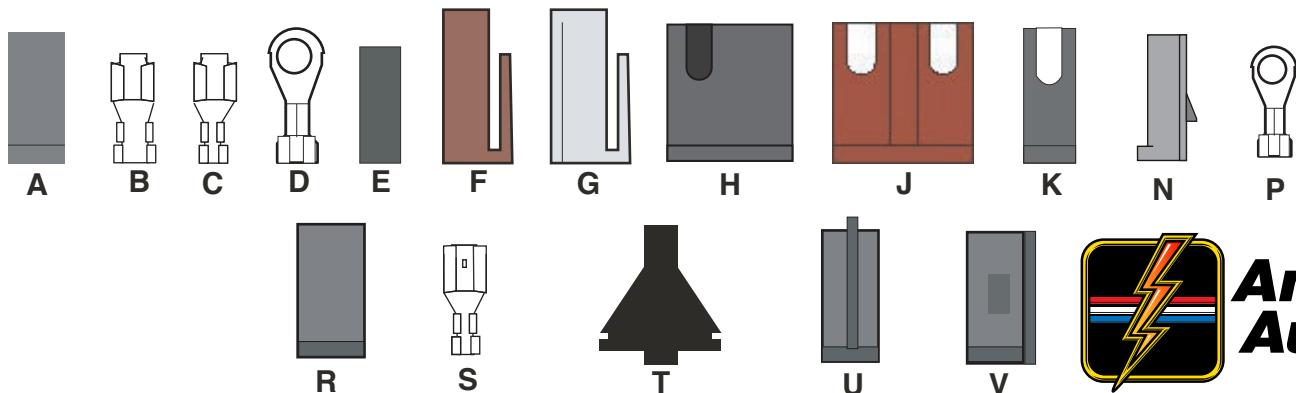

**American
Autowire**

www.americanautowire.com 856-933-0801

**ENGINE KIT
510108**

92969169 instruction rev 3.0 1/11/2018

WINDSHIELD WIPER WIRES

Terminal and connectors to make the proper connections on a stock wiper system are shown on page 1 of this instruction set. A photo of the completed connections installed onto a stock wiper and washer assembly are shown to the right. If using an after-market wiper system, follow the manufacturer's instructions.

BLACK	(WIPER LOW SPEED)	Route this wire to the wiper motor and trim to length. Install terminal C, and plug into connector H as shown on page 1 of this instruction set.
DARK BLUE	(WIPER WASHER)	Route this wire to the wiper motor and trim to length. Install terminal C, and plug into connector J as shown on page 1 of this instruction set.
LIGHT BLUE	(WIPER HIGH SPEED)	Route this wire to the wiper motor and trim to length. Install terminal C, and plug into connector K as shown on page 1 of this instruction set.
WHITE	(WIPER FEED)	Route this wire to the wiper motor and trim to length. Double this wire with the cut off portion, install terminal B, and plug into connector H as shown on page 1 of this instruction set. Route the loose end of the cut off portion to the washer pump and trim to length. Install terminal C, and plug into connector J as shown on page 1 of this instruction set.

with depressed park (hidden wipers)

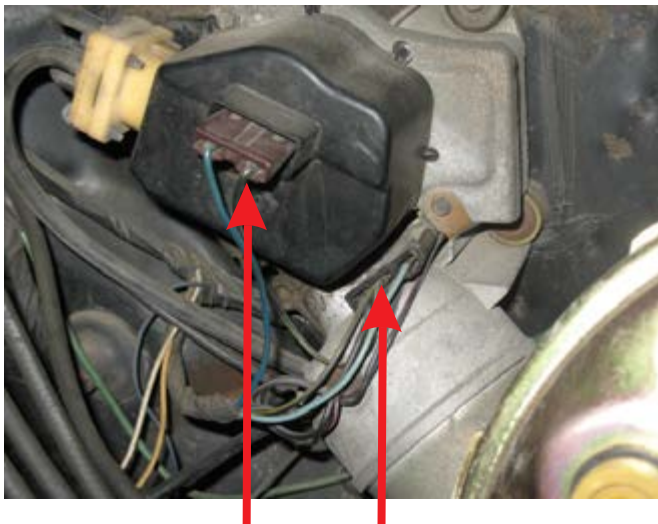

The photo above depicts the typical stock 1970-1972 Chevelle, El Camino, or Monte Carlo wiper motor and washer pump connections with a "depressed park" motor (hidden wipers). Where you see a black wire with a yellow stripe in the photo (red arrows), that would be equivalent to the AAW white "wiper feed" power wire.

w/o depressed park (non-hidden wipers)

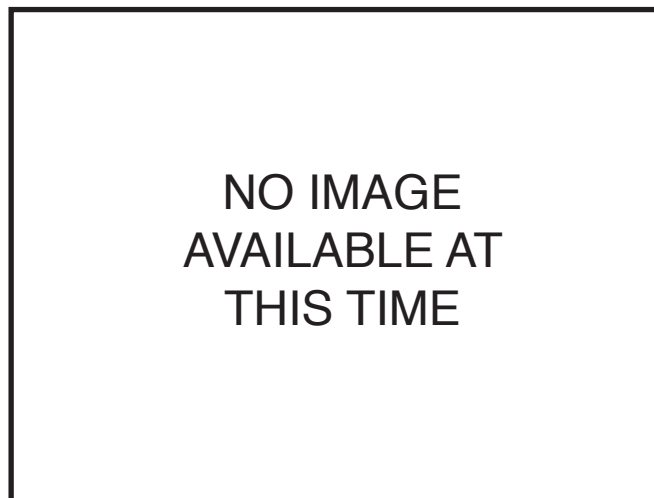

Sorry, but at this time, we do not have a photo of the "non-depressed park" wiper motor (non-hidden wipers).



www.americanautowire.com 856-933-0801

ENGINE KIT
510108

92969169 instruction rev 3.0 1/11/2018

The orange and pink wires that are shown below are for use with a stock, gas pedal mounted, 1970-1972 Turbo 400 automatic transmission kickdown switch.

Note: If your car was factory equipped with a Turbo 400 transmission, install grommet "T" into the existing factory hole in the firewall. If your car was not factory equipped with a Turbo 400 transmission and you are adding one to your build, and will be using a stock gas pedal mounted kickdown switch, you will need to drill a 3/4" hole in your firewall somewhere behind the left head of your engine. We have included plenty of wire, so the exact location of this new hole is not critical. Just be sure that you do not interfere with any other items in the engine compartment or under the dash.

PINK (12 V IGNITION)

Plug this loose piece (12 V IGNITION) wire into the bulkhead connector in the position shown below. Pass the other end through grommet "T" and back into the passenger compartment. Install terminal "C" and plug into connector "U". Plug connector "U" into the kickdown switch.

ORANGE (No Printing)

Use this loose piece wire and install the kickdown solenoid connector at the transmission. Pass the other end through grommet "T" and back into the passenger compartment. Install terminal "C" and plug into connector "V". Plug into the kickdown switch.

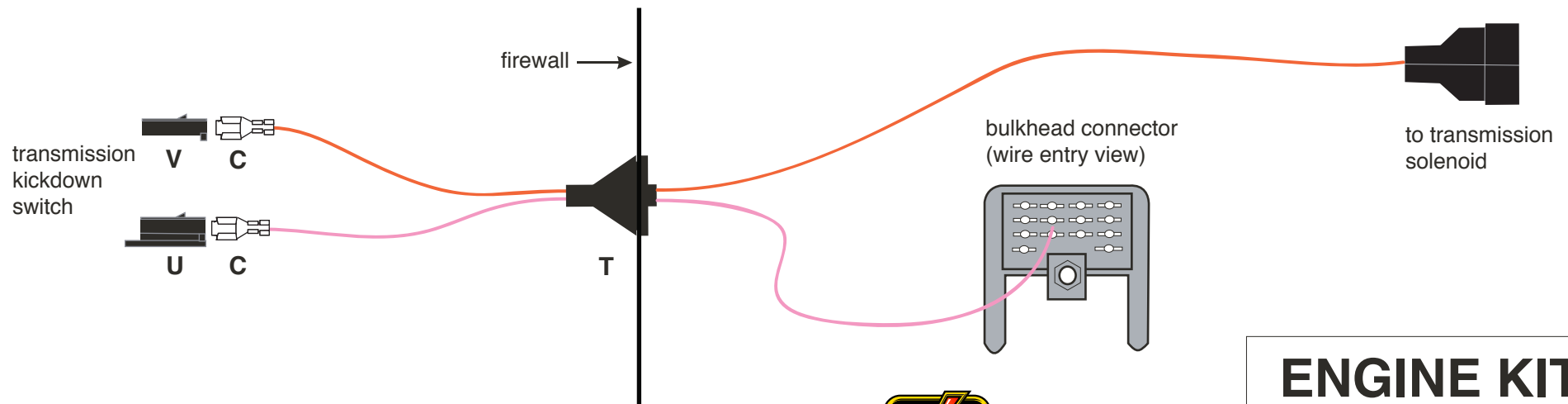

**American
Autowire**

www.americanautowire.com 856-933-0801

**ENGINE KIT
510108**

92969169 instruction rev 3.0 1/11/2018

Classic Update Series

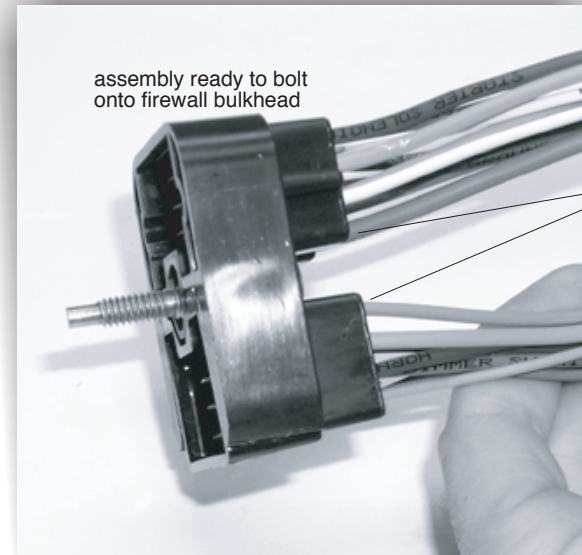
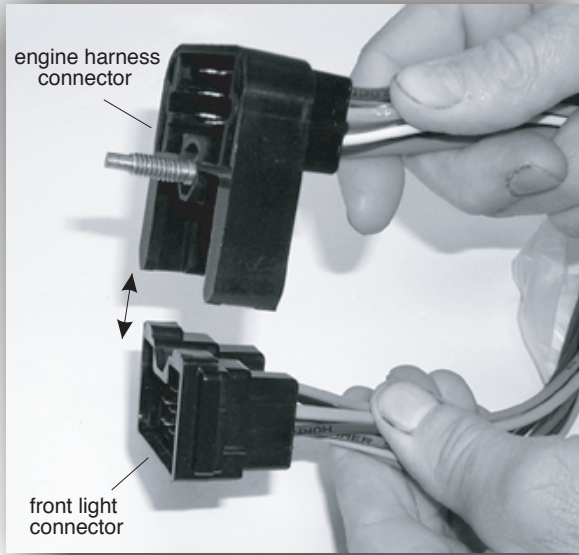

The bulkhead connector from this front light kit must snap into the mating engine connector (bag J), as shown. After snapping together, then bolt the assembly into the dash harness firewall connector using the attached bolt.

Look!



















**American
Autowire**

American Autowire
800-482-9473

American Autowire also sells factory OEM style harness wrap. this is the same stuff used on original Camaro harnesses! If you want that OEM look with your Classic Update wiring system, then give us a call and order p/n R0067108 !



1970 Chevelle Front Lighting

A		Connect the bulkhead connector from this kit onto the bulkhead connector from the engine kit (bag J), and bolt to the firewall bulkhead.		
B		LT BLUE	LH turn	Route this wire to the LH turn signal lamp and install terminal J and plug into connector H, as shown on sheet 1.
C		DK BLUE	RH turn	Route this wire to the RH turn signal lamp and install terminal J and plug into connector H, as shown on sheet 1.
D		BROWN BLACK	Parking Lamp Side Marker Grounds	Route the shorter of the 2 brown wires to LH parking lamp, cut to length, double this wire with the cut off portion, install terminal M and plug into connector H as shown on sheet 2. Route the other end through grommet Q down to the LH side marker lamp, cut to length, install terminal P, and plug into lamp socket N as shown on sheet 2. Install pre-terminated smaller gauge black wire with ring terminal through grommet Q, install terminal P, and plug into lamp socket N as shown on sheet 2. Ground the ring terminal to the radiator core support. Repeat this process using the longer of the 2 brown wires and going over to the RH parking and side marker lamps.
E				
F				
H		TAN (heavy gauge)	Lo Beam	Route this wire to the driver side outer headlight and trim to length. Double this wire with the cutoff portion, and install terminal B. Plug this terminal into connector A, in the location shown on sheet 2. Route the remaining portion of this TAN wire to the passenger side outer headlight and trim to length. Install terminal C and plug into connector A as shown on sheet 2.
J		LT GREEN	Hi Beam	Route this wire to the driver side outer headlight and trim to length. Double this wire with the cutoff portion, and install terminal B. Plug this terminal into connector A, make a short jumper over to the driver side inner headlight, cut to length, double it with the cutoff portion, install terminal B, and plug it into connector T in the location shown on sheet 2. Route the remaining portion of this LT GREEN wire to the passenger side inner headlight and trim to length. Double this wire with the cutoff portion, install terminal B and plug into connector T as shown. Make a short jumper over to the passenger side outer headlight, cut to length, double it with the cutoff portion, install terminal C, and plug it into connector A in the location shown on sheet 2.
L				
M				
N		BLACK	H/L Grounds	Route the pre-terminated heavier gauge black wire with ring terminal to the driver side outer headlight, trim to length, double this wire with the cutoff portion, install terminal B, and plug this terminal into connector A. Take the other end of the cutoff portion over to the driver side inner headlight, cut to length, install terminal C, and plug it into connector T in the location shown on sheet 2. Ground the ring terminal to the radiator core support. Repeat this process for the passenger side
P		DK GREEN	Horn	Route to horns and install terminals D & E, as shown on sheet 2, Plug into connectors L.
Q		ORANGE	Electric Fan	Route to the electric fan, and connect per manufacturer's instructions NOTE: We recommend that this wire be used as the trigger wire for the electric fan relay.
R		TAN	Brake Sender	Plug this wire into the stock brake sender switch.
S		DK GREEN	Water Temp	Connect this wire to the temperature sending unit using terminal R or terminal D and connector S (depending on your sending unit).
T		BROWN	Alternator Regulator	Route this wire to the alternator and cut to length. Install terminal D and plug into the regulator connector (previously installed from the engine kit 500668 bag J). NOTE: This wire is only used on an alternator with an internal regulator which uses an exciter wire. If you are using a true one wire alternator, then this BROWN wire can be removed and not used.

After all wires are installed from this kit, the main connector should have die-electric grease applied to the terminals. Also, to assure a moisture resistance seal, apply silicone sealant to the outside of the main connector around each wire.

1971-72 Chevelle Front Lighting



A

Connect the bulkhead connector from this kit onto the bulkhead connector from the engine kit (bag J), and bolt to the firewall bulkhead.



B

LT BLUE LH turn Route this wire to the LH turn signal lamp and install terminal J and plug into connector H, as shown on sheet 1.



C

DK BLUE RH turn Route this wire to the RH turn signal lamp and install terminal J and plug into connector H, as shown on sheet 1.



D

BROWN BLACK Parking Lamp Side Marker Grounds Route the shorter of the 2 brown wires to LH parking lamp, cut to length, double this wire with the cut off portion, install terminal M and plug into connector H as shown on sheet 4. Route the other end over to the LH side marker lamp, cut to length, install terminal P, and plug into lamp socket N as shown on sheet 4. Route the pre-terminated smaller gauge black wire with ring terminal over to the LH side marker lamp, cut to length, install terminal P, and plug into lamp socket N as shown on sheet 4. Ground the ring terminal to the radiator core support. Repeat this process using the longer of the 2 brown wires and going over to the RH parking and side marker lamps.



E



F

NOTE: You have been provided with LH and RH parking lamp extensions that must be terminated and plugged into connectors H as shown on sheet 4. Terminals D and connectors F have been provided for you to complete this installation. Please be certain to maintain color continuity between the lamp socket extensions and the front lamp harness.



H

TAN (heavy gauge) Lo Beam Route this wire to the driver side headlight, cut to length, double this wire with the cutoff portion, install terminal B, and plug into connector A in the location shown on sheet 4. Route the remaining portion of this TAN wire to the passenger side headlight, cut to length, install terminal C and plug into connector A in the location shown on sheet 4.

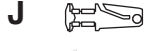

J

LT GREEN Hi Beam Route this wire to the driver side headlight, cut to length, double this wire with the cutoff portion, install terminal B and plug into connector A in the location shown on sheet 4. Route the remaining portion of this LT GREEN wire to the passenger side headlight, cut to length, install terminal C and plug into connector A in the location shown on sheet 4.



L



M

BLACK H/L Grounds Route the pre-terminated heavier gauge black wire with ring terminal to the driver side headlight, cut to length, install terminal B, and plug into connector A as shown on sheet 4. Ground the ring terminal to the radiator core support. Repeat this process for the passenger side.



N

DK GREEN Horn Route to horns and install terminals D & E, as shown on sheet 4, Plug into connectors L.



P

ORANGE Electric Fan Route to the electric fan, and connect per manufacturer's instructions
NOTE: We recommend that this wire be used as the trigger wire for the electric fan relay.

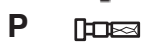

R

TAN Brake Sender Plug this wire into the stock brake sender switch.



S

DK GREEN Water Temp Connect this wire to the temperature sending unit using terminal R or terminal D and connector S (depending on your sending unit).



S

BROWN Alternator Regulator Route this wire to the alternator and cut to length. Install terminal D and plug into the regulator connector (previously installed from the engine kit 500668 bag J).

NOTE: This wire is only used on an alternator with an internal regulator which uses an exciter wire. If you are using a true one wire alternator, then this BROWN wire can be removed and not used.

After all wires are installed from this kit, the main connector should have die-electric grease applied to the terminals. Also, to assure a moisture resistance seal, apply silicone sealant to the outside of the main connector around each wire.

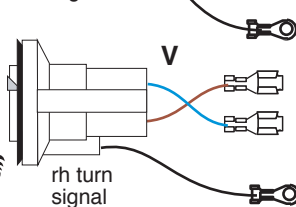
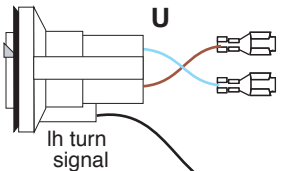

A  (1)
 (144.0" 6 Gauge charge wire)

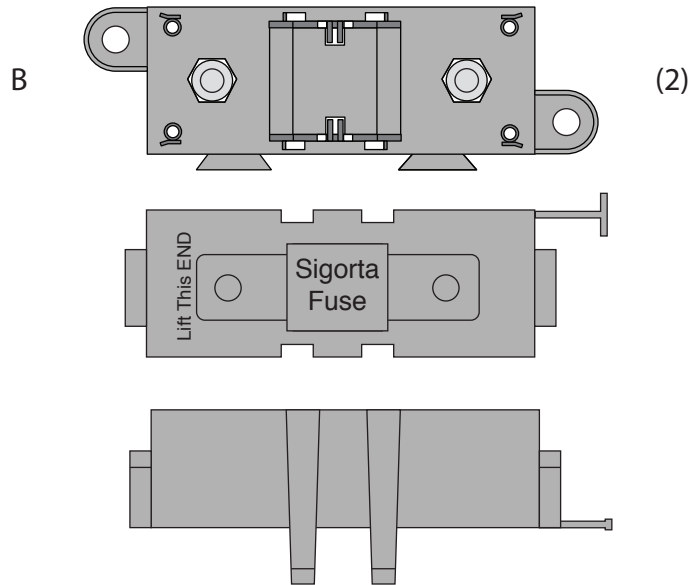

1. On this page, you will find the wire, fuse bodies, fuses, boot, ring terminals, and shrink tubing (items A through K) that are necessary to connect your alternator and main power feed for your new AAW wiring kit. Please be sure that all of the necessary components are present before starting this portion of your installation. If anything is missing, stop what you are doing and contact AAW at the number listed below right away.

2. On page 2, you will find directions for building the 2 Megafuse assemblies (items B,C and D) into one unit.

3. On page 3, you will find an overall concept of how to connect the Megafuse assemblies to your starter solenoid, alternator and main power feed of your new wiring system.

4. On page 4, you will find tips on building your charging circuit wires and assembling them and the main panel power feed wire to the Megafuse assemblies.

(Megafuse body, cover and two M8 x 1.25 nuts / lock washers)

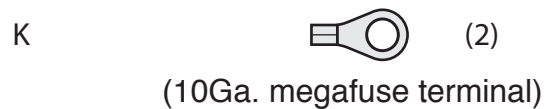
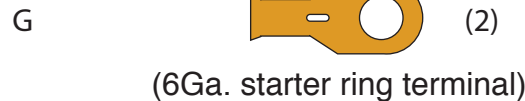
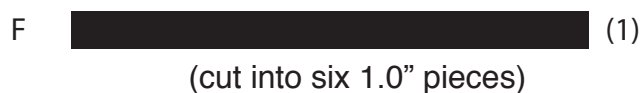
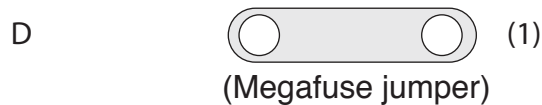
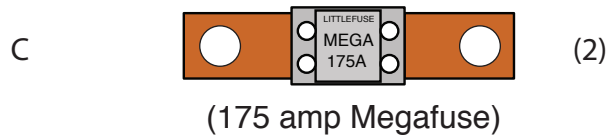

www.americanautowire.com 856-933-0801

PART #

510476

Z

DESCRIPTION:

Alternator and Main Power
 Connection Kit
 Various Applications

92972153 instruction sheet rev 0.1 6/24/2019

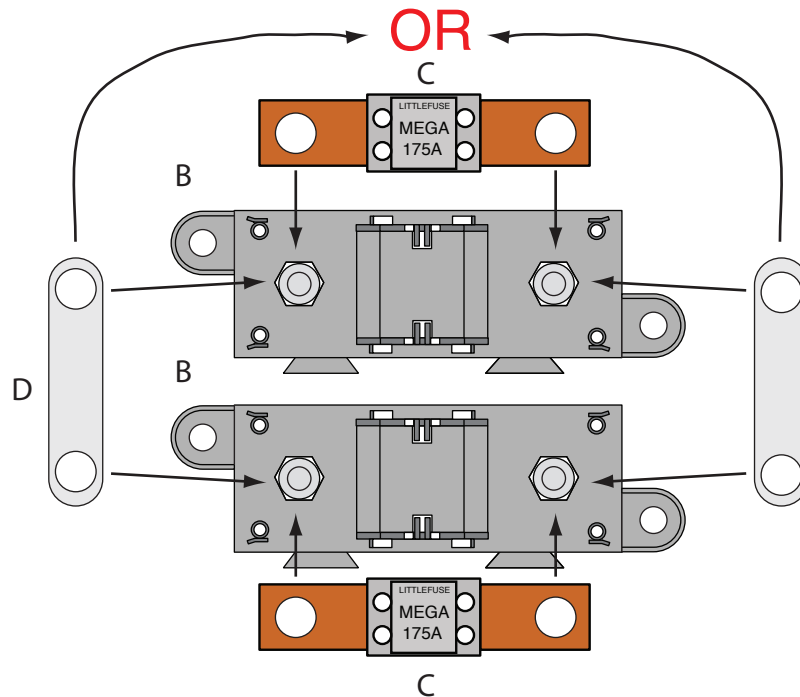

Assembling the (2) Megafuse assemblies

NOTE: Find a suitable place, as close to the battery power source as possible, under the hood of your vehicle to mount the completed Megafuse assemblies. Keep in mind that you have 12 feet of 6Ga. charging wire, and that the main power feed coming from your panel or bulkhead connection must also be able to reach the assembly.

1. Take the two Megafuse bodies and covers (items B) and snap them together. Remove the 4 nuts and lock washers from the studs on the fuse body assemblies.
2. Install the Megafuse jumper (item D above) over two of the studs on the Megafuse bodies. It is very important that the jumper **MUST BE** assembled on the side that is going to connect to your main power connection (starter solenoid or battery feed).
3. Notch top cover to clear jumper D as shown at right.
4. Snap one 175amp fuse (items C) onto the studs of each of the two Megafuse bodies (items B), over the jumper, then loosely re-attach the 4 nuts and lock washers back onto the assembled Megafuses. The fuse assemblies are ready to install into your vehicle.

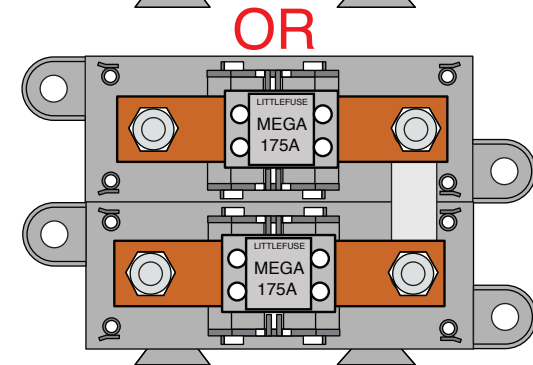
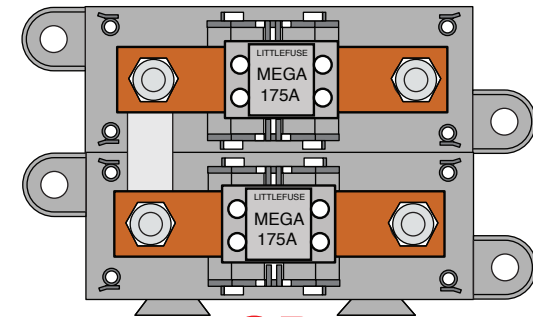

Assembled Megafuses

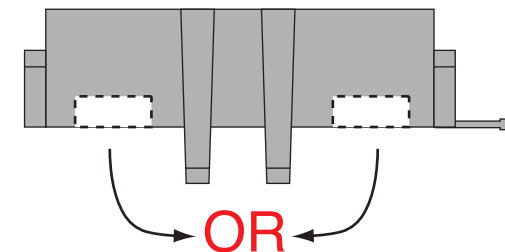

Notched Cover

PART #

510476

Z

DESCRIPTION:

Alternator and Main Power
Connection Kit
Various Applications

92972153 instruction sheet rev 0.1 6/24/2019

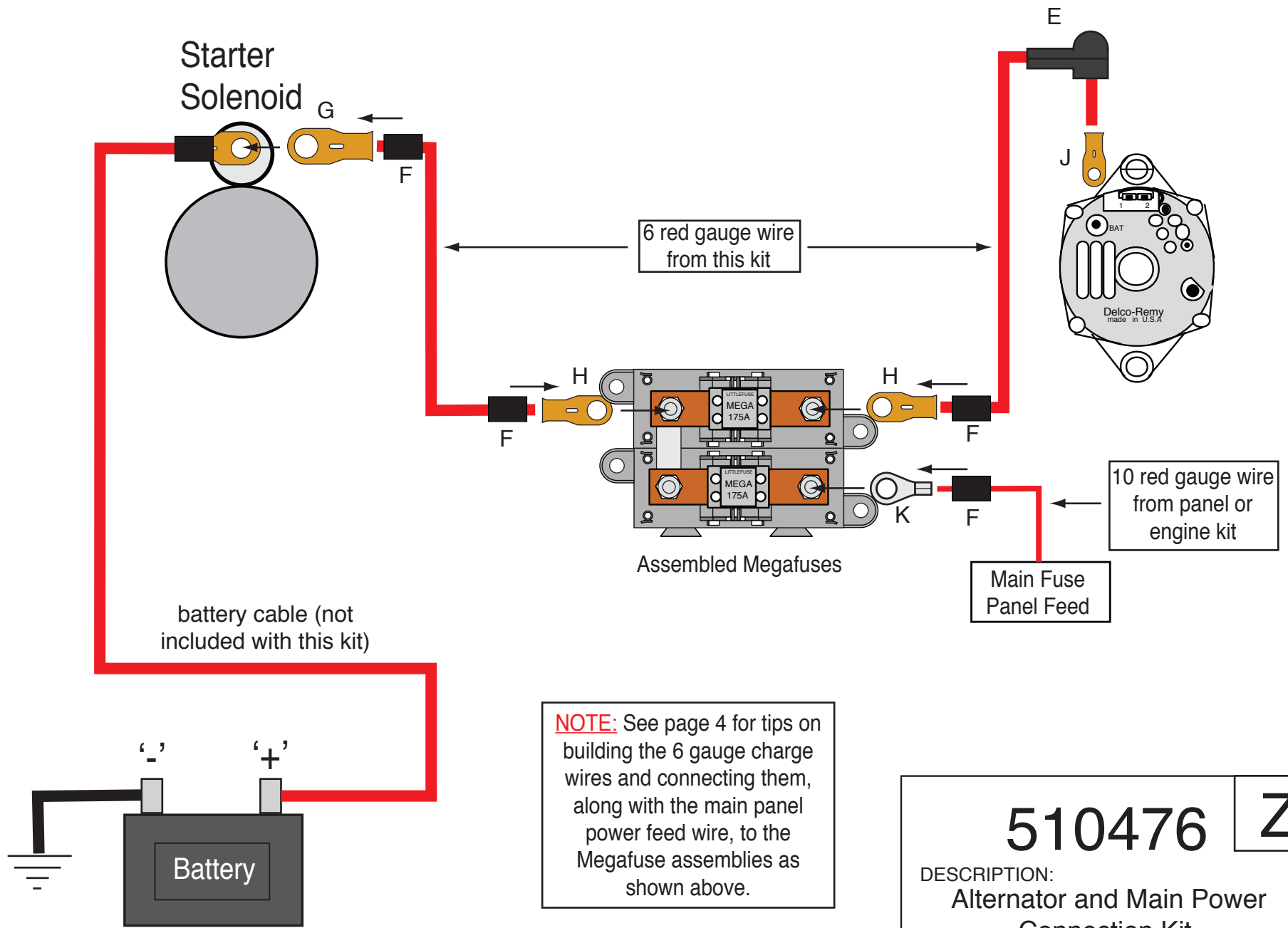

NOTE: See page 4 for tips on building the 6 gauge charge wires and connecting them, along with the main panel power feed wire, to the Megafuse assemblies as shown above.

<h1>510476</h1>	<h1>Z</h1>
<p>DESCRIPTION: Alternator and Main Power Connection Kit Various Applications</p>	
<p>92972153 instruction sheet rev 0.1 6/24/2019</p>	

Building the 6Ga. charge wires and connecting them and the main panel power feed wire to the Megafuse assemblies:

NOTE: Make sure that your battery is disconnected! You will need to install the preassembled Megafuses from page 2 in your vehicle to start this part of the installation.

1. Pre-cut item F shrink tubing into (6) 1.00" - 1.25" pieces.
2. Take the 12-foot piece of 6Ga. red wire from this kit and route it from your starter (or other battery feed) over to the area where you have mounted your Megafuse and cut it to length. Strip the insulation on each end back 1/2". Install 2 pieces of shrink tubing F onto the wire. At the starter end, crimp and solder (1) of terminal G onto the wire. At the Megafuse end, crimp and solder (1) of terminal H onto the wire. Slide the shrink tubing over the terminals and heat it up to shrink it down.
3. Take the remaining portion of the 12-foot piece of 6Ga. red wire from this kit and route it from your alternator over to the area where you have mounted your Megafuse and cut it to length. Strip the insulation on each end back 1/2". Install 1 piece of shrink tubing F onto the wire. At the alternator end, slip on boot E as shown on page 3, then crimp and solder (1) of terminal J onto the wire. At the Megafuse end, crimp and solder (1) of terminal H onto the wire. Slide the shrink tubing over terminal H and heat it up to shrink it down.
4. Take the 10Ga. red main power feed wire from your engine or panel sub-kit and route it over to the area where you have mounted your Megafuse and cut it to length. Strip the insulation back 3/8". Install 1 piece of shrink tubing F onto the wire, then crimp and solder (1) of terminal K onto the wire.
5. Remove the 4 loosely tightened nuts and lock washers from the assembled Megafuses, then using the drawing on page 3 as a guide, install your pre-assembled wires from steps 2-4 above. Re-install the 4 nuts and lock washers onto the assembled Megafuses and tighten them down. This part of your installation is now complete.

510476

Z

DESCRIPTION:

**Alternator and Main Power
Connection Kit
Various Applications**

92972153 instruction sheet rev 0.1 6/24/2019

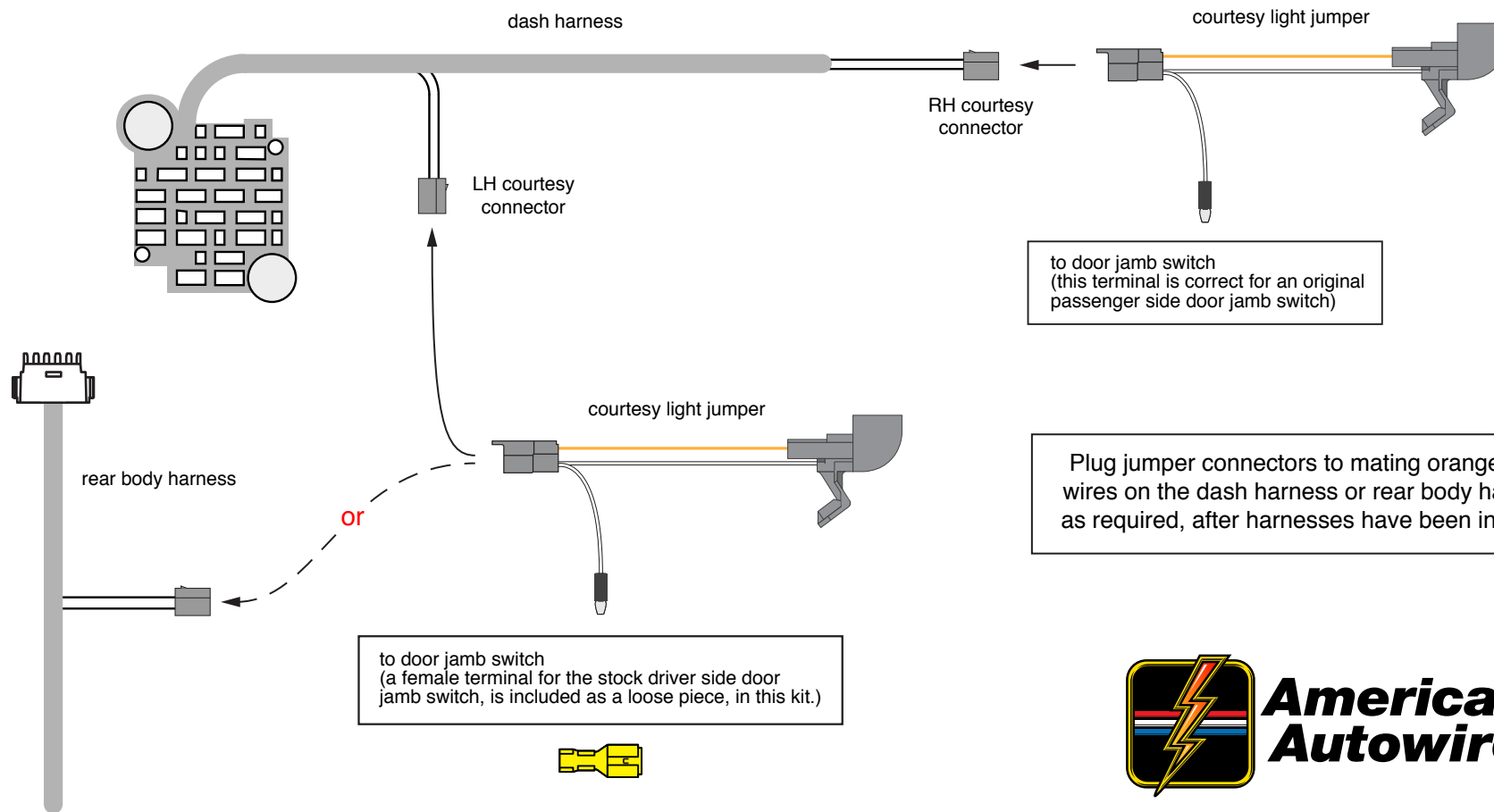

Plug jumper connectors to mating orange/white wires on the dash harness or rear body harness, as required, after harnesses have been installed.



**American
Autowire**

www.americanautowire.com 856-933-0801

NOTE: Your new underdash courtesy light kit uses # 631 bulbs (not included with this kit). They may be purchased at any auto parts store.

PART #

500708

N

DESCRIPTION:

Courtesy Light Kit

92966085

Rev 1.1

6/27/2016

Classic Update Series

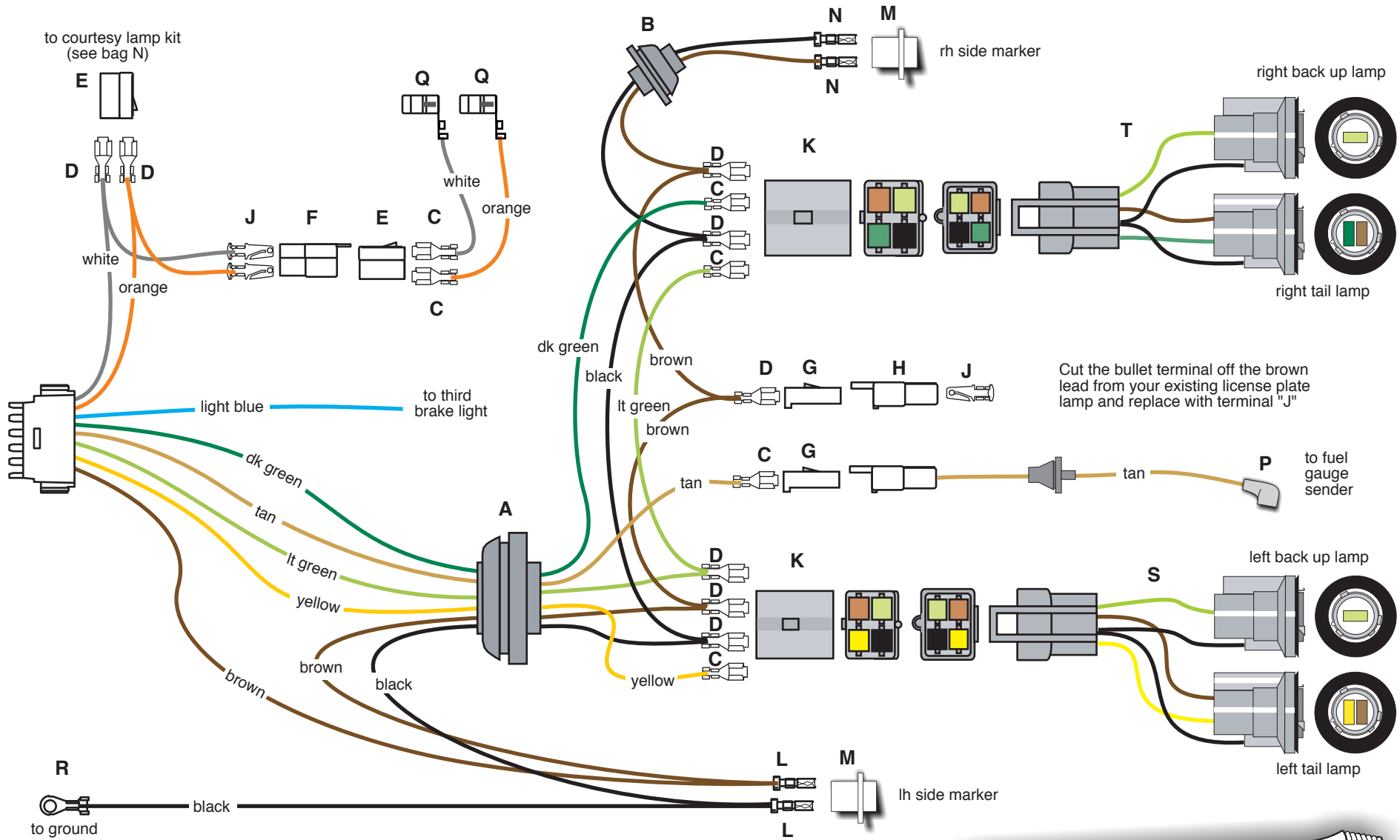

**American
Autowire**

American Autowire
800-482-9473

Classic Update Series
1970-72 Chevelle

bag
M

REAR BODY KIT

510111

92969181 instruction rev 1.0 4/10/2013

USE THIS SHEET FOR ALL 1970-72 CHEVELLES

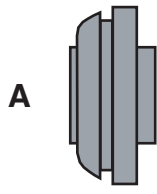

A

Connect the main connector to the mating connector on the dash harness 510107 (Bag G). Route this harness along the door sill threshold cavity to the rear of the car.

NOTE: Before starting, install grommets A (larger) and B (smaller) into the rear quarter panels in the same direction as shown on sheet 1. You have been provided with 2 tail lamp pigtails "S" (LH with yellow wire), and "T" (RH with dk. green wire). These will plug into the RB connection as shown on sheet 1.

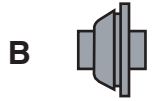

B

LIGHT BLUE THIRD BRAKE LIGHT Connect to the third brake lamp, if equipped.



C

TAN GAS GAUGE Route this wire through grommet A to the fuel tank area, cut to length, install terminal C and plug into connector G as shown on Page 1.



D

TAN Fuel tank lead (with rubber end) Plug the rubber end of this wire R onto the sending unit on fuel tank. Route the wire to the stock feed thru hole in trunk floor, pull the assembly up through the floor, and plug into connector G as shown on Page 1.



E



F

BROWN PARKING LAMPS Route this wire to the left side marker lamp and trim to length. Double this wire with the cut off portion, install terminal L, and plug into lamp socket M. Route the loose end through grommet A to the LH tail lamp connection and trim to length. Double this wire with the cut off portion, install terminal D, and plug into connector K in the exact location as shown on Sheet 1. Route the loose end to the tag lamp, and trim to length. Double this wire with the cut off portion, install terminal D, and plug into connector G as shown on Sheet 1.



G



H

NOTE: Your existing license plate lamp wire will plug into connector G as shown on sheet 1 (terminal J and connector H have been provided for you to make this connection). Route the loose end to the RH tail lamp connection and trim to length. Double this wire with the cut off portion, install terminal D, and plug into connector K in the exact location as shown on Sheet 1. Route the loose end through grommet B to the RH side marker, trim to length, install terminal N and plug into lamp socket M as shown on sheet 1.



J

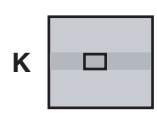

K



L

BLACK GROUND

Attach ring terminal on wire R to a good chassis ground, route the loose end to the left side marker lamp and trim to length. Double this wire with the cut off portion, install terminal L, and plug into lamp socket M. Route the loose end through grommet A to the LH tail lamp connection and trim to length. Double this wire with the cut off portion, install terminal D, and plug into connector K in the exact location as shown on Sheet 1. Route the loose end to the RH tail lamp connection and trim to length. Double this wire with the cut off portion, install terminal D, and plug into connector K in the exact location as shown on Sheet 1. Route the loose end through grommet B to the RH side marker, trim to length, install terminal N and plug into lamp socket M as shown on sheet 1.



M



N



P

YELLOW LH STOP / TAIL

Route this wire through grommet A to the LH tail lamp, cut to length, install terminal C, and plug this wire into connector K in the exact location as shown on Sheet 1.



Q



R

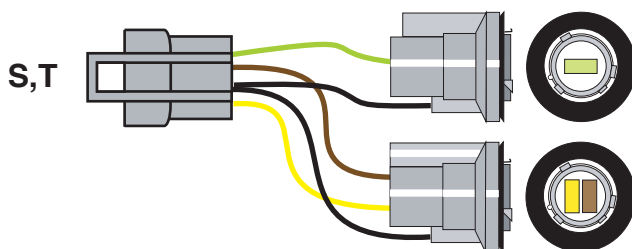

Classic Update Series

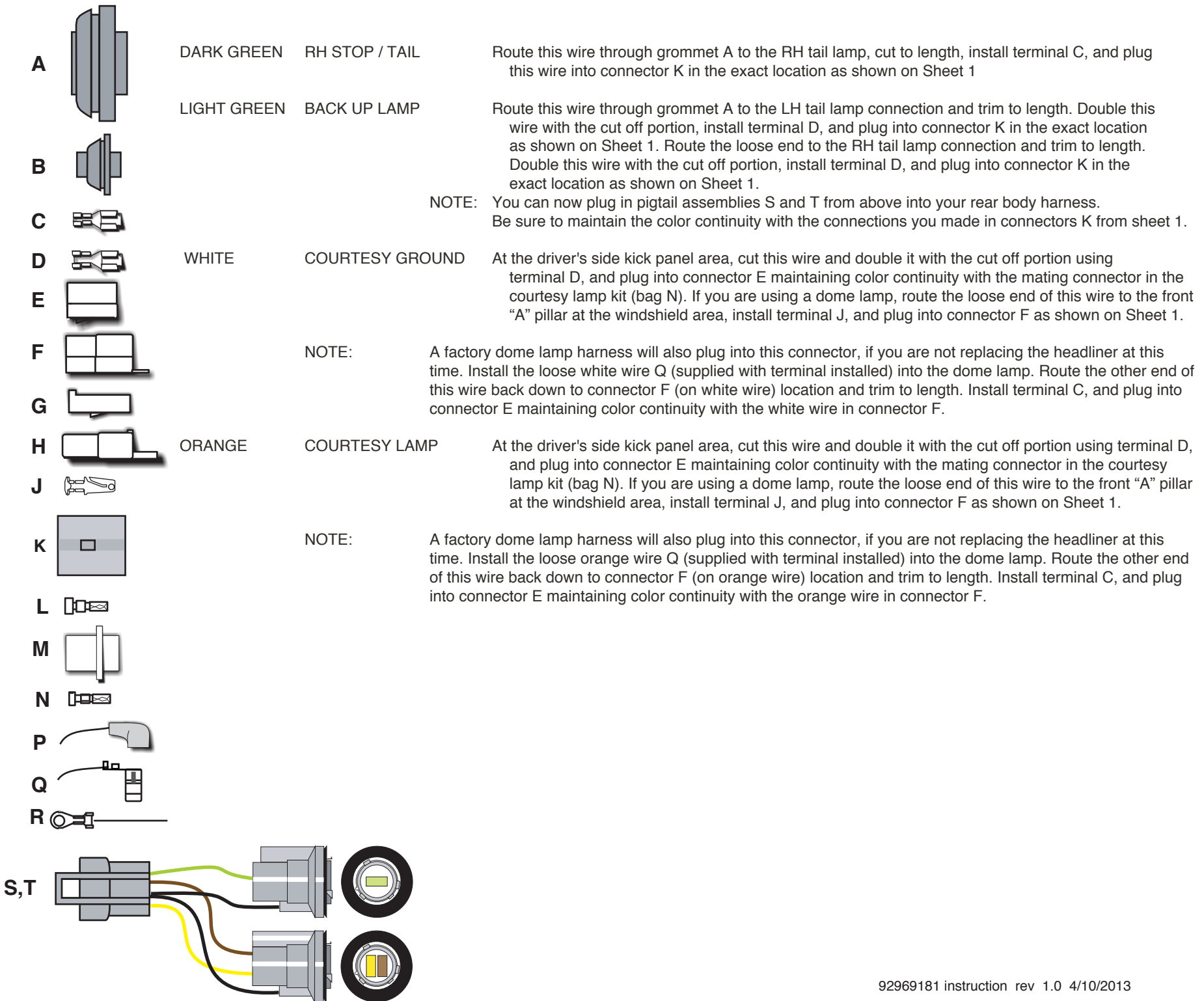

Most switches supplied with Classic Update and Universal Kits ship with the shaft pre-installed. In many instances, the switch can be installed without removing the shaft, but in some cases the switch shaft may need to be trimmed to fit your specific dash. In this situation, reference Trim to Fit instructions on the back of this page for details.

To install your new headlight switch:

1. Install the switch from behind the dash, and align the switch body with the mounting hole. The switch body has an alignment tab that must line up with the notch in the dashboard mounting hole.

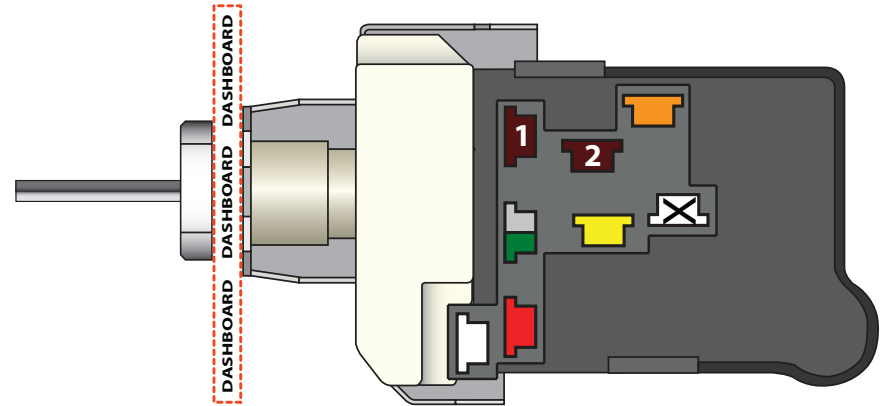
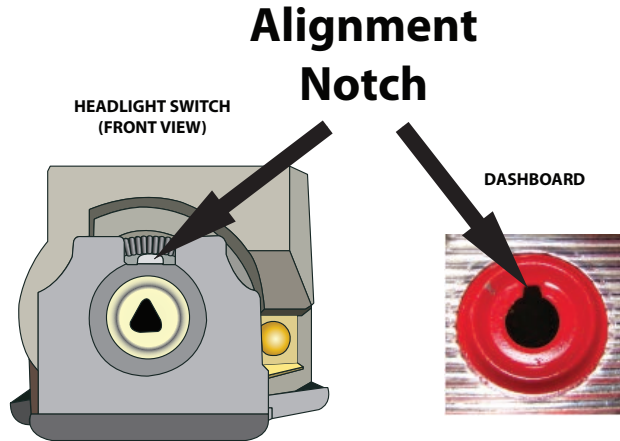

1	Parking Lights - Stay on with headlights
2	Tail Lights - On in the park and headlight positions
	Fused Battery Feed - For park, tail and dash lamps
	Headlight Feed - Power to the headlight dimmer switch
	12V Battery Feed - Unfused power to the switch for headlights
	Courtesy Ground - Ground feed to the dome and courtesy lights
	Part-time Parking Lights - Turns off when the headlights are on (Not supported by all kits)
	Dash Lights - Output to the dash light fuse or lights

2. Install the switch mounting nut and tighten.
3. Gently press shaft into switch until it stops, then press firmly until it "clicks." Pull shaft back out to confirm it is seated correctly. The shaft should be locked into place inside switch.
4. If the shaft does not lock, reinsert applying moderate pressure and slowly move shaft side to side for lock to engage. Make sure switch body is still supported to prevent flexing. Press shaft firmly until it clicks into place.
5. Ensure the shaft is fully seated and in the off position.



www.americanautowire.com 856-933-0801

PART # **500332**
 DESCRIPTION:
Headlight Switch

92964649 Rev 3.0 1/10/2020

To Trim Shaft to Fit or Remove Shaft:

The headlight shaft knob should extend from the face of the mounting nut, and must allow enough clearance for the switch to turn off. If the shaft is longer than necessary for your specific dash it can be trimmed to fit. Always trim the knob end of the shaft only and follow the guidelines below for best results.

1. With the headlight switch installed, loosen the set screw and remove the knob. Make sure the switch is in the "off" position by pushing the shaft toward the back of the switch.

Switch in OFF position
(shaft pushed all the way in)

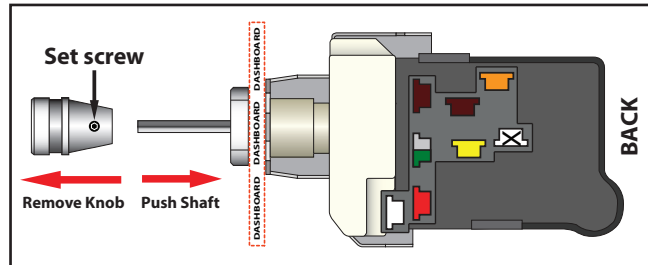

2. Set knob alongside shaft and mark the desired location for cutting on the shaft.

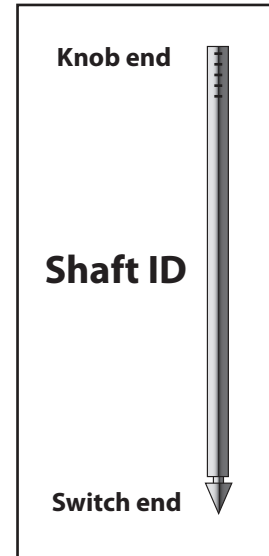
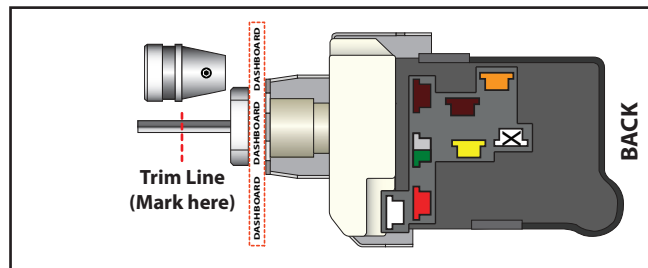

3. Remove the shaft and trim at mark. The shaft can be released from the switch by pulling it outward (toward the rear of the vehicle). Once fully in the "On" position, press and hold the release button on the base of the switch body. Once button is pressed, continue to pull the shaft outward. New switches may be tight, and it might be necessary to move the shaft side to side slightly while pulling to release.

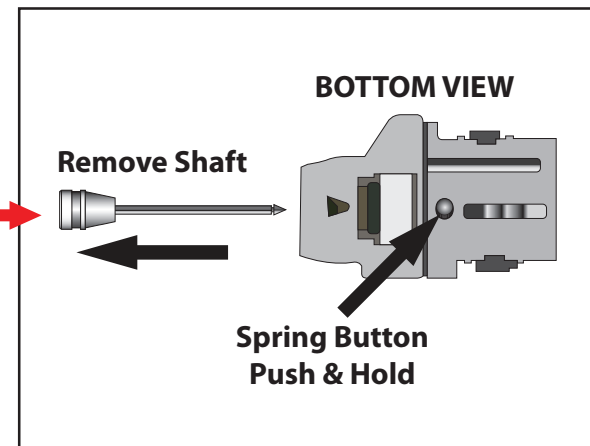
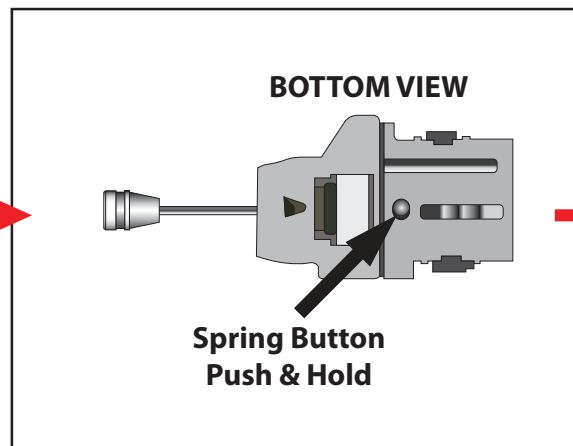
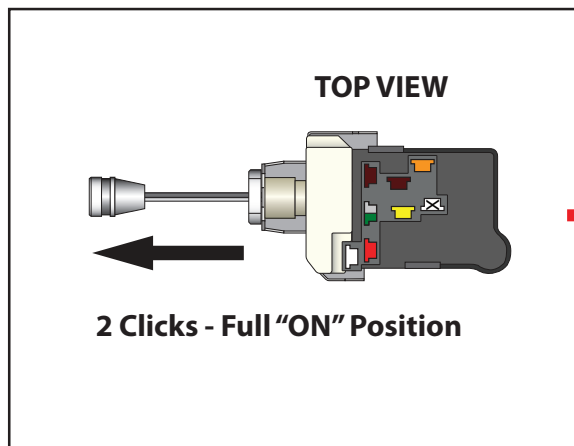

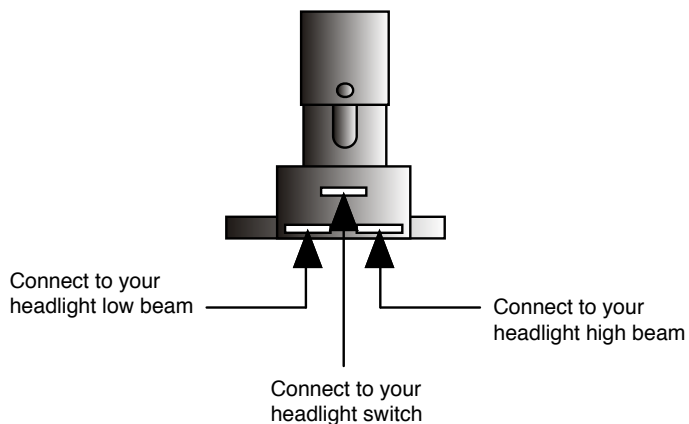

Connect the Dimmer Switch wires as shown above.

1. The top center terminal of the Dimmer Switch is connected to the Headlight switch.
2. The terminal on the right side is connected to your headlight high beam terminal.
3. The terminal on the left side is connected to your headlight low beam terminal.



www.americanautowire.com 856-933-0801

PART #

500042

DESCRIPTION:

DIMMER SWITCH

92964573 Rev 3.1 12/5/2014

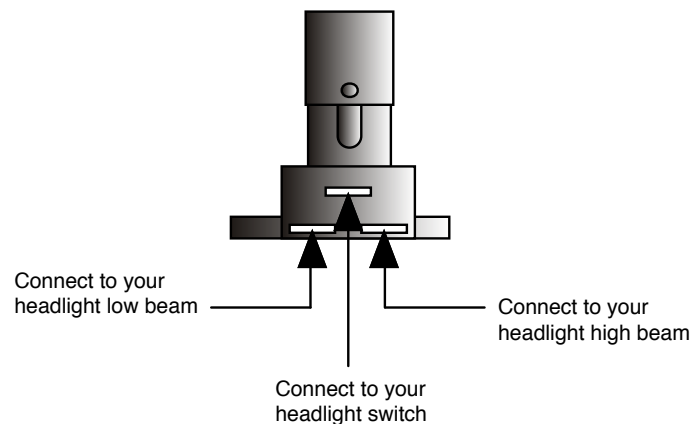

Connect the Dimmer Switch wires as shown above.

1. The top center terminal of the Dimmer Switch is connected to the Headlight switch.
2. The terminal on the right side is connected to your headlight high beam terminal.
3. The terminal on the left side is connected to your headlight low beam terminal.



www.americanautowire.com 856-933-0801

PART #

500042

DESCRIPTION:

DIMMER SWITCH

92964573 Rev 3.1 12/5/2014