

Fuse Box

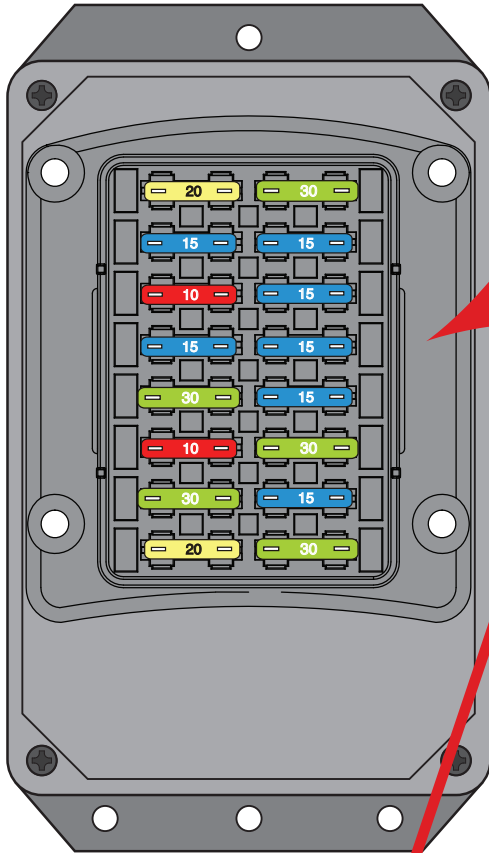

Fuse Box Lid

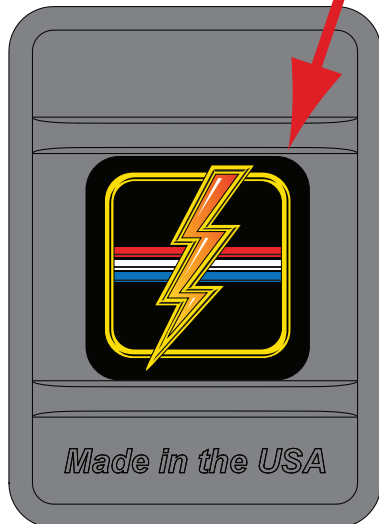

**NOTE:**

If your fuse box and fuse box lid look like this, these **ARE** the correct instructions for your application. If the word "BUSSMANN" appears on your fuse box or fuse box lid, you have an earlier version of this kit and these **ARE NOT** the correct instructions.

**KIT BOX CONTENTS:**

<u>Number</u>	<u>Description</u>
510476	Alternator & Main Power Connection Kit
510889	Main Dash Harness Kit w/ AAW Fuse Panel
510263	Rear Body Wiring Kit
510306	Headlight Bucket Wiring Kit
510307	Instrument Cluster Wiring Kit
510730	Vehicle Speed Sensor, VSS, Lead Wires
510905	Front Light Wiring Kit
510906	Engine Wiring Kit
500042	Floor Dimmer Switch
510145	Fuse, Relay & Flasher Kit
510264	Headlight Switch
510309	Ignition Switch
510312	Grommet & Parts Kit
500919	Practice Terminal Kit
92973564	Kit Instruction Sheets
92973603	Warning Page



**American  
Autowire**

www.americanautowire.com 856-933-0801

Classic Update Kit  
1953-56 Ford Truck  
**510303**

92973794 Rev. 0.0 03/22/2024



**WARNING: This harness is intended to be used in a modified vehicle. Please read this sheet thoroughly and be sure that you understand everything explained on it prior to opening any of the enclosed packages, or before attempting to install any of the components. Once this kit has been opened or a component installed, the kit is not returnable.**

1. This kit should typically be used in a **MODIFIED** application only. It **WILL NOT** support a stock 1953-55 six volt system with a generator. You **MUST** use a voltage reducer if you do choose to utilize your stock 1953-55 six volt dash gauges with this wiring system.
2. This kit only supports the use of a higher current self-exciting 1 wire, or other style internally regulated alternator. An adapter may be necessary for certain applications. The use of a stock, low amperage alternator is seriously discouraged as they cannot handle the higher current requirements of updated ignition systems, electric fans, aftermarket A/C systems, stereo systems, air ride suspensions, and other power hungry accessories and will ultimately create performance issues with the system.
3. This kit **WILL NOT** support the use of a factory ammeter. All AAW kits are engineered to supply the optimum charge to the battery. To achieve this performance, we route our 6ga. charge wire directly from the alternator output terminal to the starter solenoid. Due to the path of the charge being altered from the stock configuration, the gauge can no longer see a charge vs. a discharge, so it will not work properly. When ammeters were originally used, most generator or alternator current outputs were rated at maximum of about 25-60 amps. Modified cars being built today typically utilize a 100 amp or higher output alternator. With these higher current units, ammeters, generally speaking, become a safety hazard. Ammeters are usually wired in parallel to the charging circuit, are typically unfused, and can short very easily causing a fire. A voltmeter is recommended as an alternative.
4. This kit **IS NOT** set up with a resistance wire or a ballast resistor for a standard, points type ignition system. It is wired with a full 12 volt primary ignition feed that is hot in both the start and run positions. It will support HEI, MSD, other electronic ignition systems, as well as computerized Fuel Injection systems. If you wish to run a points type system, there are illustrations on the engine connection pages to do so. Extra parts that are not included in this kit will be required to complete that operation.
5. If you are using this new AAW kit in a 1953-55 Ford Truck that originally had a 6 volt system, you will find that the threads on your original headlight switch nut are too small in diameter to work with the new AAW 510264 switch included in this kit. You will need to purchase a new 1956 12 volt style replacement nut which is larger in diameter and will fit this new AAW switch and still allow for the use of your stock dash bezel. These are readily available from your favorite truck parts supplier.



**510303**



## 510303 - Classic Update Series Kit 1953-56 Ford Truck

This kit contains the following components:

<u>Bag</u>	<u>Part Number</u>	<u>Description</u>	<u>Quantity</u>
	500042	Floor Dimmer Switch	1
	500919	Practice Terminal Crimping Set	1
	510145	Fuse, Relay, and Flasher Kit	1
M	510263	Rear Body Wiring Kit	1
	510264	Headlight Switch	1
G	510889	Dash and Main Harness Kit	1
N	510306	Headlight Bucket Kit	1
H	510307	Dash Cluster Kit	1
J	510905	Front Light Kit	1
K	510906	Engine Kit	1
	510309	Ignition Switch	1
	510312	Grommet, Clamp, and Parts Kit	1
V	510730	VSS Connection Kit	1
Z	510476	Alternator and Main Power Connection kit	1
	92973564	Instruction Sheet for 510303, 53-56 truck kit	1
	92973603	Warning Sheet	1

Validate the kit contents with this component list. If there are any discrepancies with incorrect or missing parts, stop your installation and notify the supplier you purchased the kit from before proceeding



**American  
Autowire**

www.americanautowire.com 856-933-0801

# 510303

92973603 instruction sheet Rev 0.0 6/4/2021

# Classic Update Series

1953 - 1956 Ford Truck

## START HERE !

PLEASE READ THIS BEFORE STARTING INSTALLATION !

This wiring kit is designed for ease of installation. Please read the guidelines below, BEFORE STARTING your installation to guarantee a successful job. Use an appropriate crimping tool which folds the wings of the open barrel terminals down into the wire as shown below. ALL TERMINALS THAT YOU INSTALL SHOULD BE PROPERLY SOLDERED. Our factory crimped terminations are installed by GM approved five ton presses, and soldering these terminations is not necessary. AAW offers a great terminal crimping video entitled "Proper Crimping Video". It can be viewed by visiting YouTube. Type the following address into your web browser to go directly to the video: [www.youtube.com/watch?v=8u\\_EkMsiomy](http://www.youtube.com/watch?v=8u_EkMsiomy).



**AS THIS HARNESS IS DESIGNED FOR USE IN A MODIFIED TRUCK REQUIRING A HIGHER RATE OF CHARGE, IT DOES NOT SUPPORT THE USE OF A STOCK (ORIGINAL) ALTERNATOR OR GENERATOR. IT IS DESIGNED FOR USE WITH AN INTERNALLY REGULATED GM "SI" STYLE OR SINGLE WIRE STYLE ALTERNATOR. ADAPTERS (WHICH ARE NOT INCLUDED WITH THIS KIT) THAT ARE AVAILABLE FROM SEVERAL SOURCES WILL BE NECESSARY TO USE ANY ALTERNATOR OTHER THAN A 1 WIRE UNIT.**

#### STEP 1: DISCONNECT YOUR BATTERY:

Disconnect the battery before installing the wiring kit to prevent any accidental shorting caused by loose bare wire ends.

#### STEP 2: START INSTALLING KIT:

This kit is broken down into individual steps that are identified by a letter printed on the instruction sheets visible through each bag. These letters are the order of operation for installing your kit. Start with bag letter G, then M, etc. The order of installation is shown below. Use this main instruction sheet, 92969976, to complete the installation process.

G - 510889 Dash Harness Kit  
H - 510307 Gauge Cluster Kit  
J - 510905 Front Light Kit  
K - 510906 Engine Kit  
M - 510263 Rear Body Kit  
N - 510306 Headlight Bucket Kit  
V - 510730 Headlight Bucket Kit  
Z - 510476 Alternator and Main Connection Kit

#### STEP 3: RECONNECT YOUR BATTERY:

When you have completed the installation and are ready to reconnect the battery, make sure that the following electrical system grounds are in place:

- A. Battery is grounded to the ENGINE BLOCK.
- B. Battery is grounded to the frame.
- C. Engine block is grounded to the frame.
- D. Body is grounded to the frame.

#### STEP 4: CHECK ALL ELECTRICAL FUNCTIONS:

Any non-functioning items should be checked for proper installation. Any problems with your wiring and electrical circuit functions should be addressed to American Autowire Systems, Inc. as soon as possible to avoid any warranty problems.

If you have any questions concerning this or any of our products, please feel free to call us at 1-856-933-0801.

AMERICAN AUTOWIRE MAKES IT EASY !!

We carry many accessories for your 1953-1956 Ford truck

p/n 510585

OEM small terminal crimping tool (18-14 gauge)



p/n 510586

OEM large terminal crimping tool (12-8 gauge)

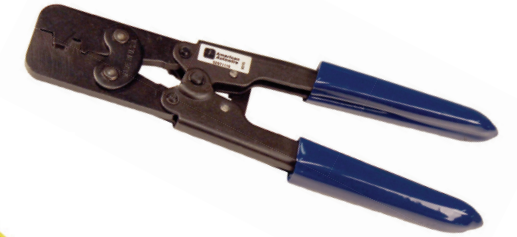

p/n 500918

Ford Duraspark Ignition Harness



p/n 500802

Ford Gen III Alternator Adapter

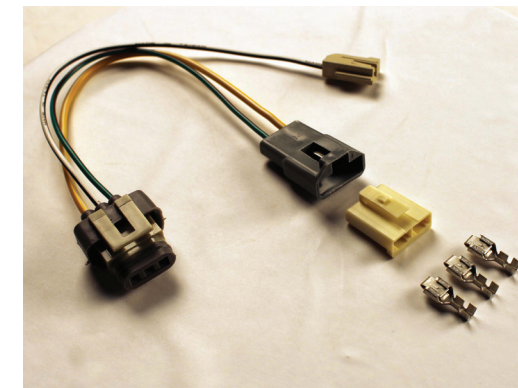

p/n R0067108

OEM style non-stick harness tape



[www.americanautowire.com](http://www.americanautowire.com) 856-933-0801

# 1953-56 Ford Truck

## Classic Update Series

### 510303

© COPYRIGHT 2004 American Autowire / Factory-Fit

Used with express permission of  
American Autowire / Factory-Fit

92973564 Rev 0.0 2/1/2022

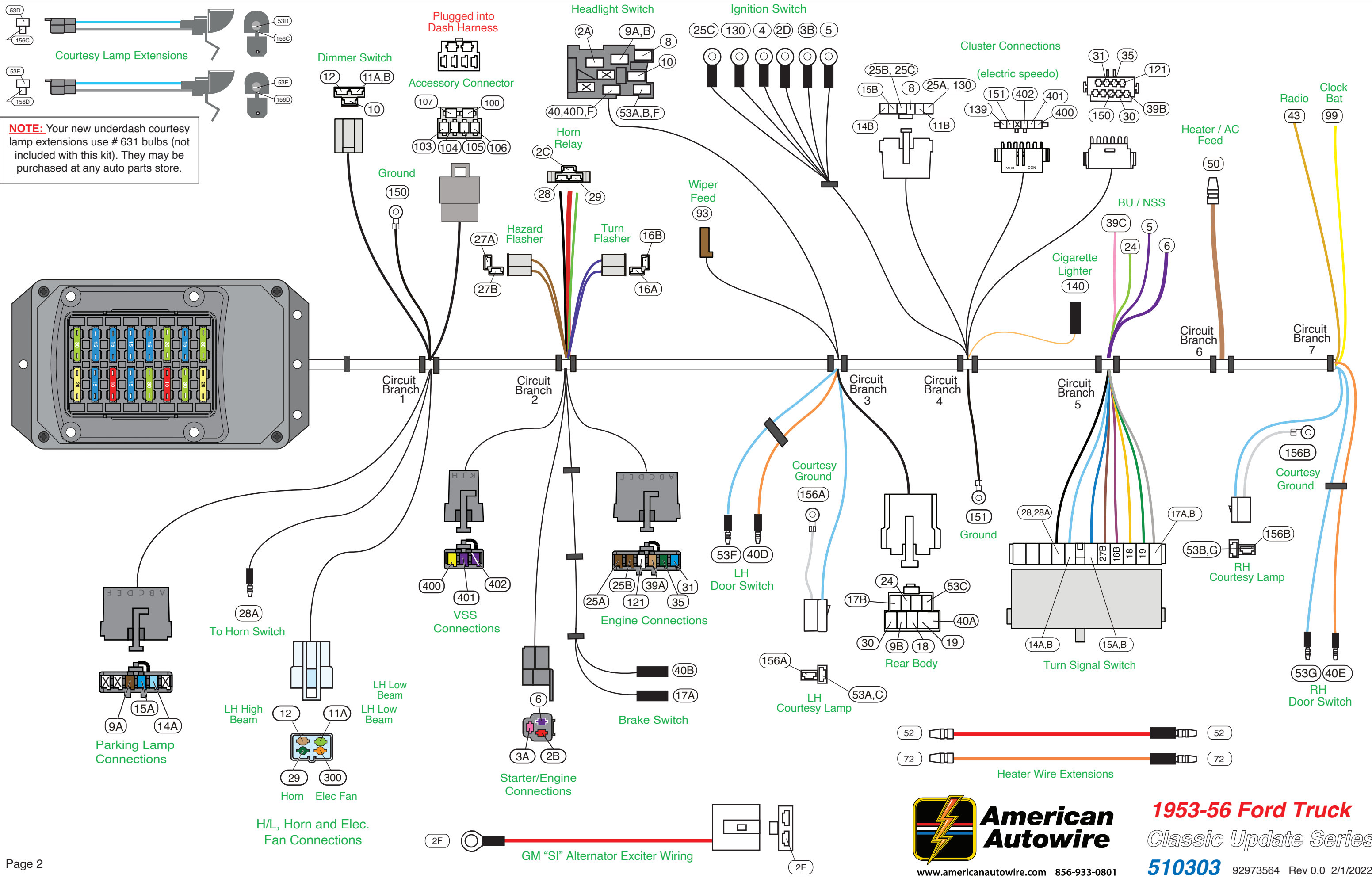

**NOTE:** Your new underdash courtesy lamp extensions use # 631 bulbs (not included with this kit). They may be purchased at any auto parts store.



**Main Fuse Panel Installation Instructions**

The Main Fuse Panel harness is designed to be mounted under the dash on the firewall in an area close to the steering column. See page 8 for a photo of the fuse panel as installed in our test truck. The enclosed representation of the main dash harness shows each circuit branch and identifies each connection by its color and function. Follow this drawing and detail drawings on pages 7, 8, 9, and 10 for the individual circuit connections.

**Circuit Branch 1 - Front Lighting connections**

Plug the 510905 Front Light Extension harnesses onto the dash at this location and bring the wires through the firewall as shown on page 9. See page 9, "Figure A" for typical connections. For loose piece terminals and connectors, see kit # 510312.

Wire #	Wire color	Printing
29	Dark Green	Horn
14A	Light Blue	Left Front Turn
15A	Dark Blue	Right Front Turn
300	Orange	Electric Fan
9A	Brown	Park Lights
11A	Light Green	Headlight-Hi Beam
12	Tan	Headlight-Low Beam
28A	Black	Horn Ground

**Procedure**

Connect to the horn power terminal. NOTE: If your horn has a separate ground terminal, you must supply the wire for this ground terminal as it is not included in the kit.  
 Connect to the left front directional lamp socket. If you are using a single front directional light with an 1157 or dual filament bulb, this wire would be connected to the high intensity filament of the LH front parking light.  
 Connect to the right front directional lamp socket. If you are using a single front directional light with an 1157 or dual filament bulb, this wire would be connected to the high intensity filament of the RH front parking light.  
 This is the 12 volt ignition feed to be connected to the trigger wire on your electric fan relay.  
 Connect to both the front park / running light sockets. If you are using a single front directional light with an 1157 or dual filament bulb, this wire would be connected to the low intensity filament of each of the front running lights. An in-line splice of this wire or a double up of this wire at the left front parking lamp will be necessary to accommodate the wiring of both of the front parking lights.  
 Select the light green Headlight Hi Beam wire (11A) and tan Headlight Low Beam wire (12). Route and connect these wires to the headlights. An in-line splice of these wires or a double up of these wires at the left front headlight then over to the right front headlight will be necessary to accommodate wiring of both of the headlights. Using the supplied terminals and connectors in kit 510265, connect these wires into the headlight ground wire and connector assemblies "A" found on pages 1 and 9. Specific connection and orientation for this process can be found in the diagram on page 9, Figure A.  
 This wire plugs into the stock horn ground wire coming out the bottom of a stock 1953-1956 Ford column. If you are using a later or aftermarket steering column such as Ididit, this wire will not be used, and the terminal should be cut off or insulated and taped back so it does not reach ground. If it were inadvertently grounded, your horn would blow continuously.

**Circuit Branch 1 - Underdash Connections**

Wire #	Wire color	Printing
10	yellow	Dimmer Switch Feed
11A, B	Light Green	Headlight Hi Beam
12	Tan	Headlight Low Beam

12v Feed from H/L switch  
 Switched 12v from dimmer to high beam lamps  
 Switched 12v from dimmer to low beam lamps  
 Use the provided connector J and terminals as power leads for the following:

**Accessory Wire Connector**

Fuse	Rating	Wire #	Wire color	Printing
FUEL	20 amp	103	Tan	Fuel Pump
PWRSEATS	30 amp	104	Orange	Power Seats
PWR LOCKS	15 amp	105	Red	Power Locks
CB	15 amp	100	Red	CB Radio
PWRWDO	30 amp	106	Pink	Power Window
BAT SPARE	30 amp	107	Orange	Spare Battery

Attach this wire to a good known chassis ground. (Note: Do not attach this wire with the 151 wire on page 4)  
 Chassis ground for instrument cluster connections.

**Circuit Branch 2 - Engine and Alt. connections**

Plug the 510906 Engine Extension harnesses onto the dash at this location and bring the wires through the firewall as shown on page 10. See page 10, "Figures C and D" for typical connections. For loose piece terminals and connectors, see kit # 510312. You will need to install the 25A, 25B, or 121 wires into the 510906 for your application.

Wire #	Wire color	Printing
6	Purple	Starter Solenoid-S
3A	Pink	Ignition Feed - coil
2B	Red	12 V Battery
2	Red	(No Printing)

Connect the end that comes out with the heavy red power wire to the "S" terminal on your starter solenoid. (See Figure D)  
 This is your 12 volt switched power source for the distributor. This can be connected directly to the "bat" terminal on a typical HEI distributor, to a ballast resistor as in a points type distributor, or be used as the ignition power source for an aftermarket ignition module such as an MSD or "Duraspark" module. See the installation instructions for the type of distributor you are using for specific connection requirements (See page 10 for some examples).  
 Route the red 12V Battery wire (circuit 2B) which is in the Dash Harness, to the Megafuses (see Figure D on page 10) and cut to length. Use ring terminal, shrink tubing from 510476 kit. Connect as shown on page 10.

Obtain the large red **Alternator Feed Wiring** from the 510476 kit and connect as shown on page 13 and on the instructions for the 510476 Alternator and Main Power Connection kit.

**NOTE: If you are using a one wire alternator, neither the 25A nor the 25B wires will be used, so tape these wires back to the trunk of the harness.**

25A	Brown	Alternator Ign
25B	Brown	Alternator Ign
31	Dark Blue	Oil Pressure Sender
35	Dark Green	Water Temp Sender
39A	Tan	Electric Choke
121	White	Coil - Tach

This wire is the exciter wire for your GM "SI" alternator / voltage regulator and it has a 10 ohm resistance on it.  
 This wire is the exciter wire for your Ford alternator / voltage regulator. It DOES NOT have any resistance on it as many of the Ford regulators already have an internal resistor. If the Ford or other alternator / regulator that you are using needs a resistor in-line on the feed wire, you will have to supply it per the specs of that alternator (AAW recommends a GEN 3 Internally Regulated [AAW p/n 500802 available separately] or 1 wire unit).  
 Connect to the oil pressure sender.  
 Connect to the temperature sender.  
 On carbureted cars, connect to the electric choke terminal.  
 This can be connected directly to the tach terminal on a typical HEI distributor, to the negative side of the coil, or a tach connection in an aftermarket ignition module such as an MSD module. See the installation instructions for the type of ignition system you are using for specific connection requirements.

**VSS Connection:** These wires and connector are for use with an aftermarket electric speedometer only. The VSS Lead Wires, 510730, bag V, will plug in here. Refer to that instruction sheet for wire functions and additional directions.

**Brake Switch Connections**

40B	Orange	12v Battery Fused
17A	White	Brake Switch

Connect to either post on the brake switch.  
 Connect to the opposite post on the brake switch

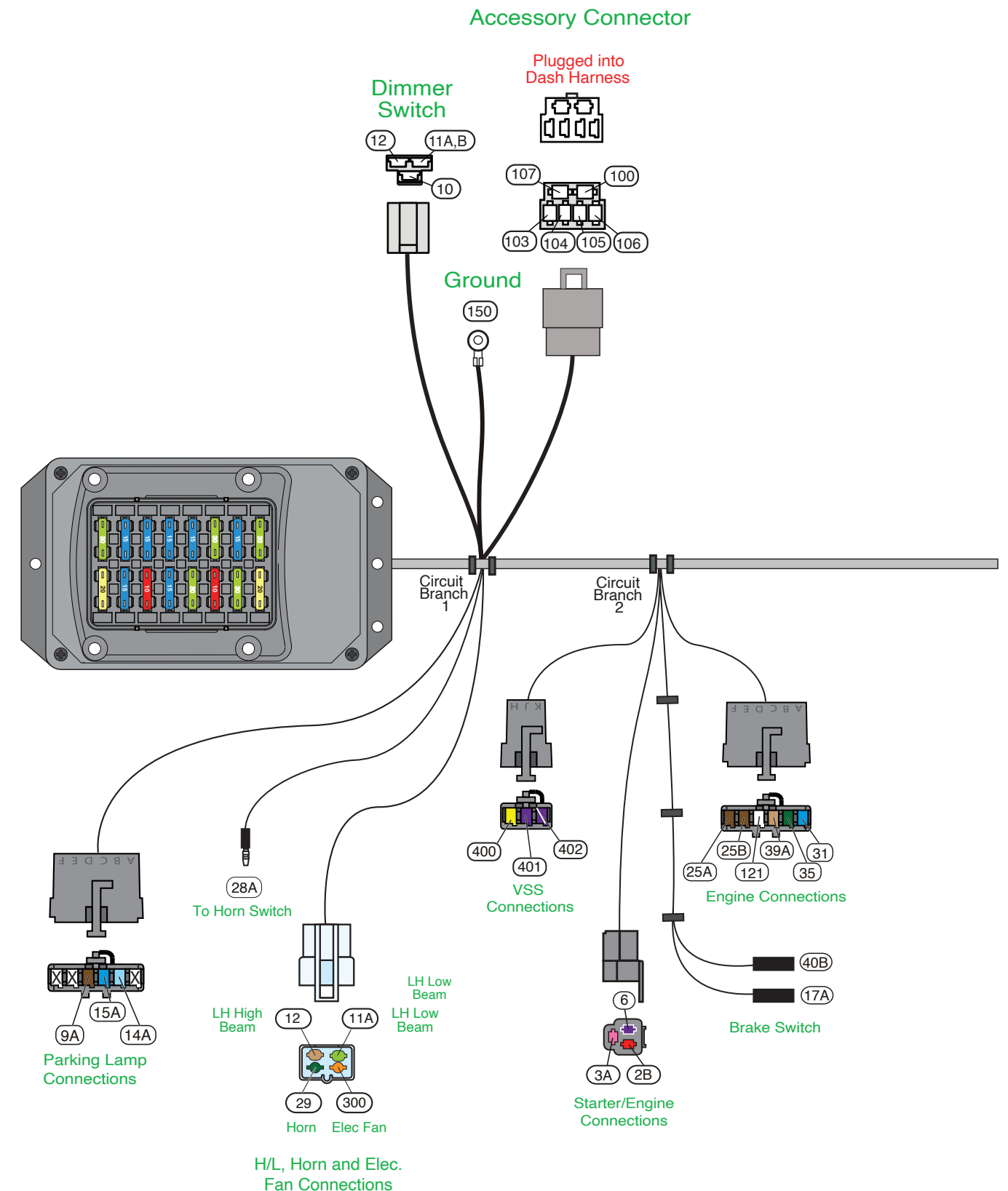

www.americanautowire.com 856-933-0801

**1953-56 Ford Truck**  
 Classic Update Series

**510303** 92973564 Rev 0.0 2/1/2022

**Circuit Branch 2- Underdash Connections**

Wire #	Wire Color	Printing
Horn Relay		
2C	Red	12v Bat
28	Black	Relay Ground
29	Green	Horn
Flashers		Plug one each of the flasher cans (found in the 510145 fuse kit) into these connections.
16, 16A	Purple	Turn Switch Feed
27, 27A	Brown	Turn Sw Hazard

**Procedure**  
 Plug the horn relay (found in the 510145 fuse kit) into this connector.  
 12 volt battery feed.  
 Relay ground circuit (to steering column).  
 Triggered 12 volts to horn.  
 Turn signal flasher leads.  
 Hazard flasher leads.

**Circuit Branch 3 - Underdash Connections**

Wire #	Wire Color	Printing
Rear Body Connection		

**Procedure**  
 This connector will plug into the Rear Body Kit, 510263. Specific connections are addressed in that kit. These wires will pass out to the engine bay through the firewall at the Front Light Location as seen on page 9, Figure A.

9B	Brown	Rear Running Lights
17B	Lt. Blue	Third Brake Light
18	Yellow	Left Rear Turn
19	Dk. Green	Right Rear Turn
24	Lt. Green	Back Up Lt Sw
30	Tan	Gas Gauge
40A, C	Orange	12v Battery Fused
53C	Lt. Blue	12v Ctsy Sw
LH Courtesy Connection		
53A, C	Lt. Blue	12v Ctsy Sw
156A	White	Ctsy Ground
LH Door Jamb Switch		
53F	Lt. Blue	12v Ctsy Sw
40D	Orange	12v Battery Fused
Lighting Switch		
2A	Red	12v Bat
8	Gray	Dash Lights
9A, B	Brown	Park Lights
10	Yellow	Dimmer Sw Feed
40	Orange	12v Battery Fused
53A, C	Lt. Blue	12v Ctsy Sw
Wiper Switch Feed		
93	White	Wiper Feed

12v feed for tail and tag lamps.  
 12v feed for optional 3rd brake lamp.  
 12v feed to the LH rear stop and turn lamp.  
 12v feed to the RH rear stop and turn lamp.  
 12v feed to the back up lamps (if so equipped).  
 Fuel sender signal wire between the rear body and cluster connections.  
 12v battery feed for LED lamps.  
 12v switched feed from the lighting switch to the rear body harness for the dome lamp.  
 Plug in 1 Courtesy lamp extension (as found on page 2 of this instruction set) to complete this circuit.  
 Switched 12 volt power for LH underdash courtesy lamp.  
 LH underdash courtesy ground.  
 Switched 12 volt power for LH door jamb switch to dome and courtesy lamps.  
 12v battery feed to LH door jamb switch.  
 Plug this connector onto lighting switch 500264.  
 Unfused 12v battery feed to the lighting switch for headlamps, tail lamps, and dash illumination lamps.  
 Feed out to dash illumination lamps at cluster.  
 Feed out to front parking and rear tail lamps  
 Feed to headlight dimmer switch for headlights.  
 Secondary fused 12v battery feed to lighting switch for courtesy and dome lamps.  
 Switched 12 volt power from lighting switch to dome and underdash courtesy lamps.  
 This is your 12v feed only only. This feed must be reused in conjunction with your original wiper switch to motor and / or pump harness.  
 12v fused feed for wiper switch assembly.

**Circuit Branch 4 - Underdash Connections**

Wire #	Wire color	Printing
Ignition Switch		
2D	Red	12v Bat
3B	Pink	Ignition Feed
4	Brown	Ignition Sw Accessory
5	Purple	Neutral Safety Switch

**Procedure**  
 Attach each of the ring terminals to the appropriate stud on the ignition switch per the directions below.  
 Attach to "BAT" stud on the ignition switch. Unfused feed into ignition switch from the battery.  
 Attach to "IGN" stud on the ignition switch. Unfused ignition feed out to fuse panel and ignition system.  
 Attach to "ACC" stud on the ignition switch. Unfused accessory feed out to fuse panel.  
 Attach to "ST" stud on the ignition switch. Unfused start feed to the neutral safety switch.

25C	Brown	Alternator Ign
130	Brown/White	

**NOTE: If you are using a one wire alternator, neither the 25C nor the 130 wires will be used, so just tape them back to the trunk of the harness.**

Alternator regulator exciter connection from "ACC" on the ign. switch to cluster and regulator at alternator. **NOTE:** This wire attaches to the "ACC" stud on the ignition switch and is ONLY used on a Ford Style alternator / regulator where there is no resistance feed necessary as the regulator usually has an internal resistor.  
 Alternator regulator exciter connection from "ACC" on the ign. switch to cluster and regulator at alternator. **NOTE:** This wire attaches to the "ACC" terminal on the ignition switch and is used ONLY when a GM Style alternator / regulator will be used where there is a 10 Ohm resistance feed necessary to excite the regulator circuit.

**Speedometer Cluster Connections**

25B,C	Brown	Alternator Ign
25A/130	Brown	Alternator Ign
8	Gray	Dash Lights
11B	Lt. Green	Hi Beam Indicator Light
14B	Lt. Blue	Left Turn Ind
15B	Dk. Blue	Right Turn Ind
30	Tan	Gas Gauge
31	Dk. Blue	Oil Pressure
35	Dk. Green	Temp Sender
39B	Pink	12v Ign Fused
121	White	Coil Tach
139	Pink/White	Speedo Power
150	Black	Ground
151	Black	Ground
400	Yellow	VSS Ground
401	Purple	VSS Signal
402	Purple/White	VSS Power
Cigarette Lighter		
140	Orange	12v Battery Fused
Ground Lead		
151	Black	Ground

These connections will plug into the Cluster Connection Kit, 510307. Specific connections are addressed in that kit.  
 12v accessory feed to the cluster and alternator regulator with Ford alternator (no resistance).  
 12v accessory feed to the cluster and alternator regulator with GM alternator (10 Ohm resistance).  
 Feed out from the lighting switch to the dash cluster for dash illumination lamps.  
 12v feed to dash cluster for high beam indicator lamp.  
 12v feed to dash cluster for left front turn indicator lamp.  
 12v feed to dash cluster for right front turn indicator lamp.  
 Fuel sender signal from rear body harness connection to cluster connection.  
 Oil pressure signal from engine harness lead to cluster connection.  
 Temperature sender signal from engine harness lead to cluster connection.  
 Fused 12v Ignition feed to cluster connection for any warning lamp or any 12v gauges (includes stock 56 gauges). If using your stock 53-5 gauges, you will need to run a resistor to knock the voltage down to 6 volts.  
 Tach sender signal wire from engine harness lead to the cluster connection.  
 Fused 12v Ignition feed to the cluster connection for electric speedometer.  
 Gauge cluster ground to cluster connections.  
 Electric speedometer ground to cluster connections.  
 VSS ground from engine harness to cluster connections for electric speedometer.  
 VSS signal from engine harness to cluster connections for electric speedometer.  
 VSS 12v fused power from cluster connections to engine harness leads for electric speedometer.  
 Plug this connection onto your original lighter socket assembly.  
 12v battery feed for the cigarette lighter.  
 Attach this wire to a good known chassis ground. (Note: Do not attach this wire with the 150 wire on page 3)  
 Chassis ground for electric speedometer at instrument cluster connection.

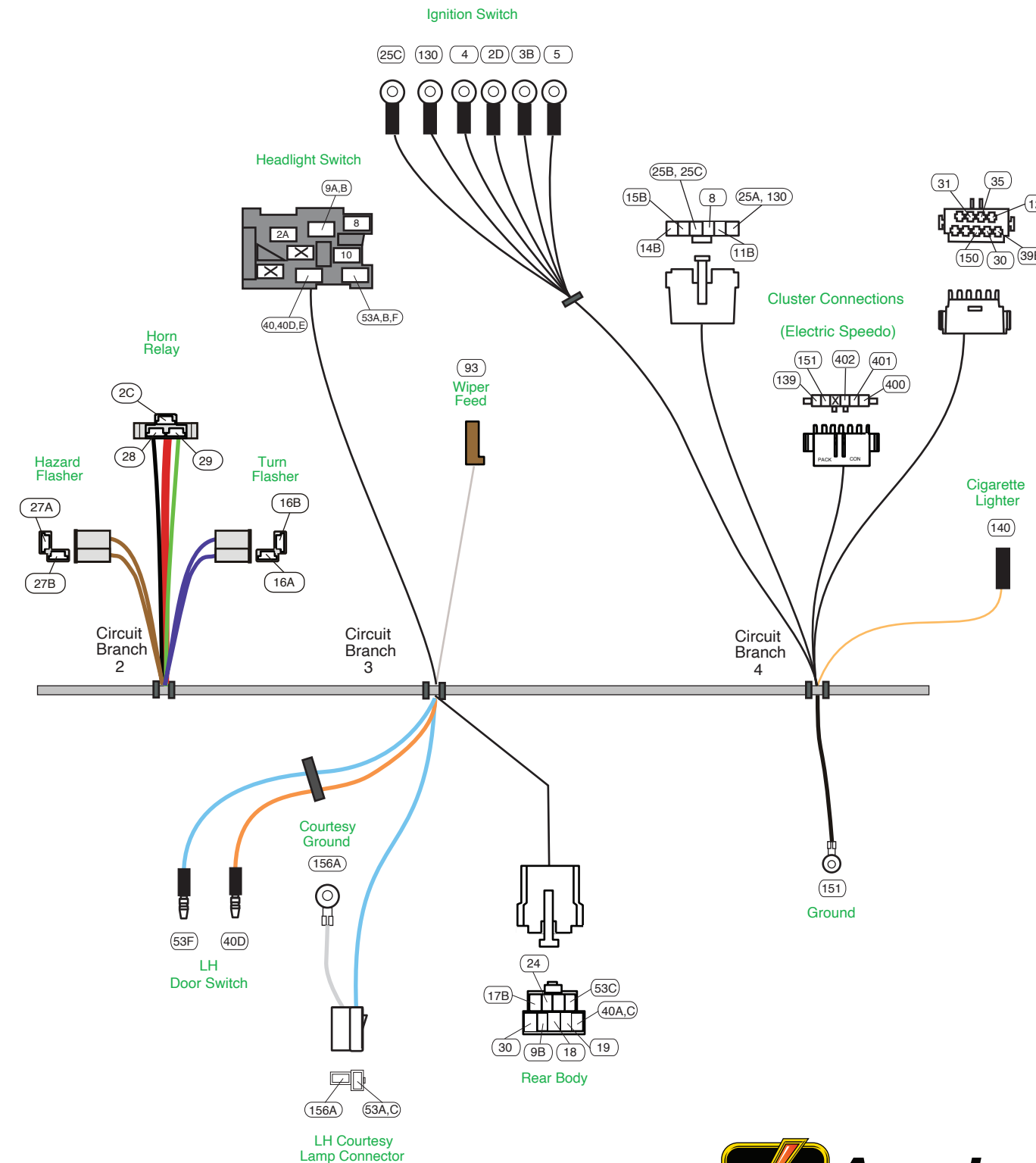

**NOTE:** The courtesy lamp extension from page 2, that plugs onto the connector at branch 3 on this page, uses a # 631 bulb (not included with this kit). They may be purchased at any auto parts store.



www.americanautowire.com 856-933-0801

**1953-56 Ford Truck**  
 Classic Update Series  
**510303** 92973564 Rev 0.0 2/1/2022

TYPICAL BLADE TYPE GAUGE CONNECTIONS

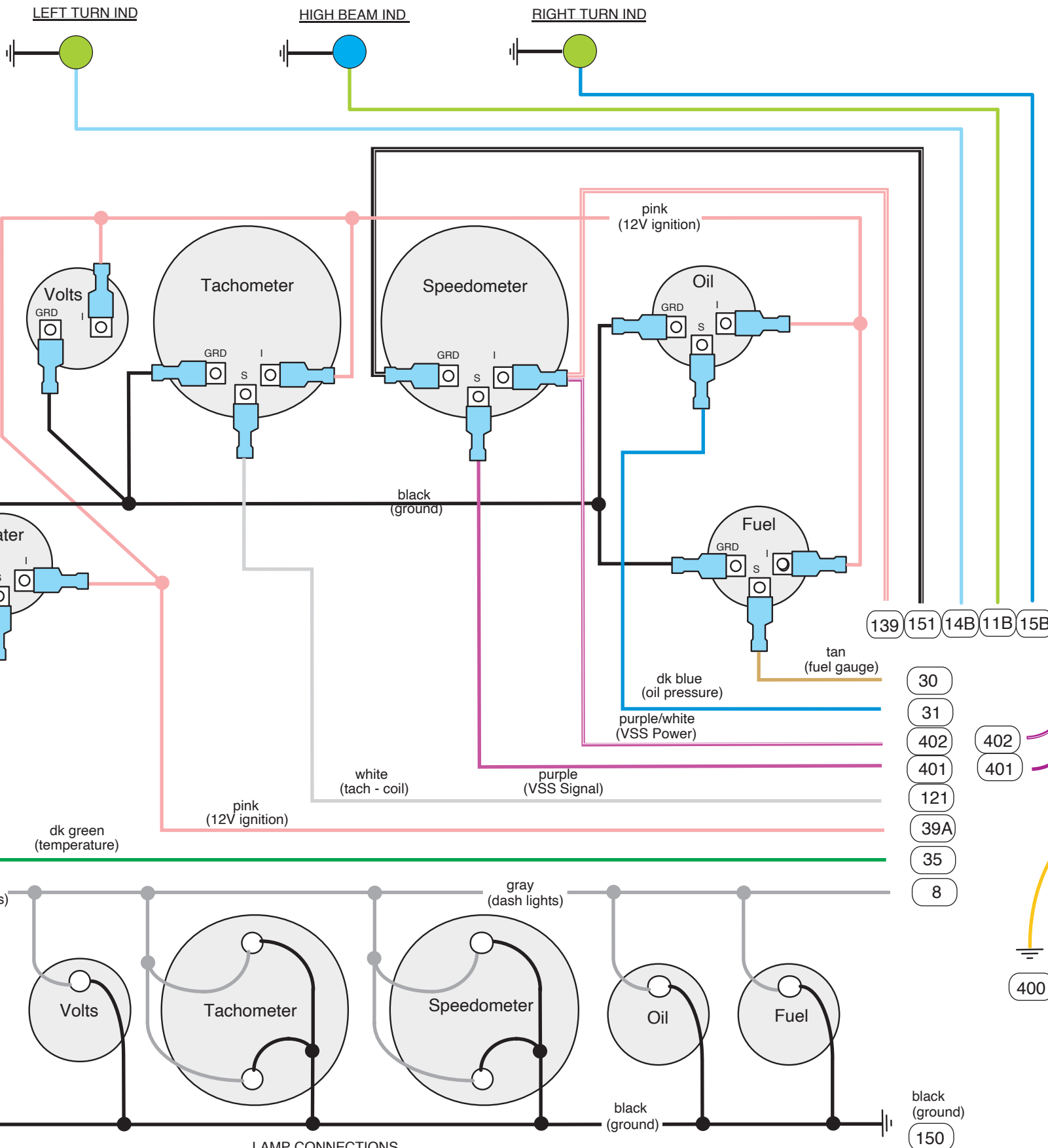

LAMP CONNECTIONS

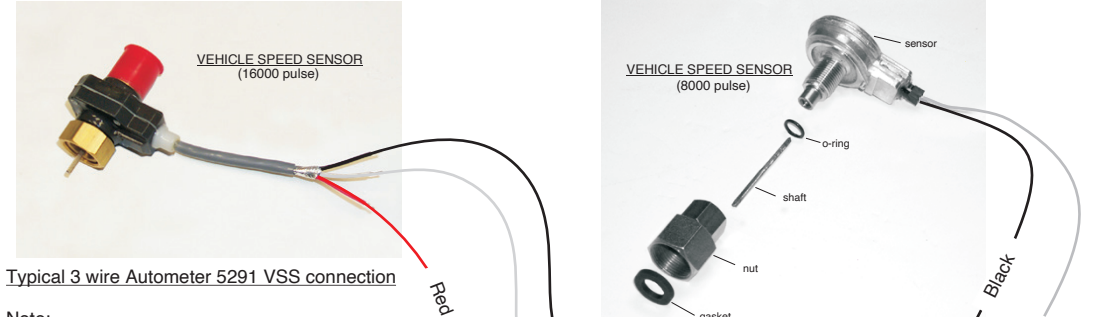
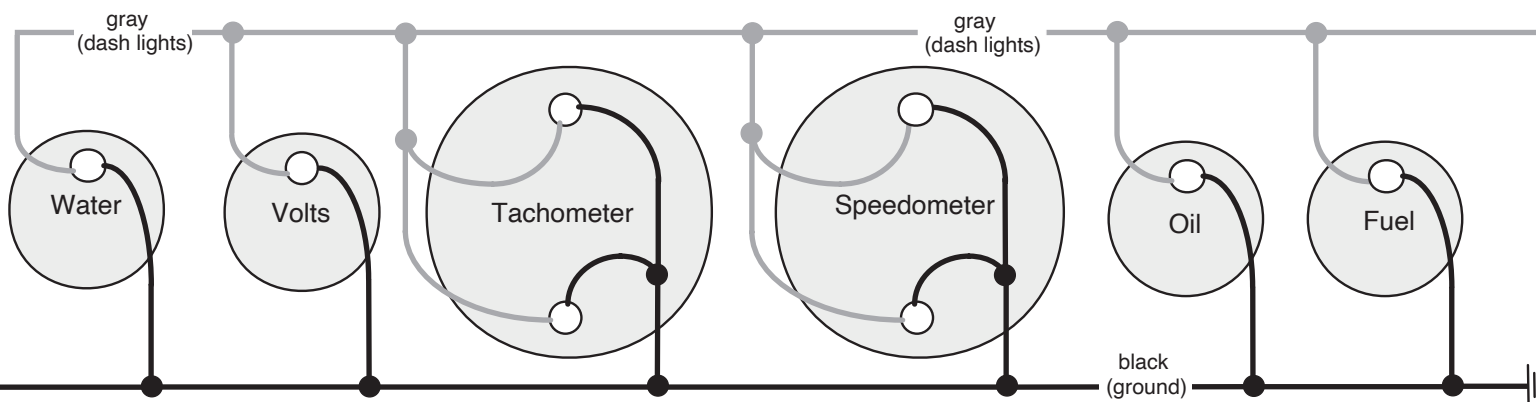

Typical 3 wire Autometer 5291 VSS connection  
Note: This VSS requires a lead wire from the red wire to a 12 volt ignition source. This wire is not included in the kit.

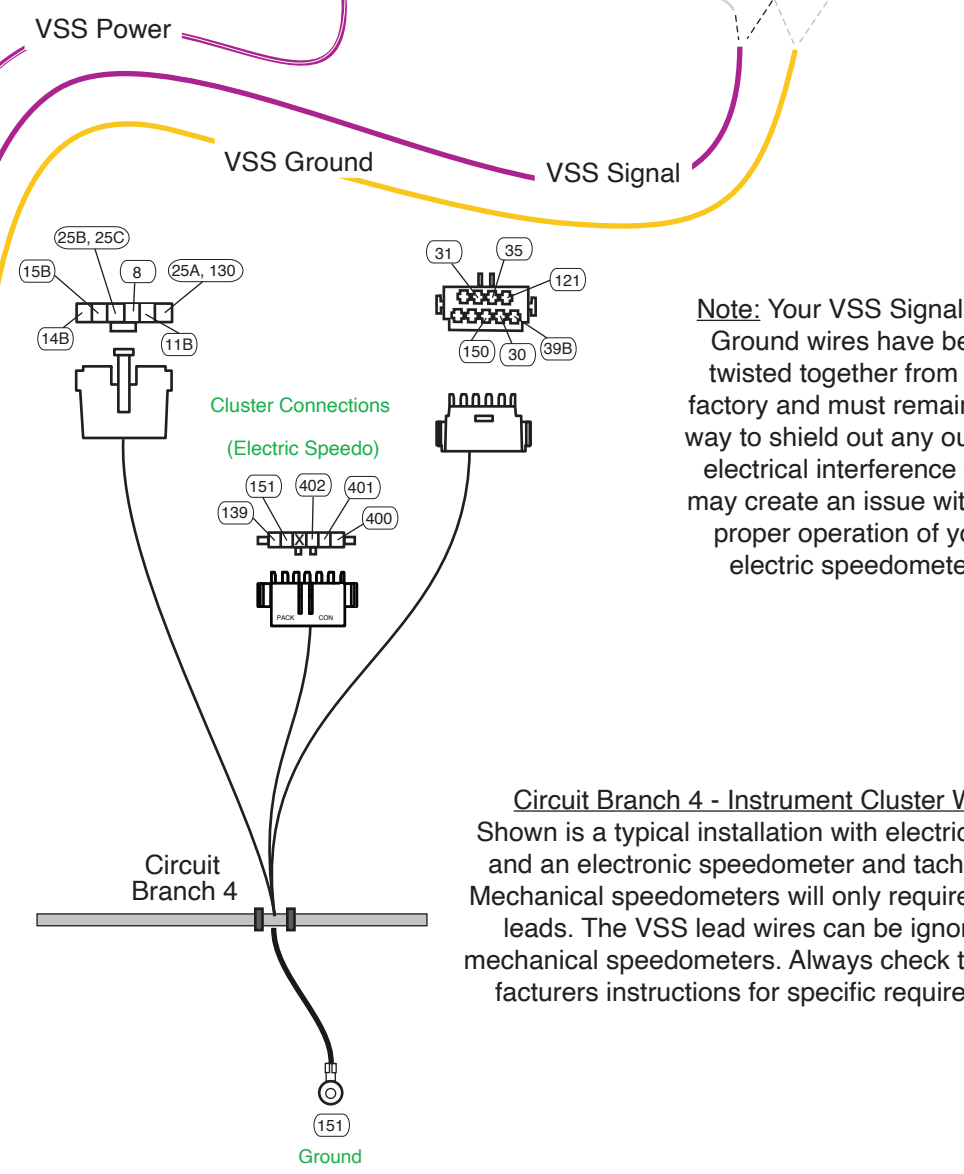

Note: Your VSS Signal and Ground wires have been twisted together from the factory and must remain this way to shield out any outside electrical interference that may create an issue with the proper operation of your electric speedometer.

Circuit Branch 4 - Instrument Cluster Wiring  
Shown is a typical installation with electric gauges and an electronic speedometer and tachometer. Mechanical speedometers will only require the light leads. The VSS lead wires can be ignored for mechanical speedometers. Always check the manufacturer's instructions for specific requirements.



Main Fuse Panel Installation Instructions

**Circuit Branch 5 - Underdash Connections**

Wire #	Wire Color	Printing
24	Lt. Green	Back Up Lt Sw
39C	Pink	12v Ign Fused
5	Purple	Neutral Safety Sw
6	Purple	Starter Solenoid

**Procedure**

A typical connection for your neutral safety and back up switch can be found on page 10, "Figure E".  
 Switched feed from back up lamp switch to rear body connection.  
 12v ignition feed to back up lamp switch.  
 12v feed from solenoid post on the ignition switch to neutral safety switch.  
 12v starter solenoid feed out to engine connections from neutral safety switch.

**Turn Signal Switch Connection**

Plug into steering column turn signal connection. If you are using a stock '56 Ford steering column on your vehicle, refer to Diagram 'A' and "Table "A" - AAW turn signal wires to stock turn signal switch wires" on page 8 for proper mating directions. We have also addressed the use of the aftermarket clamp-on style turn signal switch assemblies on page 8 as well. This kit is designed to function with a GM style turn signal switch. Our connector mates to a 3 7/8 inch long plug used on 1969-1974 GM, IDIDIT, and many other aftermarket steering columns. Starting from 1975 on up, the GM switch changed and began using a 4 1/4 inch connector. That connector is from the same family and uses the same terminals. By using the supplied mating connector (L) and terminals (M) located in the loose piece kit bag of this dash harness (510889), it is easy to adapt any steering column to the kit. The function of the wires are as follows:

14A, B	Lt. Blue	Left Front Turn
15A, B	Dk. Blue	Right Front Turn
16B	Purple	Turn Switch Feed
17A	White	Brake Sw
17B	Lt. Blue	Third Brake Lt.
18	Yellow	Left Rear Turn
19	Dk. Green	Right Rear Turn
27B	Brown	Turn Sw Hazard
28, 28A	Black	Horn Relay Ground

LH front turn signal feed out to front light and dash cluster connections.  
 RH front turn signal feed out to front light and dash cluster connections.  
 Turn signal 12v feed into column from flasher.  
 12v input from brake switch to turn switch for rear brake lights.  
 12v feed for third brake light to rear body connector.  
 LH rear turn signal feed out to rear body connection.  
 LH rear turn signal feed out to rear body connection.  
 Hazard switch 12v feed into column from flasher.  
 Steering column horn ground to horn relay.

**Circuit Branch 6 - Underdash Connections**

Wire #	Wire Color	Printing
--------	------------	----------

**Procedure**

Note: We have provided you with loose piece wire assemblies as seen on page 2 that will connect from your stock heater switch to your stock blower motor. Detailed installation directions for these connections (wires 52 and 72) can be found on page 9, "Figure B".  
 This wire will plug onto your stock heater switch or can be used as the "on/off" power source for aftermarket A/C  
 12v switched feed for "on/off" power to your stock heater switch or aftermarket heat and A/C..

Heat and A/C Feed		
50	Brown	Heater AC Feed

**Circuit Branch 7 - Underdash Connections**

Wire #	Wire Color	Printing
RH Courtesy Connection		
53B	Lt. Blue	12v Ctsy Sw
156B	White	Ctsy Ground
RH Door Jamb Switch		
53G	Lt. Blue	12v Ctsy Sw
40E	Orange	12v Battery Fused

**Procedure**

Plug in 1 Courtesy lamp extension (as found on page 2 of this instruction set) to complete this circuit.  
 Switched 12 volt power for RH underdash courtesy lamp.  
 RH underdash courtesy ground.  
 Switched 12 volt power for RH door jamb switch to dome and courtesy lamps.  
 12v battery feed to RH door jamb switch.

Wire #	Wire Color	Printing
Radio/ Clock Connections		
43	Tan	Radio
99	Yellow	Clock Battery

12v fused accessory feed for radio "on/off" power.  
 12v fused battery feed for radio clock and memory or dash clock assembly.

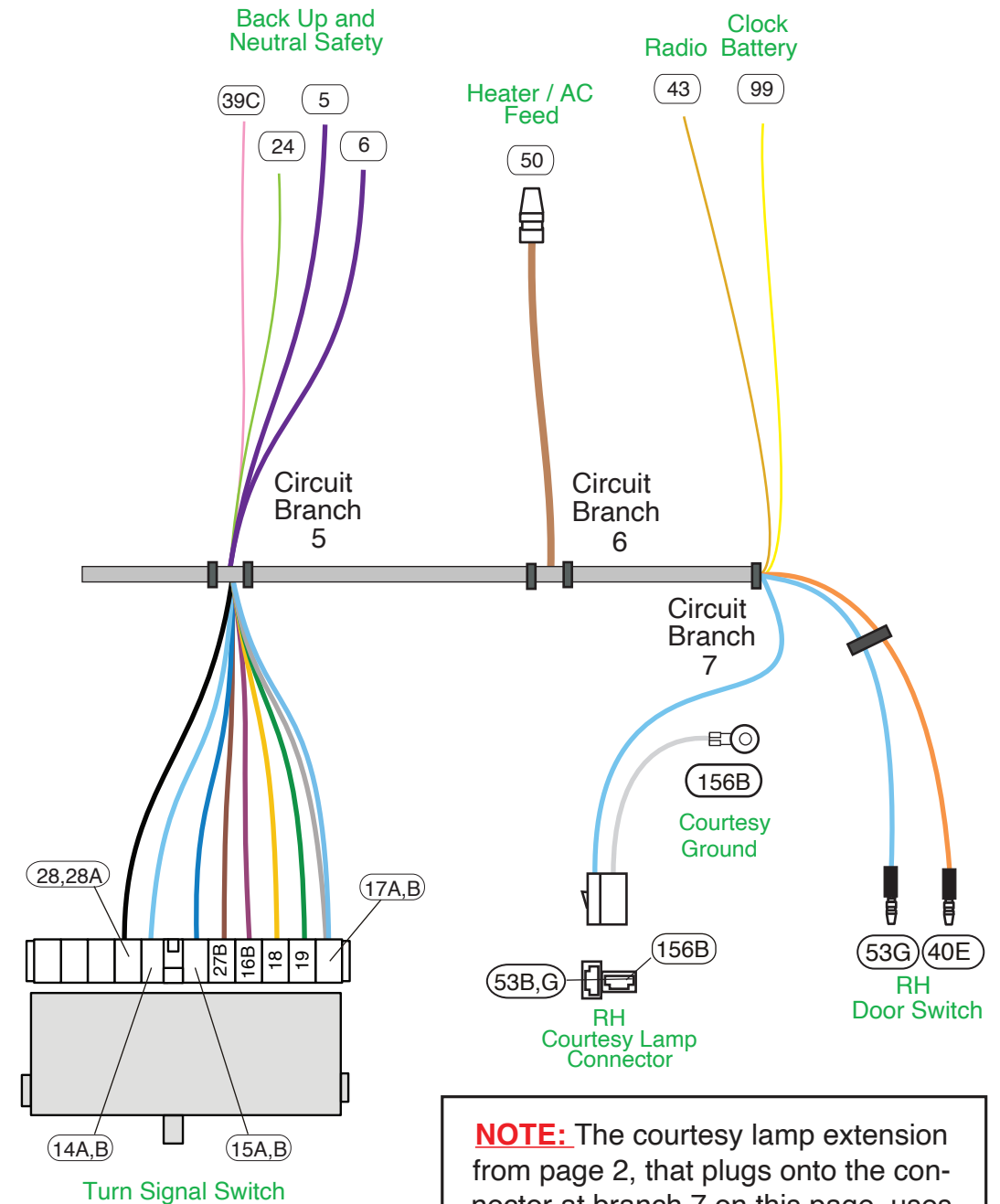

**NOTE:** The courtesy lamp extension from page 2, that plugs onto the connector at branch 7 on this page, uses a # 631 bulb (not included with this kit). They may be purchased at any auto parts store.

## Stock Firewall Harness Pass Thru Grommet

## As Viewed From Under the Hood

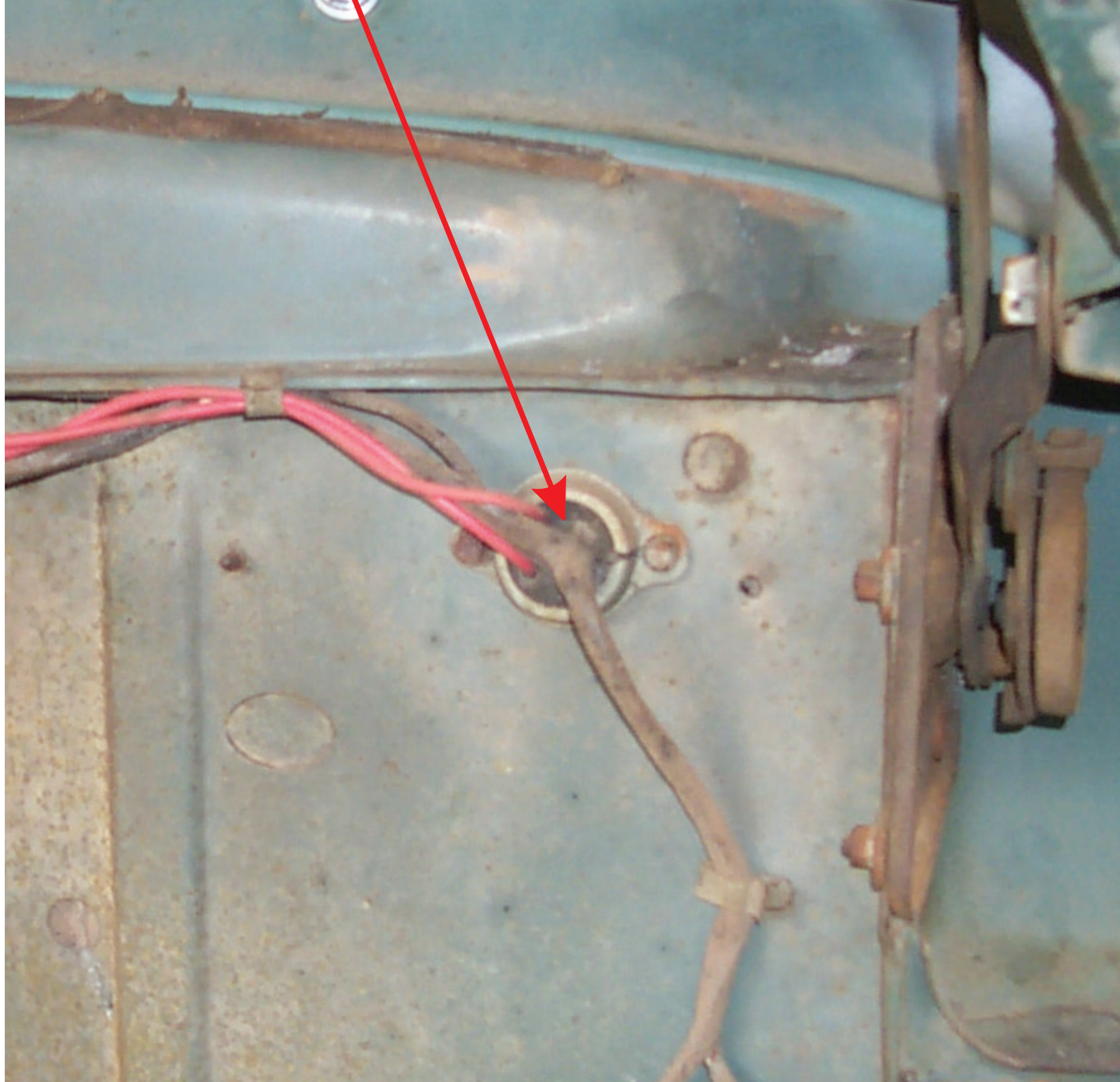

NOTE: On this page, you will find a photograph of the stock firewall of our test vehicle. We have provided you with a new reproduction firewall pass thru grommet, but not the retainer. There are many different styles (raw stamped, plated, billet, etc.) of the retainer, so we have left that option to the builder's taste. The grommet has 1 large pierced hole and 2 smaller holes that are not pierced. Your new harness has been designed so that the forward lamp and engine wiring will pass thru this area. If you opt to route all your wires thru this grommet, you will need to open these holes up more as there are many new wires in your new harness system. There is also sufficient length on the new harness for custom routing if you have closed this stock hole up and wish to route the wires out into the engine compartment in a different manner. See pages 9 and 10 for the specific connection and routing instructions of all your forward lamp, heater, and engine wiring.



# FUSEBOX MOUNTING LOCATION UNDER DASH, TO LEFT OF STEERING COLUMN

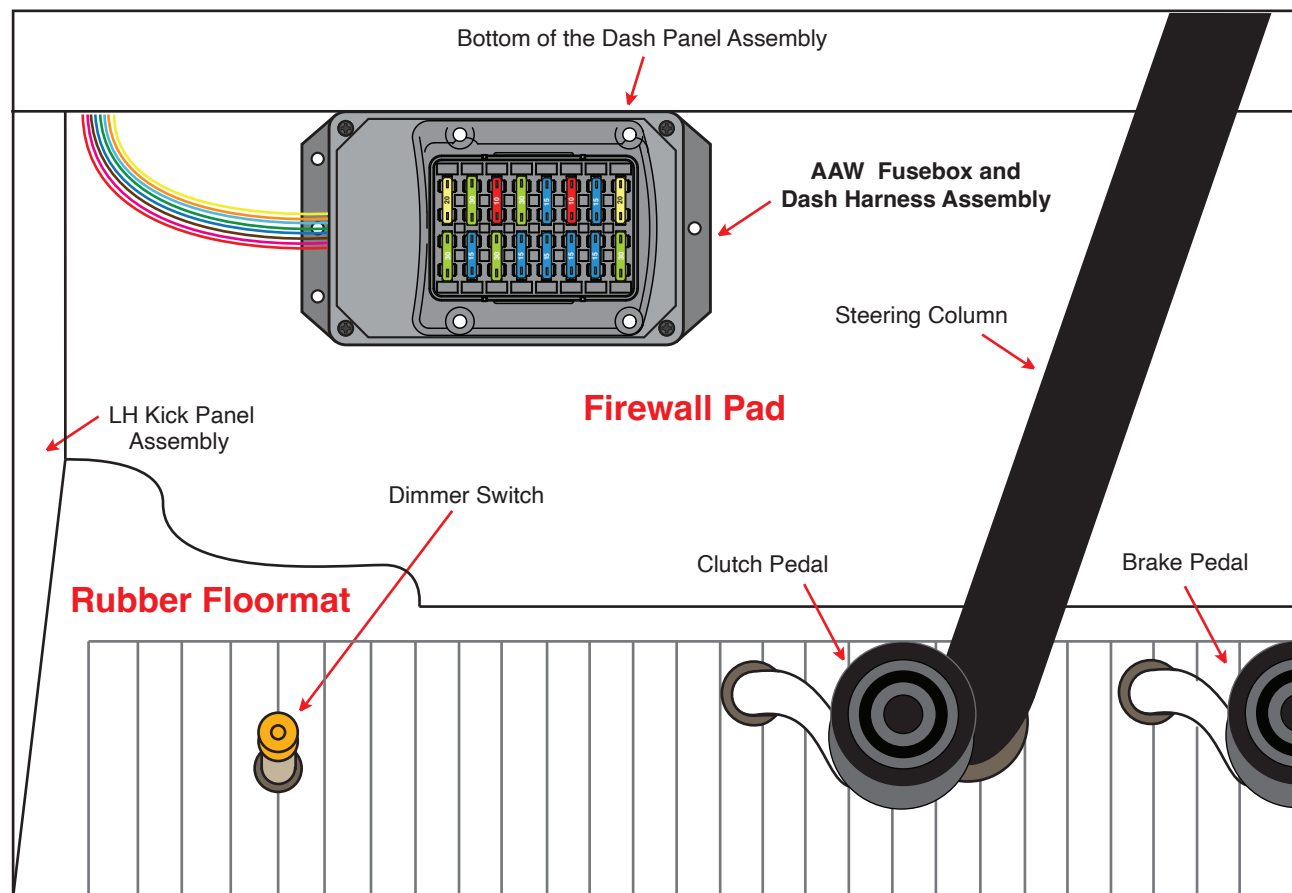

**NOTE:** The installation and placement of the new fusebox is not extremely critical for this application. On this page, you will find a drawing of the completed fusebox and dash harness assembly as it would install in your vehicle. The harness is long enough that you just need to mount the fusebox as the drawing depicts. As long as the fusebox assembly is installed in the general area as shown, the harness will install fine. Once the fusebox has been attached to the firewall of the truck, the harness routes up into the upper LH corner of the underdash area, then continues on over top and behind the dash cluster assembly. Please take time to keep it away from any moving items such as the wiper motor linkage and the pedals if you're are using a hanging pedal set. We have provided 2 attaching screws for you to affix the fusebox to the firewall. They can be found in the 510889+ loose piece dash kit.

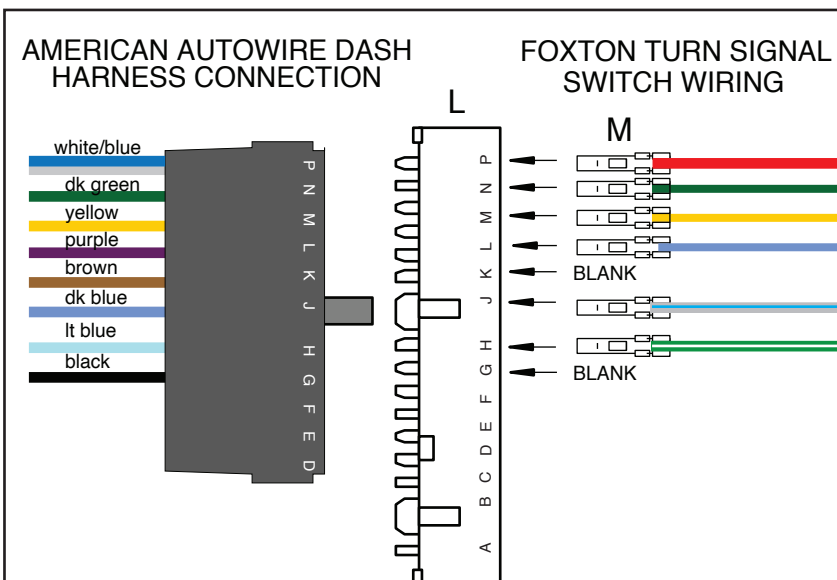

**DIAGRAM 'A' - AAW Turn Signal  
Switch Wires to Stock 1956  
Steering Columns.**

## "Table A"

AAW Turn Signal Switch wires to stock  
"in-column" 1956 Ford Truck turn signal switch.

AAW Wire #	AAW Wire color	AAW Wire Printing	Ford Wire Color
14A,B	Light Blue	Left Front Turn	Green w/White Stripe
15A,B	Dark Blue	Right Front Turn	White w/Blue Stripe
16B	Purple	Turn Switch Feed	Blue
17A,B	White & Blue	Brake Switch	Red
18	Yellow	Left Rear Turn	Yellow
19	Dark Green	Right Rear Turn	Dark Green
27B	Brown	Turn Sw - Hazard	Not applicable
28, 28A	Black	Horn Relay Ground	Not applicable

**NOTE:** The stock 1953-55 Ford turn signal switch only switched 2 wires, not 4 as a modern system does. These switches are not available in reproduction, so in this instance, we will not address the stock 1953-55 turn signal switch. There are also many "over the counter" add on turn signal kits available from manufacturers such as Yankee and Foxton. If you are using one of those kits, simply use "Table A" above as a guide as to what wire serves which function on the AAW kit and then mate each wire from the AAW kit to the corresponding wire on your turn signal switch based on the function of each of those wires. For example, on the Foxton unit, the RH rear wire is a black wire which would get mated to our dark green RH rear turn wire. The LH rear turn on the Foxton unit is a dark blue wire which would get mated to our yellow LH rear turn wire, etc. Circuit 27B is being provided if an Emergency Warning Flasher System is to be added.

**PLEASE NOTE:** Our system is designed to use the stock individual LH and RH turn signal indicators in your dash cluster. It is suggested that you mate the "flasher input" signal wire on your add on unit to our purple wire. DO NOT use the flasher and pilot light unit along with the 3 pronged flasher that several of these units include. If you feel that you must use the flasher and pilot assembly assembly on your turn signal unit, you will have to mate that source wire to a separate ignition source such as the 100 wire found on page 3, branch 1, of this instruction set, 92973564. In that instance, our brown and purple wires from "Table A" above will not be used.



www.americanautowire.com 856-933-0801

**1953-56 Ford Truck**  
*Classic Update Series*

**510303** 92973564 Rev 0.0 2/1/2022

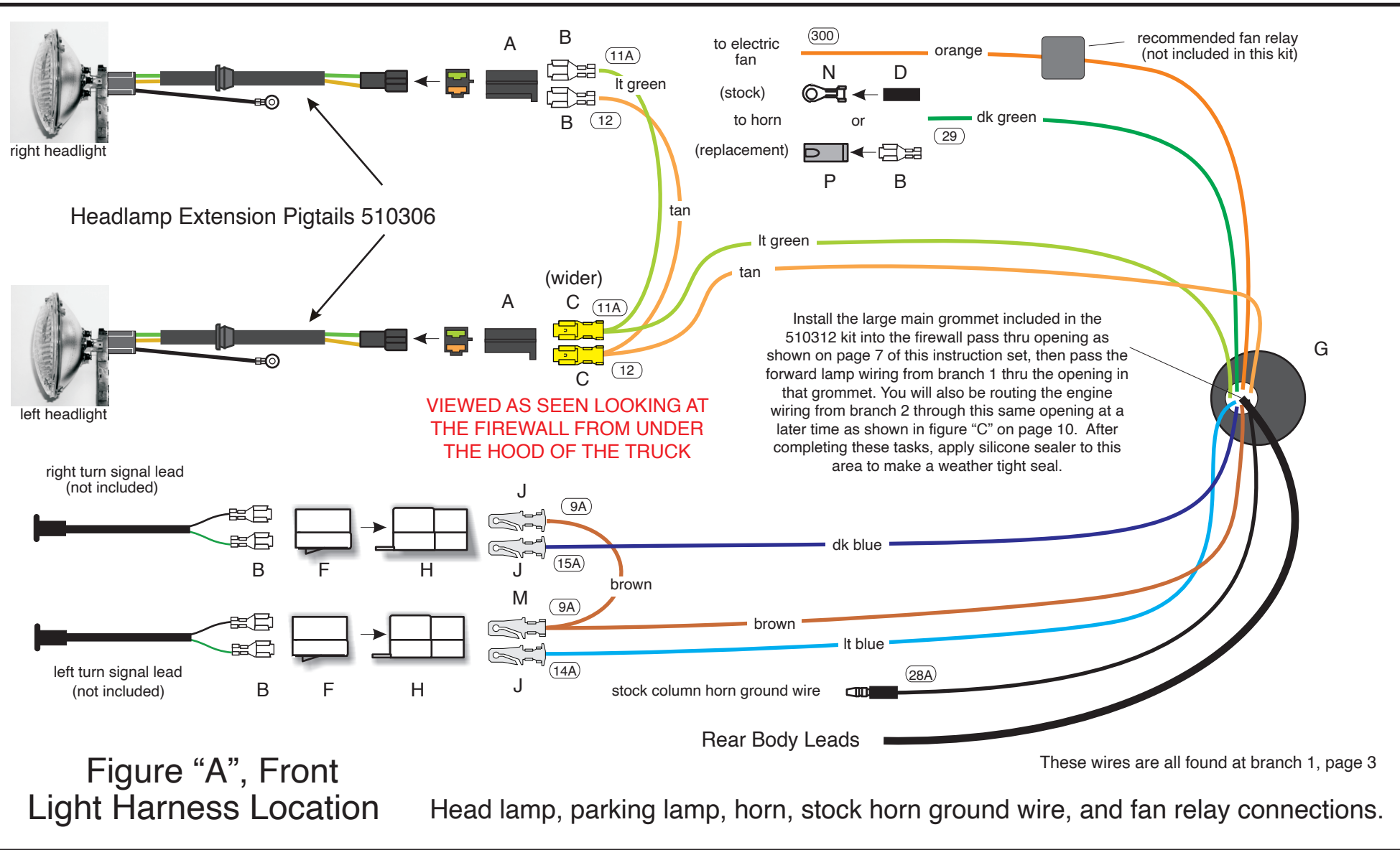

**NOTE:** The terminals and connectors listed on this page and denoted with **UPPER CASE LETTERS** to help you complete the various connections to your lamps, horns, switches, etc. can be found in your loose piece clamp, grommet, and parts kit, P/N 510312.

The identifications, colors, and functions for all of the wires listed in "Figures A and B" on this page can be found on pages 2, 3, and 6, branch 1 or branch 6 of this main instruction set (92973564). AAW suggests and recommends using pages 2, 3, 6, and 9 to complete the installation of the forward lamp and heater connections.

This AAW kit is engineered to work with most aftermarket manufacturer's heating and air conditioning systems. As such, we have provided a keyed 12-volt feed to use as the "OFF / ON" (AAW brown 50 wire) power source for whatever system you choose to purchase. The manufacturer will supply you with a harness for their system and instructions on how to connect it. In the event you are utilizing a stock heater system in your truck, we have also provided wires that will run from your heater switch to your heater motor. See "Figure B" below for complete installation instructions.

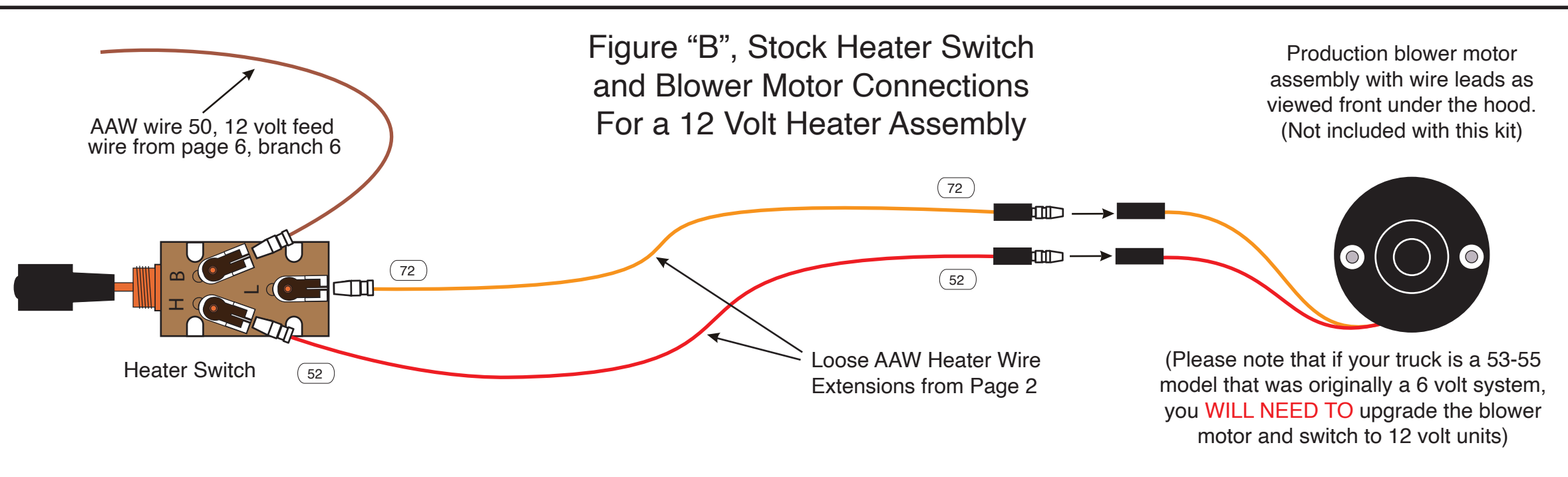

www.americanautowire.com 856-933-0801

**1953-56 Ford Truck**

*Classic Update Series*

**510303** 92973564 Rev 0.0 2/1/2022

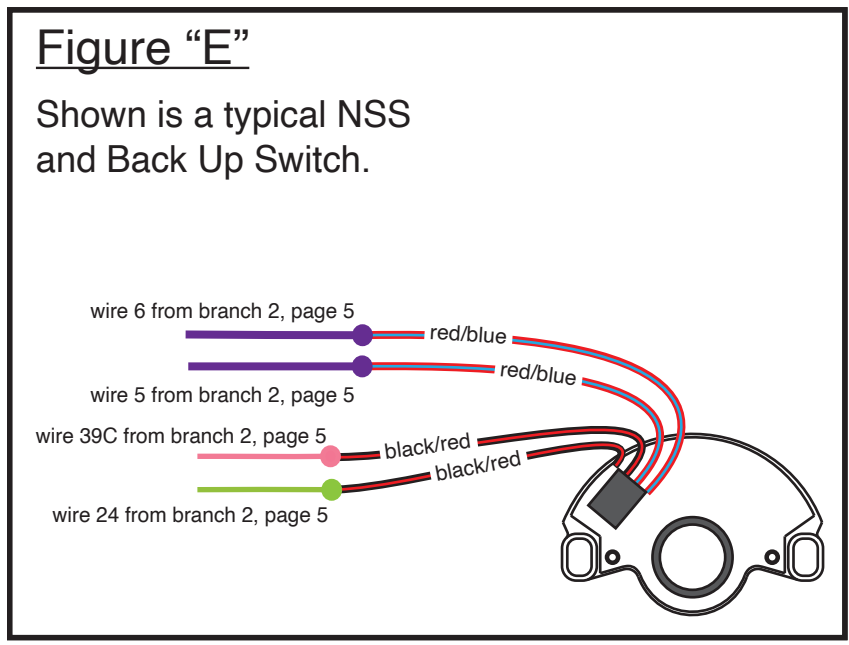
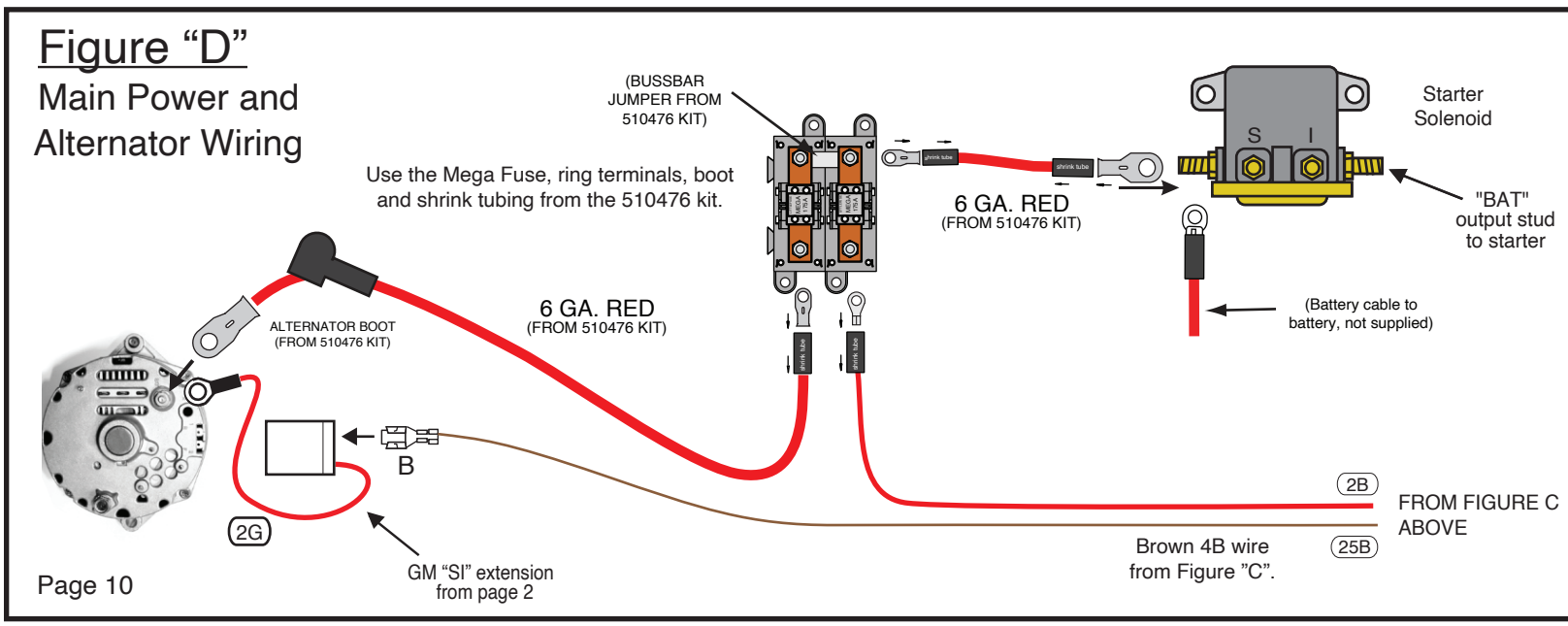
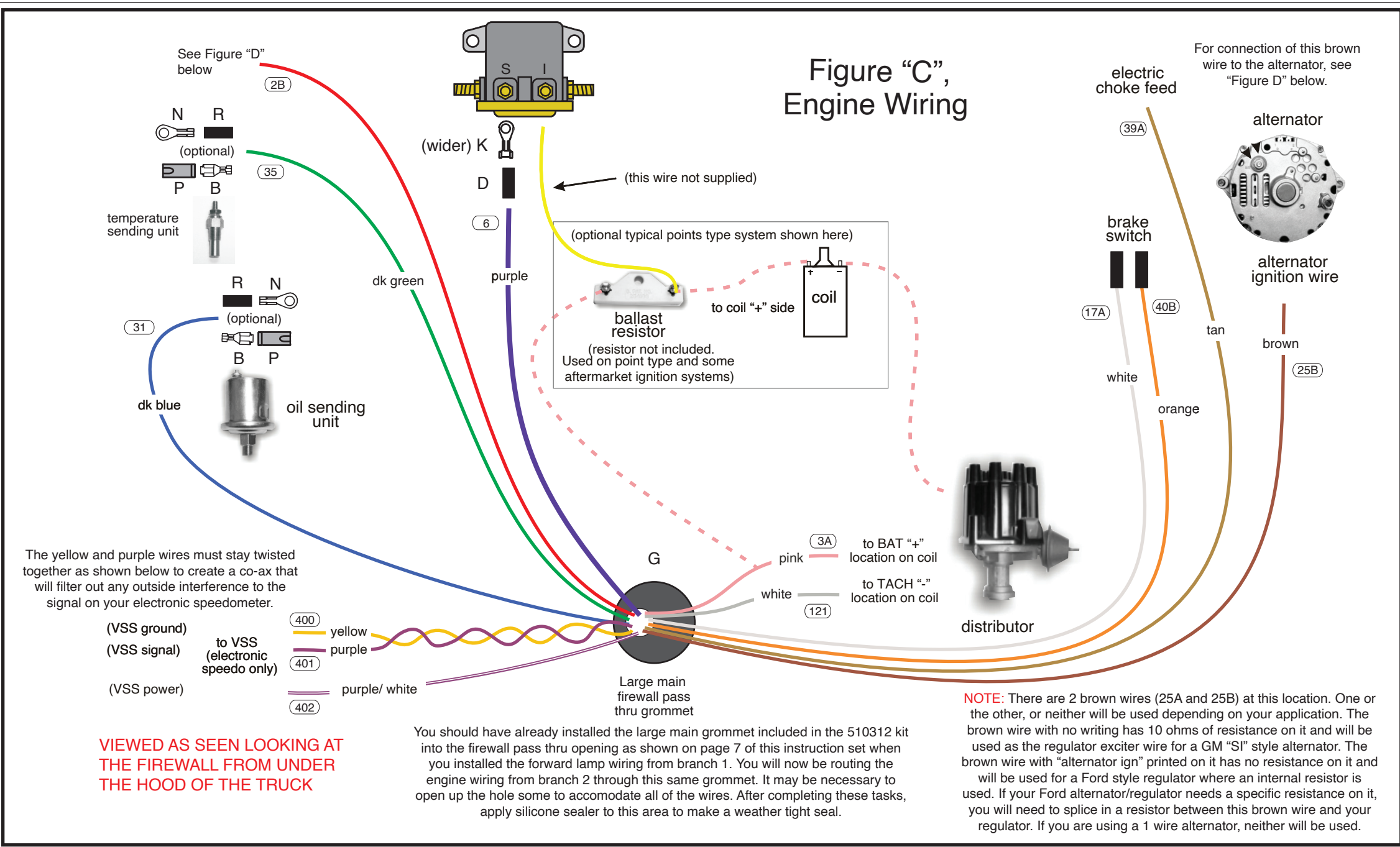

**1953-56 Ford Truck**  
 Classic Update Series  
**510303** 92973564 Rev 0.0 2/1/2022



Fuse Box lid

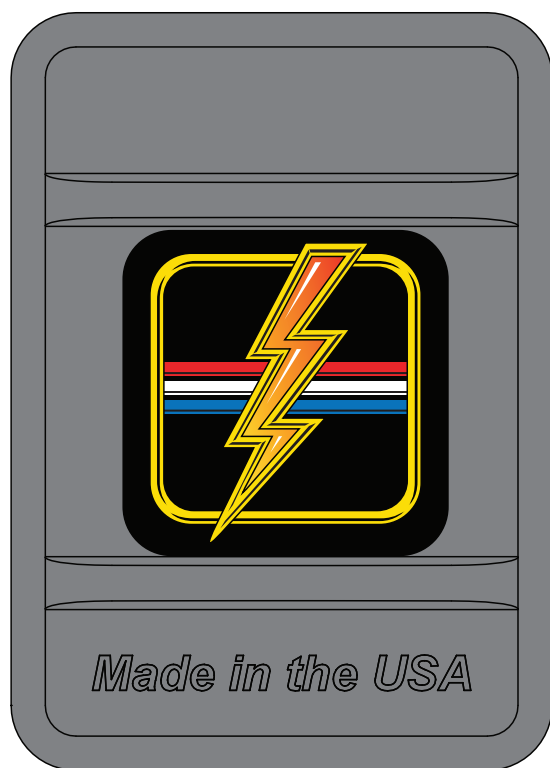

Fuse label on inside of Fuse Box lid

Batt - Spare 30A - BAT	1	9	Wiper 20A - ACC
Clock/Radio 15A - BAT	2	10	Heat/AC 30A - ACC
Power Seat 30A - BAT	3	11	Radio 10A - ACC
Switched Ctsy. 15A - BAT	4	12	Engine Fan 30A - ACC
Power Locks 15A - BAT	5	13	Turn 15A - IGN
Stop/Courtesy 15A - BAT	6	14	Gauges, B/U 10A - IGN
Hazard 15A - BAT	7	15	Elec. Choke 15A - IGN
Pwr. Window 30A - IGN	8	16	Fuel Pump 20A - IGN

Fuse Values and Locations

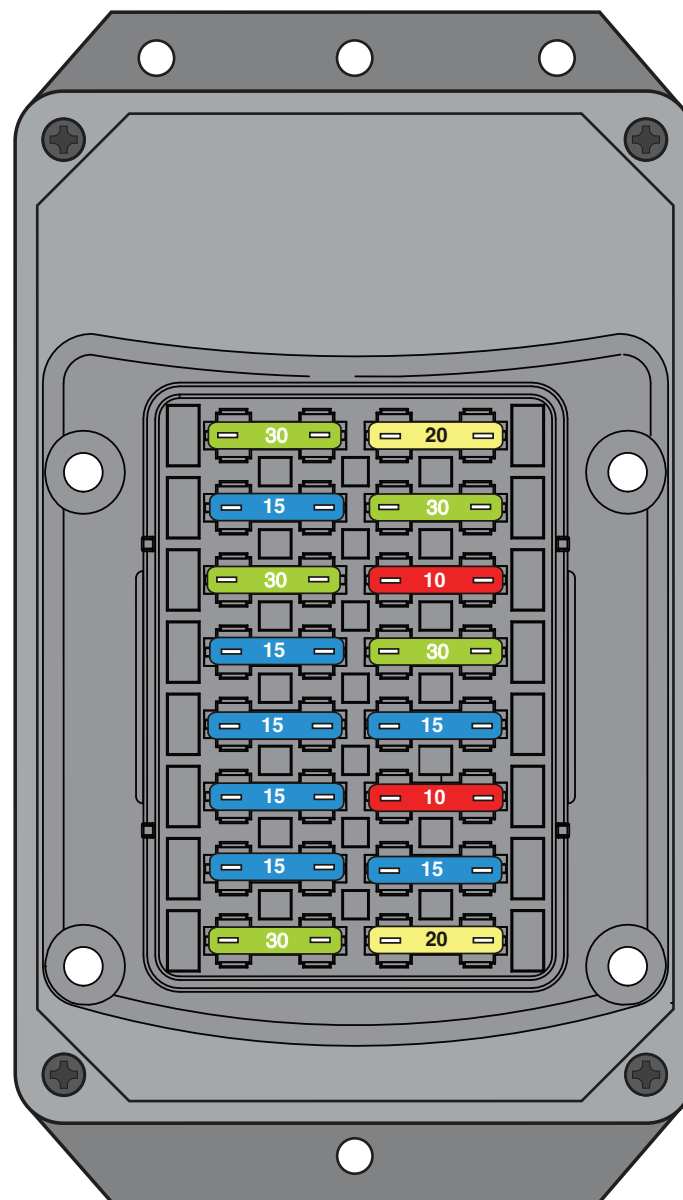

Fuse/Circuit table

Fuse #	Fuse Block Cover Label	Fuse Rating	Description
1	Bat-Spare	30A	Battery feed spare
2	Clock - Bat	15A	Battery feed for a Clock and a Radio.
3	Power Seats	30A	Battery feed for optional Power Seats.
4	Sw. Courtesy	15A	Battery feed to Courtesy Switch
5	Power Locks	15A	Battery feed to Power Locks
6	Stop / Courtesy	15A	Battery feed for Brake Lights and Courtesy Lights.
7	Hazard	15A	Battery feed for optional Hazard Lights and optional battery feed.
8	Power Window	30A	Ignition feed for optional Power Windows.
9	Wiper	20A	12V Accessory feed for Wiper/Washer system.
10	Heat / AC	30A	12V Accessory feed for Heater/AC System.
11	Radio	10A	12V Accessory "on-off" feed to Radio.
12	Engine Fan	30A	12V Accessory for an optional Electric Fan System, Relay key-on trigger
13	Turn	15A	Ignition feed for the Turn Signals.
14	Gauges, B/U	10A	Ignition feed for Dash Gauges/Warning Lights, Back Up Lights
15	Electric Choke	15A	Ignition feed for an Electric Choke, ECM Ignition Feed
16	Fuel Pump	20A	Ignition feed for an Electric Fuel Pump



**American  
Autowire**

www.americanautowire.com 856-933-0801

**1953-56 Ford Truck**  
*Classic Update Series*

**510303** 92973564 Rev 0.0 2/1/2022



**THIS PAGE INTENTIONALLY  
LEFT BLANK**



**American  
Autowire**

[www.americanautowire.com](http://www.americanautowire.com) 856-933-0801

**1953-56 Ford Truck**  
*Classic Update Series*

**510303** 92973564 Rev 0.0 2/1/2022

\*\*\* These are special instructions for connecting your wiring system to a stock instrument cluster. \*\*\*

Note: If you are using aftermarket gauges, follow the instructions included in the 92965220 Gauge Connection Kit along with the specific gauge manufacturers instructions for connection of their gauges.

If you are using the stock gauges and warning lamps, refer to the diagrams on the following pages for your application. Use the enclosed parts and information below for wire termination, gauge, and lamp connections. **PLEASE keep in mind that the 1953-55 stock system and gauges were a 6 volt operation, and as such, you will need a voltage reducer on the gauge feed wires if you choose to utilize your original factory Ford gauges.** Connectors A, B, and C will plug into your dash harness as noted on the Dash Harness instruction (510305, bag G) sheet. Connection C will only be used in the event that you are using an electric speedometer.

#### CONNECTOR A (sheet 2 or 4)

GRAY	Instrument Lamps	Install components as shown on sheets 2 or 4, and plug into the 2 dash illumination holes in the cluster. An inline splice will be necessary in order to make these 2 connections.
BROWN	Alt. Ign.	<b>(Used for 1956 stock clusters only!)</b> Please pay particular attention to the location that this loose brown wire must be plugged into. If you are using a GM alternator/regulator that requires a resistance wire in the circuit, plug this wire into connector A at the end position next to the light green high beam indicator wire. If you are using a Ford alternator/regulator which does NOT use a resistance wire in the circuit (as they usually have an internal resistor in the regulator), plug this wire into connector A between the grey dash lamps and dark blue RH turn indicator wires. Install components as shown on sheet 4, and plug into the generator warning lamp hole in cluster. Plug the pink wire from sheet 5 into the other side of this lamp socket to complete the connection.
DK BLUE	Right Turn Indicator	Install components as shown on sheets 2 or 4, and plug into the right turn indicator hole in the cluster.
LT BLUE	Left Turn Indicator	Install components as shown on sheets 2 or 4, and plug into the left indicator hole in the cluster.
LT GREEN	Hi Beam Indicator Lamp	Install components as shown on sheets 2 or 4, and plug into the high beam indicator hole in the cluster.

#### CONNECTOR B (sheet 3 or 5)

DK BLUE	Oil Gauge / Lamp	Install components as shown on sheets 3 or 5, and attach onto the oil gauge sender stud <b>(1953-55)</b> , or plug the lamp socket into the warning lamp hole in the cluster <b>(1956)</b> . If using a warning lamp, be sure to plug the pink wire from sheet 5 into the other side of this lamp socket to complete the connection.
DK GREEN	Temp Gauge	Install components as shown on sheets 3 or 5, and attach onto the temperature gauge sender stud.
TAN	Fuel Gauge	Install components as shown on sheets 3 or 5, and attach onto the fuel gauge sender stud.
PINK	12v ignition	Install components as shown on sheets 3 or 5, connect to the generator warning light socket <b>(1956)</b> on page 4, oil gauge 12v stud on page 3 <b>(1953-55)</b> , or oil warning light socket on page 5 <b>(1956)</b> , temperature gauge 12v stud (all), and the fuel gauge 12v stud (all). If your truck has a tach, you will also need to connect this to the tach 12v power stud. An inline splice will be necessary in order to make these many different connections.
BLACK	Ground	Install components as shown on sheets 3 or 5, and connect to the back of the instrument cluster housing.
WHITE	Tach (loose wire)	If your car is equipped with a tach, plug this loose wire into Connector B maintaining color continuity with the mating connector on the dash harness, 510303, install components as shown on sheet 3 or 5, and plug onto the tachometer sender blade assembly.

#### CONNECTOR C (sheet 6)

This connector is used when using an aftermarket electronic speedometer only. Follow the manufacturer's instructions when installing these wires. If you are using the stock speedometer, then discard this connector. See page 6 for wire descriptions and a typical connections.



**American  
Autowire**

www.ameriacnautowire.com 856-933-0801

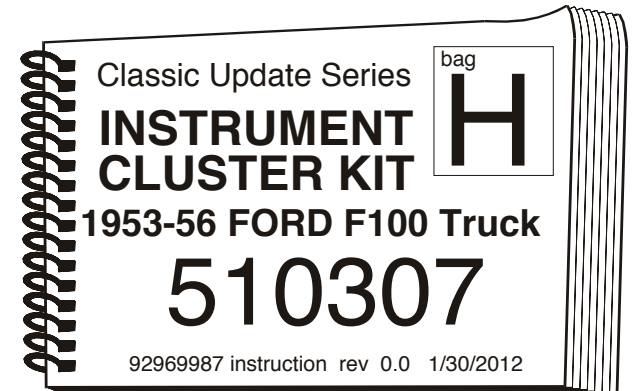

# Classic Update Series

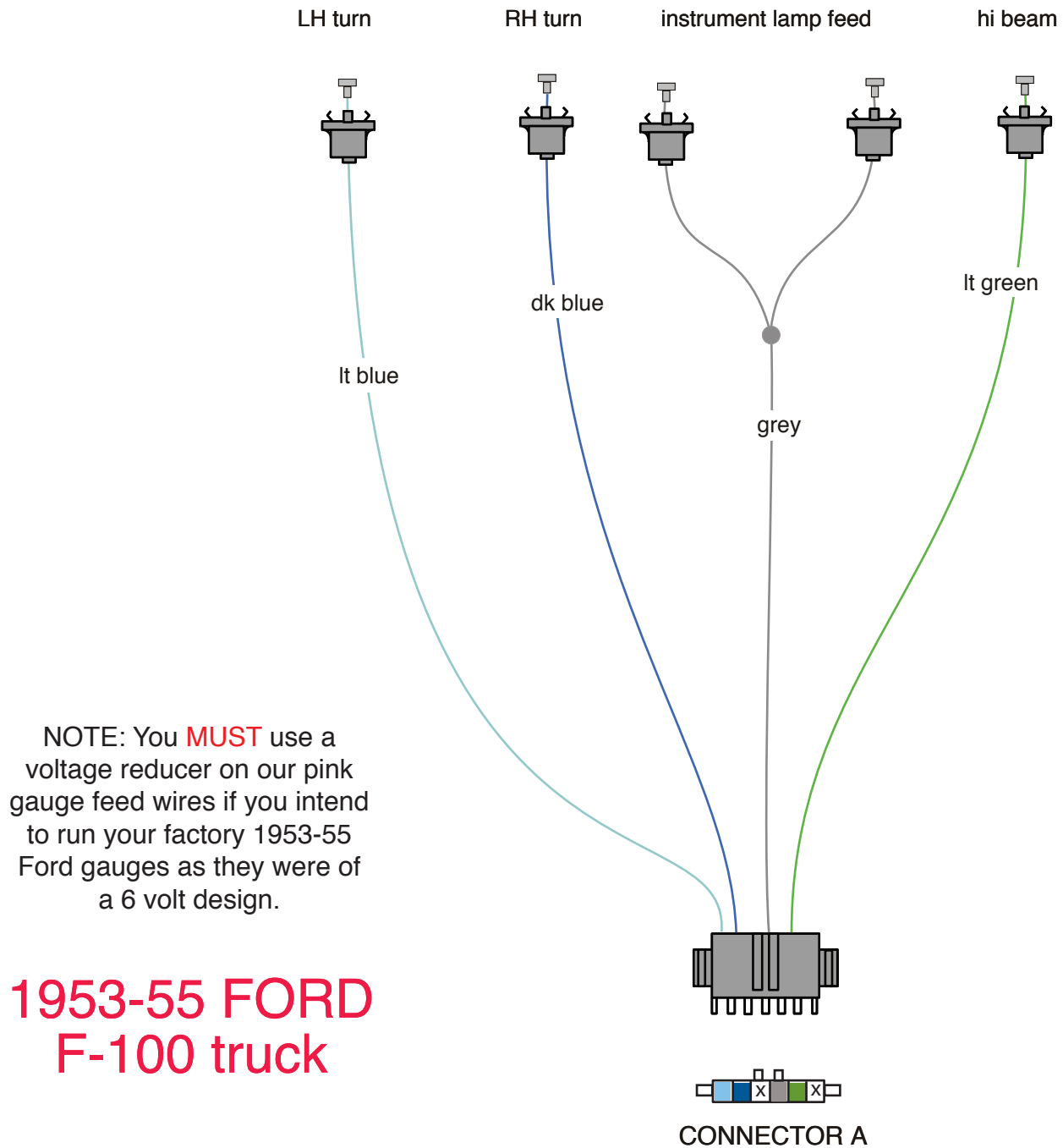

# Classic Update Series

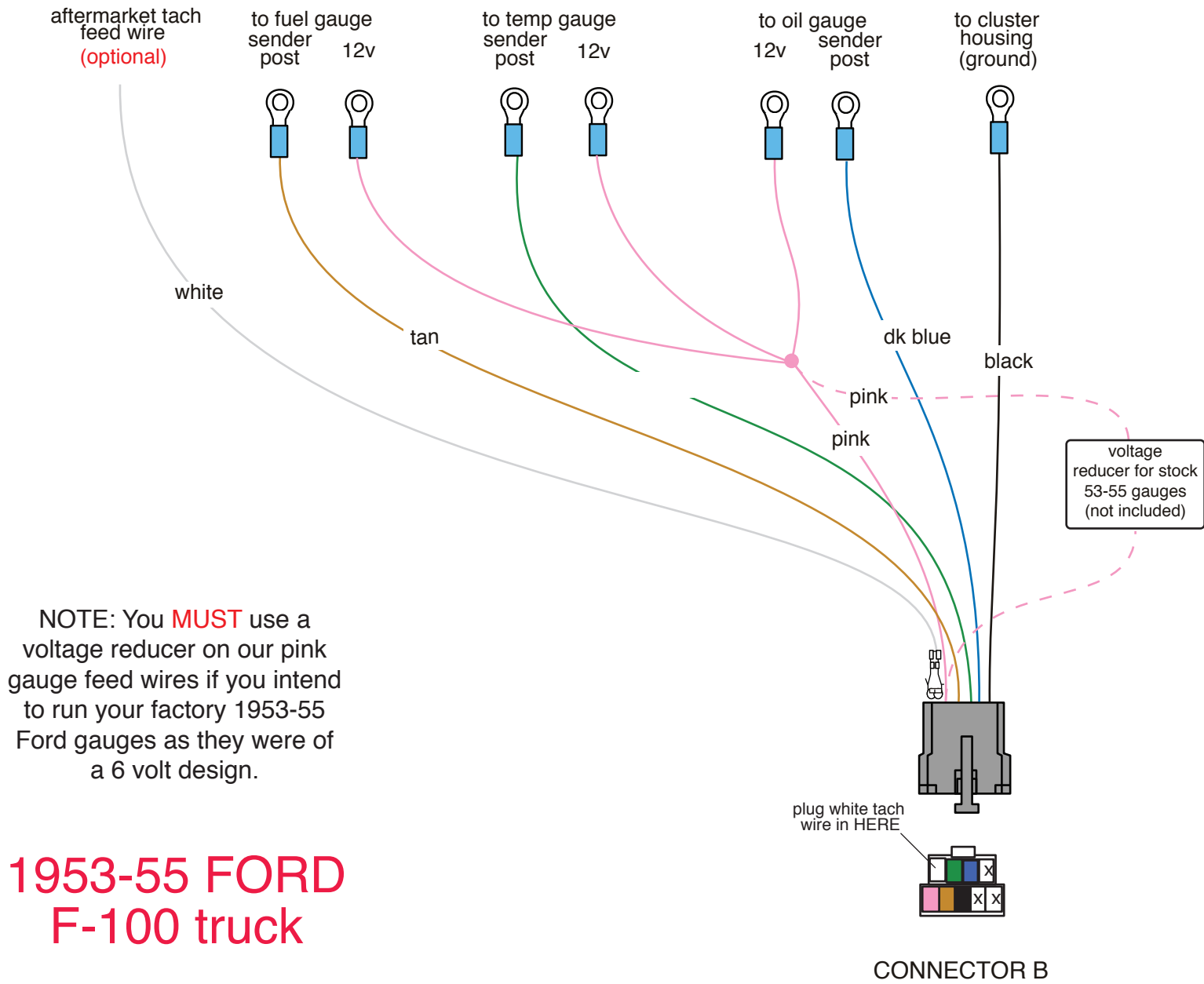

# Classic Update Series

## 1956 FORD F-100 truck

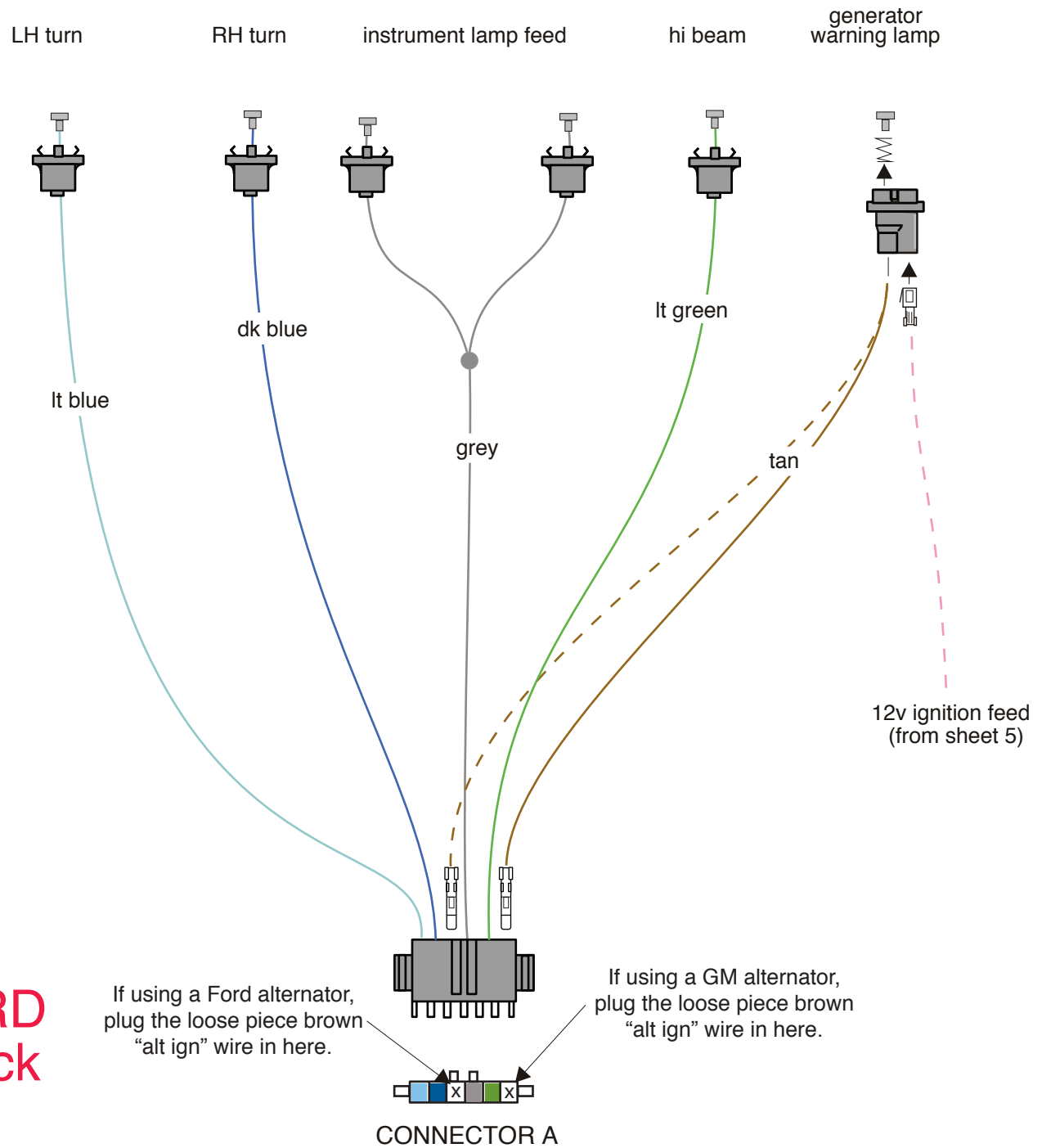

# Classic Update Series

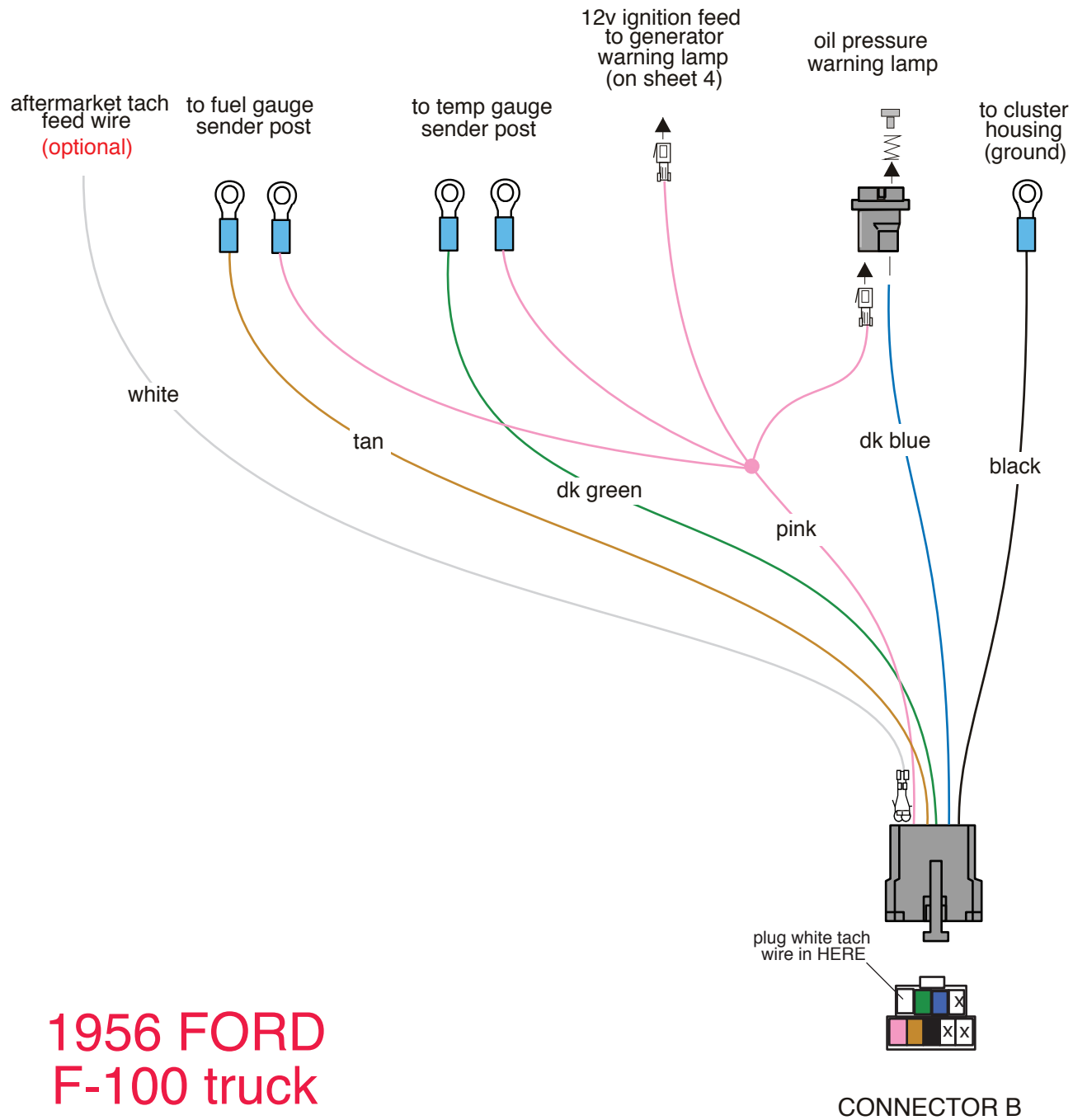

1956 FORD  
F-100 truck

CONNECTOR B



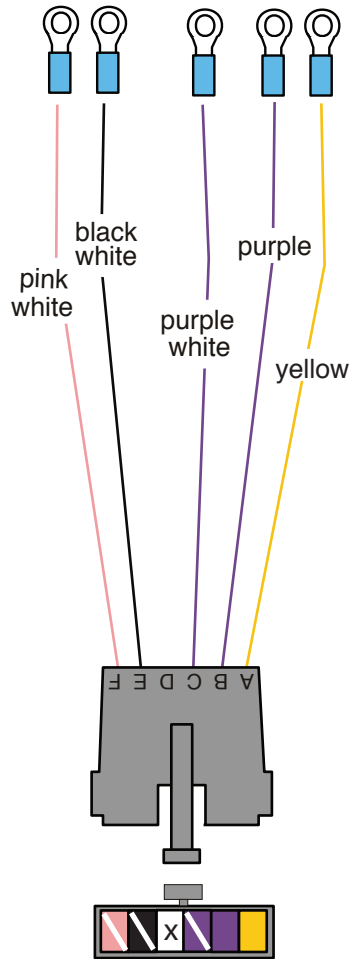

CONNECTOR C

## ALL 1953-56 FORD F-100 truck

### TYPICAL ELECTRIC SPEEDO CONNECTIONS

Below are some general instructions for hooking up an electric speedometer. This connector and these instructions will ONLY be used in the event that you are utilizing an aftermarket electric speedometer. If your car does NOT have an electric speedometer, this connection will NOT be used and should not be plugged onto your dash harness. It is best to consult the speedometer manufacturer's instructions if you have any questions.

<u>Yellow</u>	VSS Ground	Connect to VSS "-" on speedometer.
<u>Purple</u>	VSS Signal	Connect to VSS input on speedometer.
<u>Purple/White</u>	VSS Power	Connect to 12V power on speedometer.
<u>Black/White</u>	Speedo Ground	Connect to ground on speedometer.
<u>Pink/White</u>	Speedo Power	Connect to 12v power on speedometer. <b>NOTE:</b> This wire will double onto the same stud as the purple/white VSS power wire from above.



www.americanautowire.com 856-933-0801

**TYPICAL AFTERMARKET GAUGE CONNECTIONS**  
**(STUD TYPE CONNECTIONS SHOWN)**

**GAUGE CONNECTIONS**

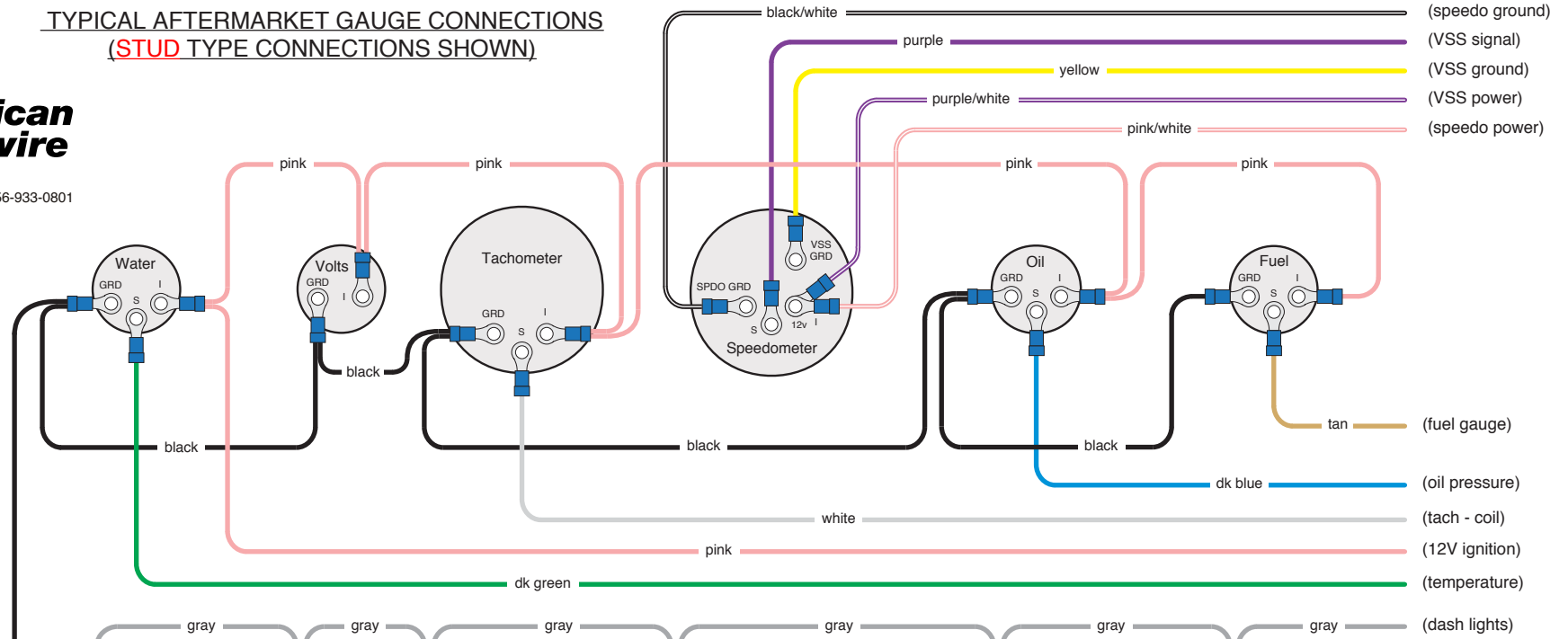

**LAMP CONNECTIONS**

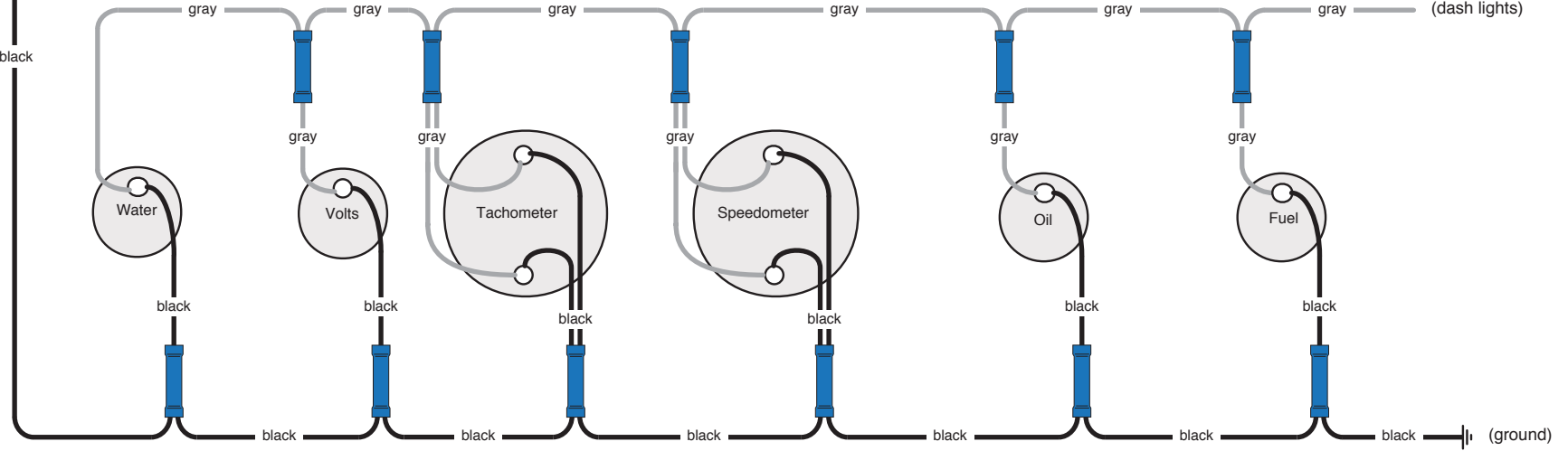

**TURN SIGNAL AND HI-BEAM LAMP CONNECTIONS**

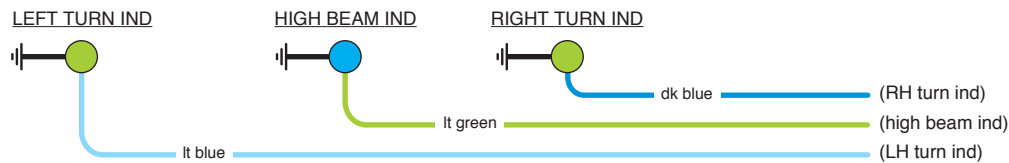

PART # **92965220**  
**Gauge Connection Kit**  
 Complete connections  
 for aftermarket gauges  
 92965221 Rev 1.1 12/12/2014



www.americanautowire.com 856-933-0801

**TYPICAL AFTERMARKET GAUGE CONNECTIONS**  
(BLADE TYPE CONNECTIONS SHOWN)

**GAUGE CONNECTIONS**

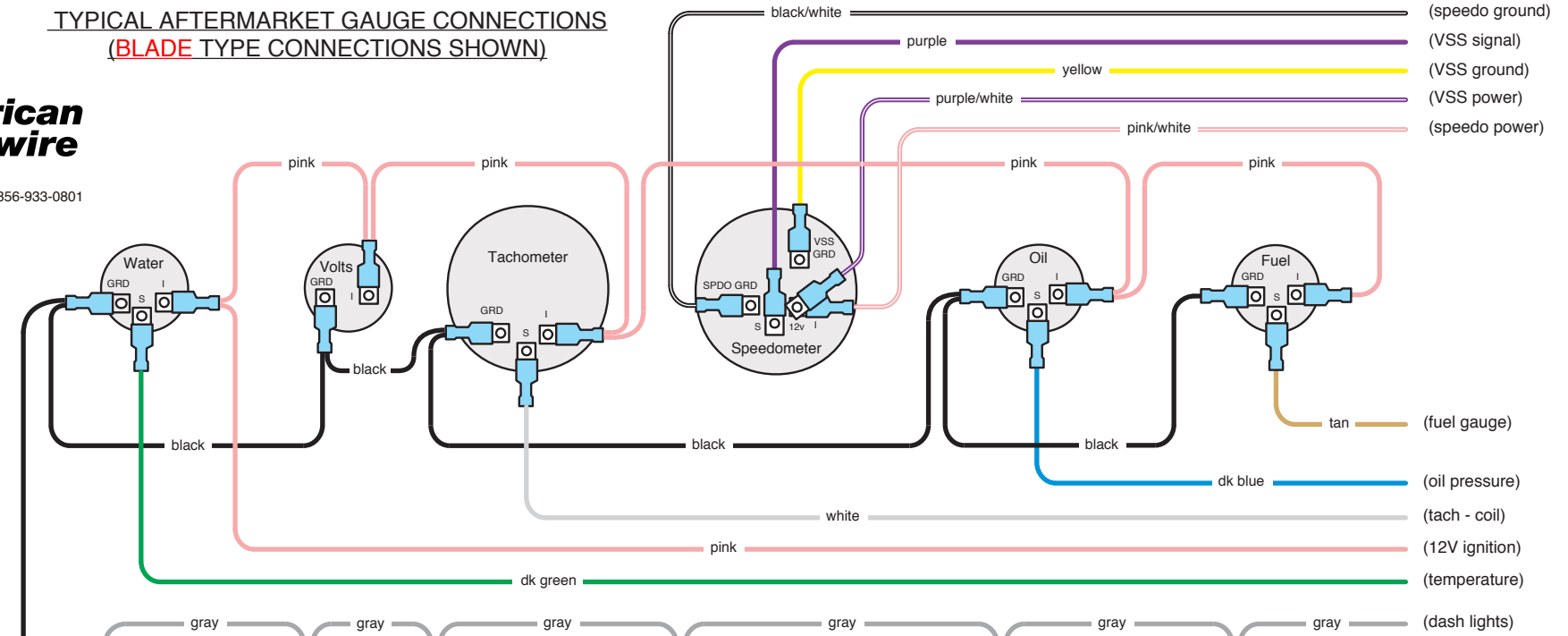

**LAMP CONNECTIONS**

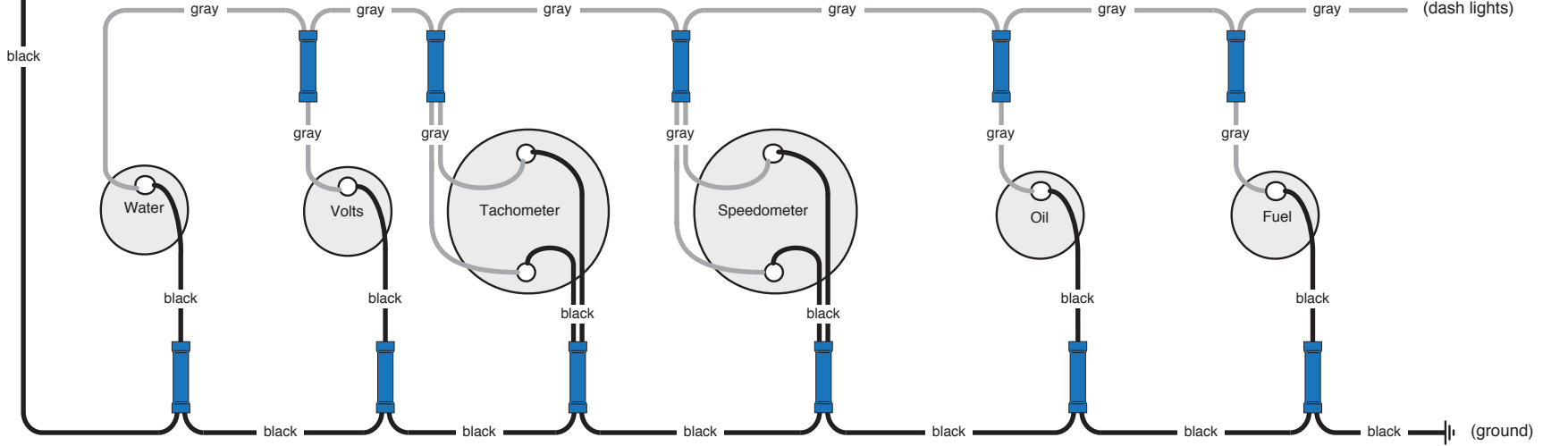

**TURN SIGNAL AND HI-BEAM LAMP CONNECTIONS**

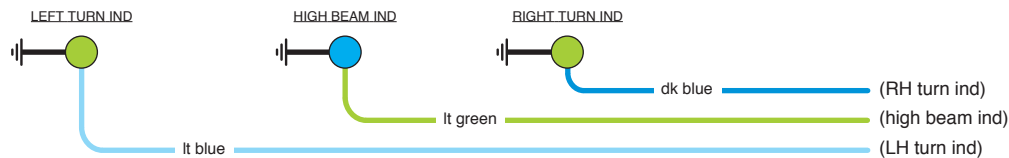

PART # **92965220**  
**Gauge Connection Kit**  
 Complete connections  
 for aftermarket gauges  
 92965221 Rev 1.1 12/12/2014

## Electric Speedo VSS extension connection:

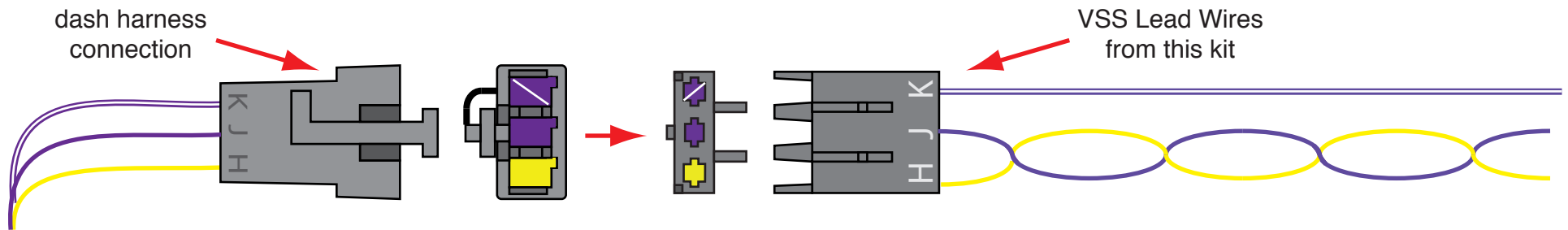

If you are using an aftermarket electric speedometer in your vehicle, you will need to connect the vehicle speed sensor (VSS) Lead Wires from this kit to the dash side connection of your dash harness. The yellow and solid purple wires must remain twisted together as shown above. These three wires will need to pass through the firewall or floor of your vehicle down to the vehicle speed sensor unit in the transmission. Generally, the solid purple wire connects to the “signal” lead, the yellow wire connects to the “ground” lead, and the purple/white stripe wire connects to the “12 volt power” lead on the vehicle speed sensor assembly. However, you should consult the directions that came with your gauges, and connect your vehicle speed sensor per the manufacturer’s instructions.



[www.americanautowire.com](http://www.americanautowire.com) 856-933-0801

VSS LEAD WIRES  
Various Applications  
Classic Update Series

**510730**

92972371 Rev 0.0 4/9/2019

bag  
**V**

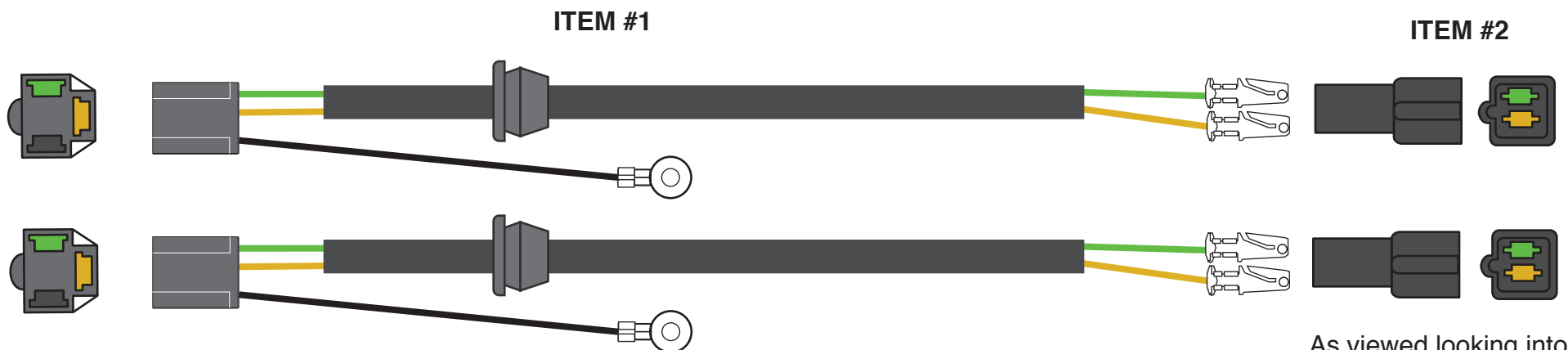

As viewed looking into the open end of the connector assembly

1. There are 2 headlight bucket harnesses (item #1) included in this kit (510306). Each one has been plugged into the headlight socket connector and has the grommet and loom installed on it.
2. Also included in this kit are 2 loose piece connectors (item #2).
3. Install one bucket harness into each bucket housing and snap the grommet and loom assembly into the hole in that bucket housing.
4. Attach each ground wire (with the ring terminal on it) to the mounting hole on that bucket housing. This will ground your headlamps once the bucket assemblies have been installed into the grill shell assembly. Make sure that you have no 2-stage paint or powder coating at any of the attaching locations or the grounds will not transfer, and your headlights will not work.
5. Be sure that you have lined the 4 holes in the grill shell with the grommets from the 510308 Grommet and Parts kit. You can now install the assembled buckets into the grill shell assembly by passing the tan and light green wires with the bare terminals through the upper grommeted holes in the grill shell.
6. Once the tan and light green wires have been installed through the upper holes in the grill shell, you can then install each of the bare terminal ends on the tan and light green wires into the provided loose connectors (item #2) maintaining the color continuity as shown on this page above.
7. You will plug these completed bucket harness assemblies into the front light portion of the new dash/main harness (510305) as shown in the instructions on page 9 of the dash/main harness to complete your headlight circuits.



**American  
Autowire**

www.americanautowire.com 856-933-0801



# Classic Update Series

 orange

("12 volt battery fused" only used with LED tail lamps)  
Plug into the main connector and maintain continuity with dash harness.

 lt blue

("Third brake light" - only used when needed)  
Plug into the main connector and maintain color and function continuity with dash harness. See below for suggested connection.

 lt green

("Back-up lamp feed" - only used when needed)  
Plug into the main connector and maintain continuity with dash harness. See below for suggested connection.

 lt blue

("12V CTSY SW" - dome lamp feed. Only used when needed)  
Plug into the main connector and maintain color and function continuity with dash harness. See below for suggested connection.

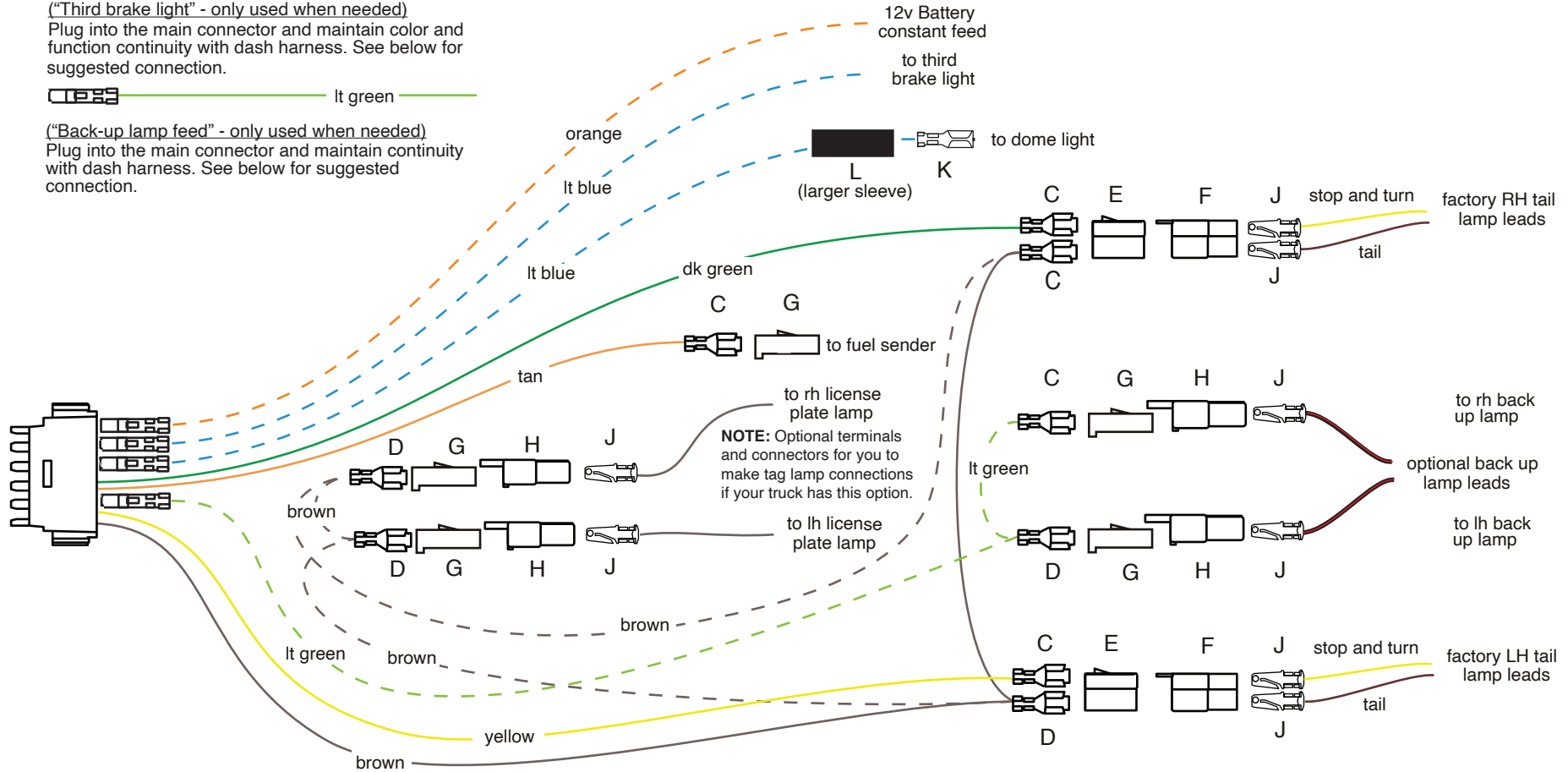

1953-1956 Ford Truck



**American Autowire**

www.americanautowire.com 856-933-0801

Classic Update Series  
1961-66 Ford Truck  
1953-56 Ford Truck

bag  
**M**

REAR BODY KIT

**510263**

92969835 instruction rev 1.0 1/13/2012



## 1953-1956 Ford Truck

Connect this main connector to the mating connector on the dash harness 510305, bag G. Route the tail lamp and back up lamp wires out through the engine wire branch hole in the firewall, down the firewall to the floor area, and to the back of the truck along the driver side frame rail.



LIGHT BLUE Third Brake Light

Plug this loose wire into the main connector maintaining color and function continuity with the dash harness (510305), then connect the other end to the third brake lamp if so equipped.



TAN Fuel Tank Sender

Route this wire either up thru the "A" pillar then back down the "B" pillar to the fuel tank sending unit, or down across the floor and up to the fuel tank sending unit. Cut to length, install terminal C and plug into connector G as shown on sheet 1. Install the completed wire assembly onto the sender unit blade to complete the fuel tank sender connection.



Note: Many stock Ford trucks did not utilize a tag lamp. However, this kit does provide you with terminals D and J along with connectors G and H so that you can connect your tag lamp(s) if your truck does have this option. Please note the optional brown wire routing and assembly instructions shown below as a dotted line if you are using that option.

BROWN Running Lamps

If your truck has a tag lamp, see the note above. Route this wire to the LH tail lamp, cut to length, double this wire with the cut off portion, install terminal D and plug into connector E in the location shown on sheet 1. (Instructions with tag lamps: Route the loose end of this brown wire to the LH license lamp area, cut to length, double this wire with the cut off portion, install terminal D and plug into connector G as shown on sheet 1. Route the loose end of this brown wire to the RH license lamp area, cut to length, double this wire with the cut off portion, install terminal D and plug into connector G as shown on sheet 1.) Route the loose end of this brown wire to the RH tail lamp area, cut to length, install terminal C and plug into connector E in the location shown on sheet 1.



YELLOW LH Stop / Tail

Route this wire to the LH tail lamp area, cut to length, install terminal C and plug into the empty cavity of connector E as shown on sheet 1. Terminals J and connector F have been provided for you to crimp onto your stop and tail lamp leads to complete the connection to the LH stop, turn, and tail assembly.

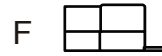

DK GREEN RH Stop / Tail

Route this wire to the RH tail lamp area, cut to length, install terminal C and plug into the empty cavity of connector E as shown on sheet 1. Terminals J and connector F have been provided for you to crimp onto your stop and tail lamp leads to complete the connection to the RH stop, turn, and tail assembly.



LIGHT GREEN Back Up Lamp Feed

If your truck has the back up lamp option, plug this loose wire into the main connector maintaining color and function continuity with the dash harness (510305), then route this wire to the LH back up lamp area, cut to length, double this wire with the cut off portion, install terminal D and plug into connector G as shown on sheet 1. Route the loose end of this light green wire over to the RH back up lamp area, cut to length, install terminal C and plug into connector G as shown on sheet 1. Terminals J and connectors H have been provided for you crimp onto your back up lamp leads to complete the connection to the LH and RH assemblies.



LIGHT BLUE 12V Courtesy Switched

If your truck has a dome lamp assembly, plug this loose wire into the main connector maintaining color and function continuity with the dash harness (510305), then route this wire either up thru the "A" pillar then thru the roof area to the dome lamp unit, or down across the floor and then up thru the back of the cab to the roof area to the dome lamp unit. Cut to length, slide the larger rubber sleeve L onto the wire, then crimp terminal K onto the wire. Slide the rubber sleeve up over the terminal to protect and seal the terminal from shorting out against any sheet metal. Install the completed wire assembly onto the dome lamp unit. The dome lamp assembly typically has a ground wire attached to it, or is self grounding.



ORANGE 12 Volt Battery Fused

If your truck has LED tail lamps that require a full time 12 volt battery feed for memory purposes, plug this loose wire into the main connector maintaining color and function continuity with the dash harness (510305), route this wire to the LH stop, turn, and tail assembly then continue it on over to the RH stop, turn, and tail assembly.

# Classic Update Series

 orange

("12 volt battery fused" only used with LED tail lamps)  
Plug into the main connector and maintain continuity with dash harness.

 lt blue

("Third brake light" - only used when needed)  
Plug into the main connector and maintain color and function continuity with dash harness. See below for suggested connection.

 lt green

("Back-up lamp feed" - only used when needed)  
Plug into the main connector and maintain continuity with dash harness. See below for suggested connection.

 lt blue

("12V CTSY SW" - dome lamp feed. Only used when needed)  
Plug into the main connector and maintain color and function continuity with dash harness. See below for suggested connection.

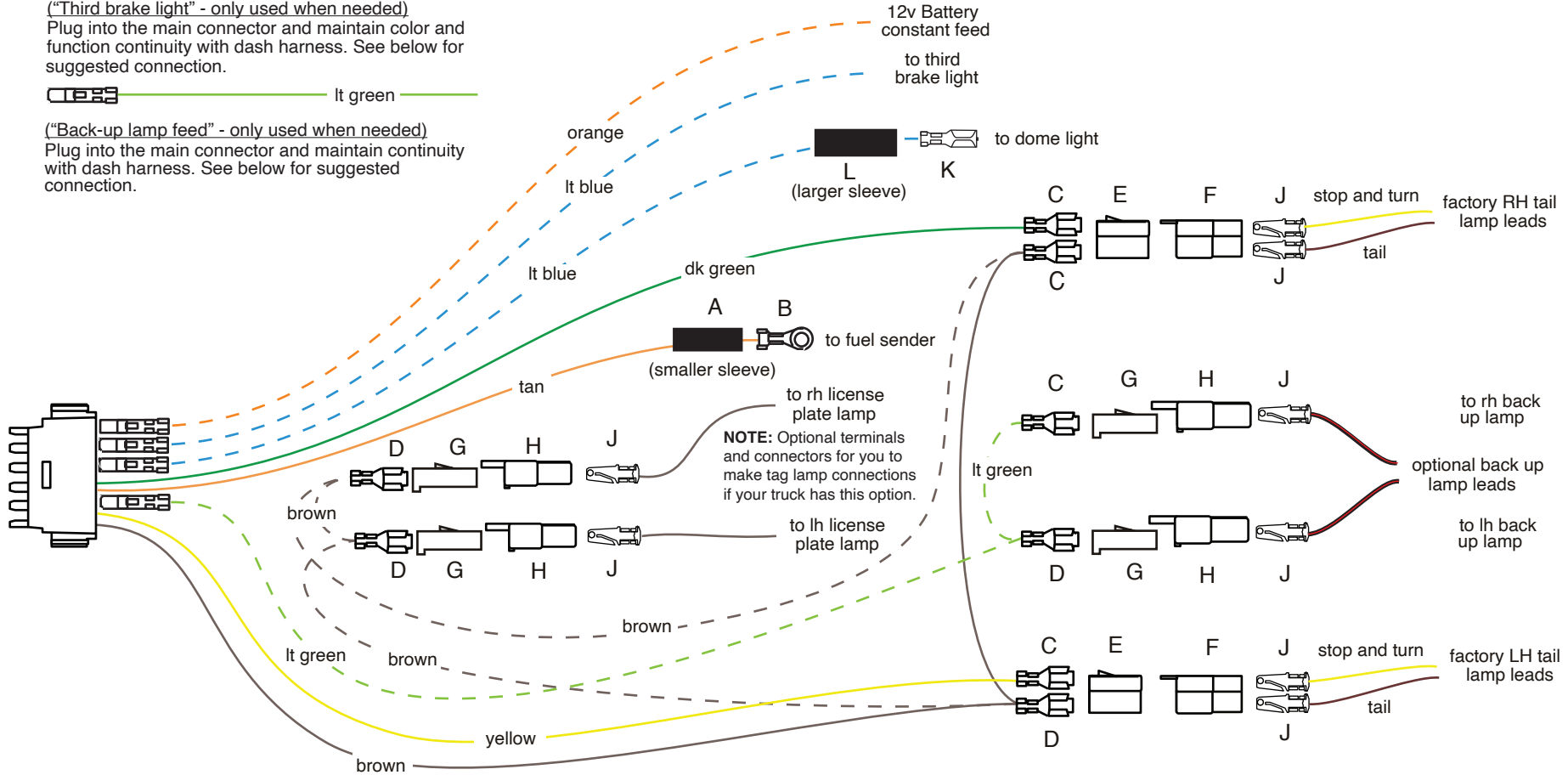

1961-1966 Ford Truck



**American Autowire**

www.americanautowire.com 856-933-0801

Classic Update Series bag

1961-66 Ford Truck M

1953-56 Ford Truck











**REAR BODY KIT**

**510263**

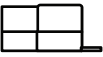
92969835 instruction rev 1.0 1/13/2012

## 1961-1966 Ford Truck

Connect this main connector to the mating connector on the dash harness 510262, bag G. Route the tail lamp and back up lamp wires out through the engine wire branch hole in the firewall, down the firewall to the floor area, and to the back of the truck along the driver side frame rail.

A		LIGHT BLUE	Third Brake Light	Plug this loose wire into the main connector maintaining color and function continuity with the dash harness (510262), then connect the other end to the third brake lamp if so equipped.
B		TAN	Fuel Tank Sender	Route this wire either up thru the "A" pillar then back down the "B" pillar to the fuel tank sending unit, or down across the floor and up to the fuel tank sending unit. Cut to length, slide the smaller rubber sleeve A onto the wire then crimp terminal B onto the wire. Slide the rubber sleeve up over the terminal crimp area and install the completed wire assembly onto the sender unit threaded stud to complete the fuel tank sender connection.
C				<u>Note:</u> Many stock Ford trucks did not utilize a tag lamp. However, this kit does provide you with terminals D and J along with connectors G and H so that you can connect your tag lamp(s) if your truck does have this option. Please note the optional brown wire routing and assembly instructions shown below as a dotted line if you are using that option.
D		BROWN	Running Lamps	If your truck has a tag lamp, see the note above. Route this wire to the LH tail lamp, cut to length, double this wire with the cut off portion, install terminal D and plug into connector E in the location shown on sheet 3. ( <u>Instructions with tag lamps:</u> Route the loose end of this brown wire to the LH license lamp area, cut to length, double this wire with the cut off portion, install terminal D and plug into connector G as shown on sheet 3. Route the loose end of this brown wire to the RH license lamp area, cut to length, double this wire with the cut off portion, install terminal D and plug into connector G as shown on sheet 3.) Route the loose end of this brown wire to the RH tail lamp area, cut to length, install terminal C and plug into connector E in the location shown on sheet 3.
E				
F		YELLOW	LH Stop / Tail	Route this wire to the LH tail lamp area, cut to length, install terminal C and plug into the empty cavity of connector E as shown on sheet 3. Terminals J and connector F have been provided for you to crimp onto your stop and tail lamp leads to complete the connection to the LH stop, turn, and tail assembly.
G		DK GREEN	RH Stop / Tail	Route this wire to the RH tail lamp area, cut to length, install terminal C and plug into the empty cavity of connector E as shown on sheet 3. Terminals J and connector F have been provided for you to crimp onto your stop and tail lamp leads to complete the connection to the RH stop, turn, and tail assembly.
H				
J		LIGHT GREEN	Back Up Lamp Feed	If your truck has the back up lamp option, plug this loose wire into the main connector maintaining color and function continuity with the dash harness (510262), then route this wire to the LH back up lamp area, cut to length, double this wire with the cut off portion, install terminal D and plug into connector G as shown on sheet 3. Route the loose end of this light green wire over to the RH back up lamp area, cut to length, install terminal C and plug into connector G as shown on sheet 3. Terminals J and connectors H have been provided for you crimp onto your back up lamp leads to complete the connection to the LH and RH assemblies.
K				
L		ORANGE	12 Volt Battery Fused	If your truck has LED tail lamps that require a full time 12 volt battery feed for memory purposes, plug this loose wire into the main connector maintaining color and function continuity with the dash harness (510262), route this wire to the LH stop, turn, and tail assembly then continue it on over to the RH stop, turn, and tail assembly.

## In this kit you will find the following:

1. 4 cushioned clamps.
2. 4 small rubber grommets.
3. Misc. connectors and terminals to complete engine, alternator, and forward lamp connections.
4. Main firewall grommet.
5. New Door Jamb Switches

The cushioned clamps may be used to securely route the engine harness wires up across the back of the firewall in the engine bay behind the engine if so desired. We have not provided any bolts to secure the clamps to the firewall as there are several different styles available and we have left that to the builder's taste. The 4 small grommets will be used to line the stock grill shell and headlight ring / parking lamp areas prior to routing the new harness through those areas. A photo of the grill shell grommets on our test vehicle are shown at the right for your reference. The various terminals and connectors will be used to complete the many connections under the hood of the truck. These detailed installation instructions can be found on pages 9 and 10 of the main instruction set (92969976). The main firewall grommet is used to line the stock firewall opening where the main harness exits the cab and goes out into the engine bay. We have NOT provided a firewall grommet retainer as there are several designs available from raw stamped, to plated, to billet, and we have left that to the builder's taste. The new door jamb switches will install into your stock door jamb openings and will allow your dome and new underdash courtesy lamps to function with the opening of your doors.

Grill Shell Grommets

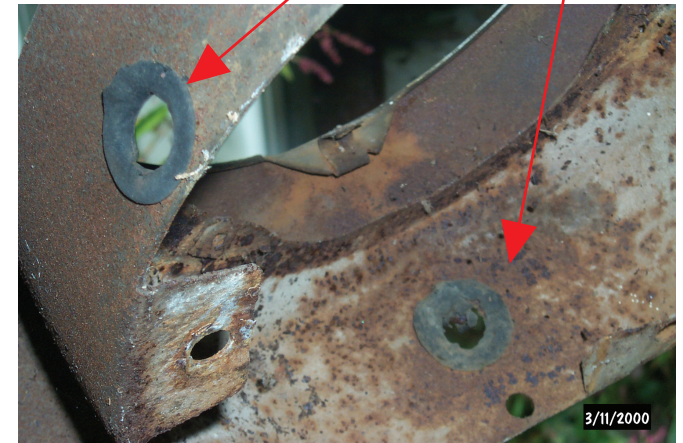

**American  
Autowire**

www.americanautowire.com 856-933-0801

PART #

**510312**

DESCRIPTION:









Clamp, Grommet, and Parts Kit  
1953 - 56 Ford Truck  
Classic Update Series

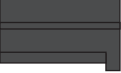
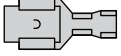

92969991

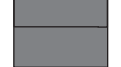
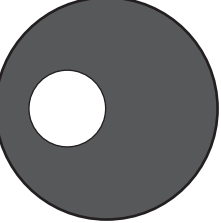
Rev 2.0

9/24/2018

In the box below, you will find the legend for the misc. terminals, plastic connector bodies, and the main firewall grommet that will be used to complete your main power, forward lighting, engine, and alternator connections. They are itemized and referred to on this page just as they are on pages 9 and 10 of the Main instruction set (92969976). The grill shell grommets, firewall clamps, and new door jamb switches (for the courtesy lamps) are also located in this package but are not shown on pages 9 and 10.

- A  (56 series double female connector, 2 pcs.)
- B  (56 series single female terminal, 15 pcs.)
- C  (56 series double female terminal, 4 pcs.)
- D  (large rubber sleeve, 4 pcs.)
- E  (56 series single female conn. with lock wedge, 1 pc.)
- F  ("T" shaped 56 series double female connector, 2 pcs.)
- G  (large main firewall grommet, 1 pc.)
- H  ("T" shaped 56 series double male connector, 2 pcs.)
- J  (56 series single male terminal, 4 pcs.)
- K  (small ring terminal for larger gauge wire, 6 pcs.)
- M  (56 series double male terminal, 2 pcs.)

- N  (small ring terminal for smaller gauge wire, 6 pcs.)
- P  (56 series single female conn. with notch, 2 pcs.)
- R  (small rubber sleeve, 2 pcs.)

**Also included but not shown on pages 9 or 10:**

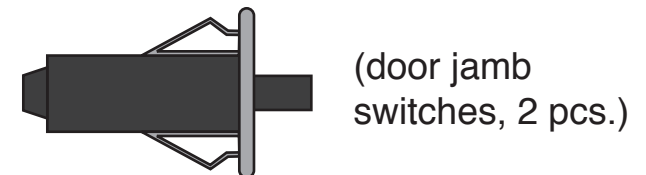
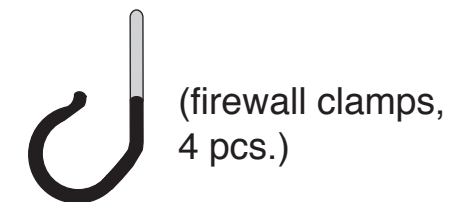
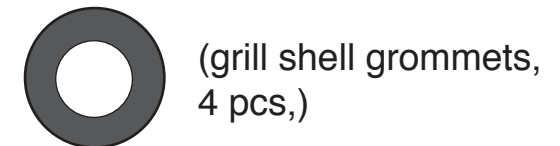

A  (1)  
 (144.0" 6 Gauge charge wire)

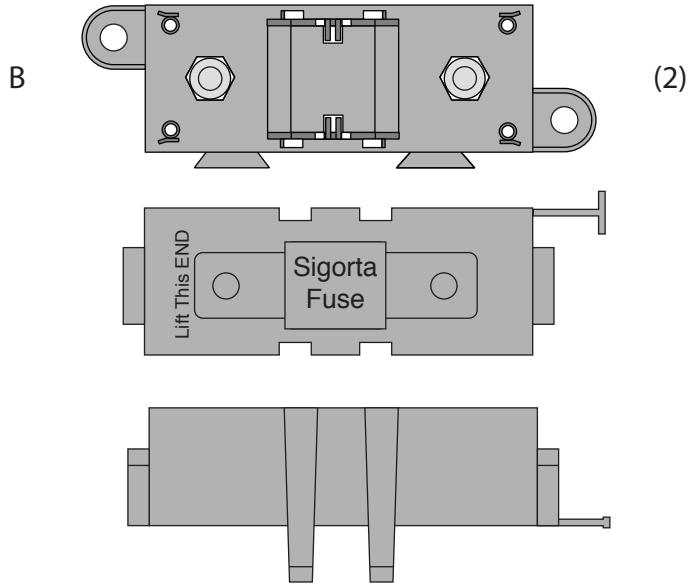

1. On this page, you will find the wire, fuse bodies, fuses, boot, ring terminals, and shrink tubing (items A through K) that are necessary to connect your alternator and main power feed for your new AAW wiring kit. Please be sure that all of the necessary components are present before starting this portion of your installation. If anything is missing, stop what you are doing and contact AAW at the number listed below right away.

2. On page 2, you will find directions for building the 2 Megafuse assemblies (items B,C and D) into one unit.

3. On page 3, you will find an overall concept of how to connect the Megafuse assemblies to your starter solenoid, alternator and main power feed of your new wiring system.

4. On page 4, you will find tips on building your charging circuit wires and assembling them and the main panel power feed wire to the Megafuse assemblies.

(Megafuse body, cover and two M8 x 1.25 nuts / lock washers)

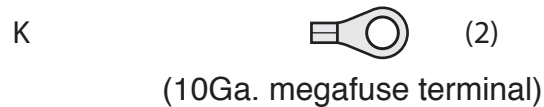
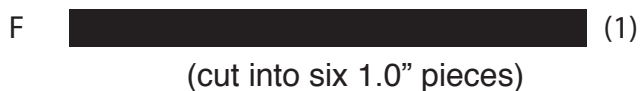
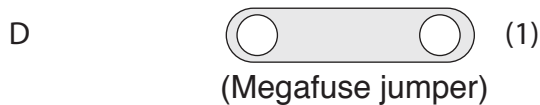
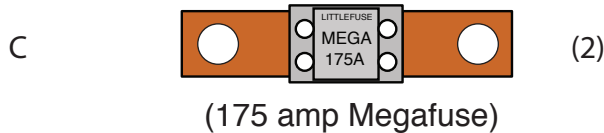

www.americanautowire.com 856-933-0801

PART #

510476

Z

DESCRIPTION:

Alternator and Main Power  
 Connection Kit  
 Various Applications

92972153 instruction sheet rev 0.1 6/24/2019



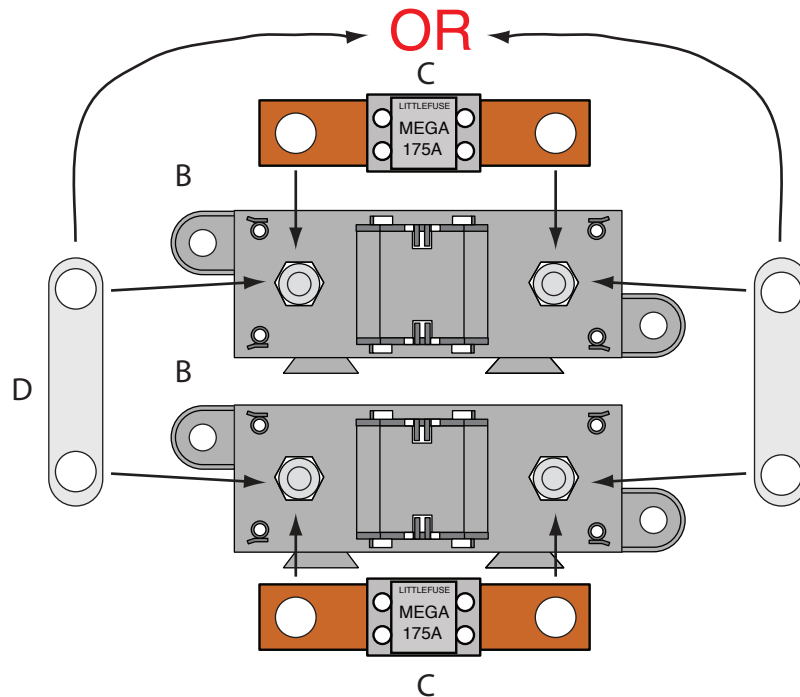

## Assembling the (2) Megafuse assemblies

**NOTE:** Find a suitable place, as close to the battery power source as possible, under the hood of your vehicle to mount the completed Megafuse assemblies. Keep in mind that you have 12 feet of 6Ga. charging wire, and that the main power feed coming from your panel or bulkhead connection must also be able to reach the assembly.

1. Take the two Megafuse bodies and covers (items B) and snap them together. Remove the 4 nuts and lock washers from the studs on the fuse body assemblies.
2. Install the Megafuse jumper (item D above) over two of the studs on the Megafuse bodies. It is very important that the jumper **MUST BE** assembled on the side that is going to connect to your main power connection (starter solenoid or battery feed).
3. Notch top cover to clear jumper D as shown at right.
4. Snap one 175amp fuse (items C) onto the studs of each of the two Megafuse bodies (items B), over the jumper, then loosely re-attach the 4 nuts and lock washers back onto the assembled Megafuses. The fuse assemblies are ready to install into your vehicle.

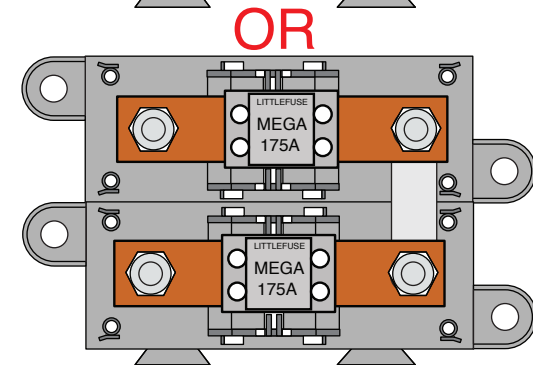
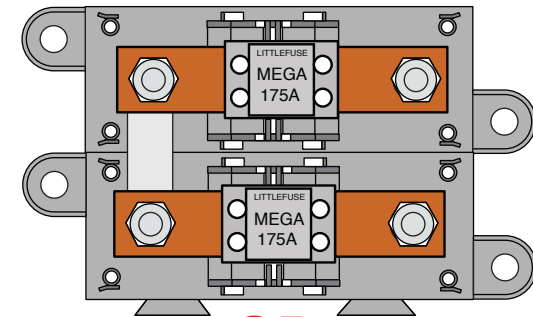

## Assembled Megafuses

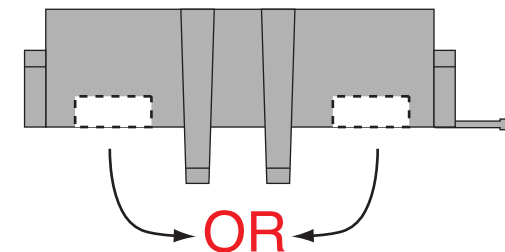

## Notched Cover

PART #

**510476**

**Z**

DESCRIPTION:

Alternator and Main Power  
Connection Kit  
Various Applications

92972153 instruction sheet rev 0.1 6/24/2019

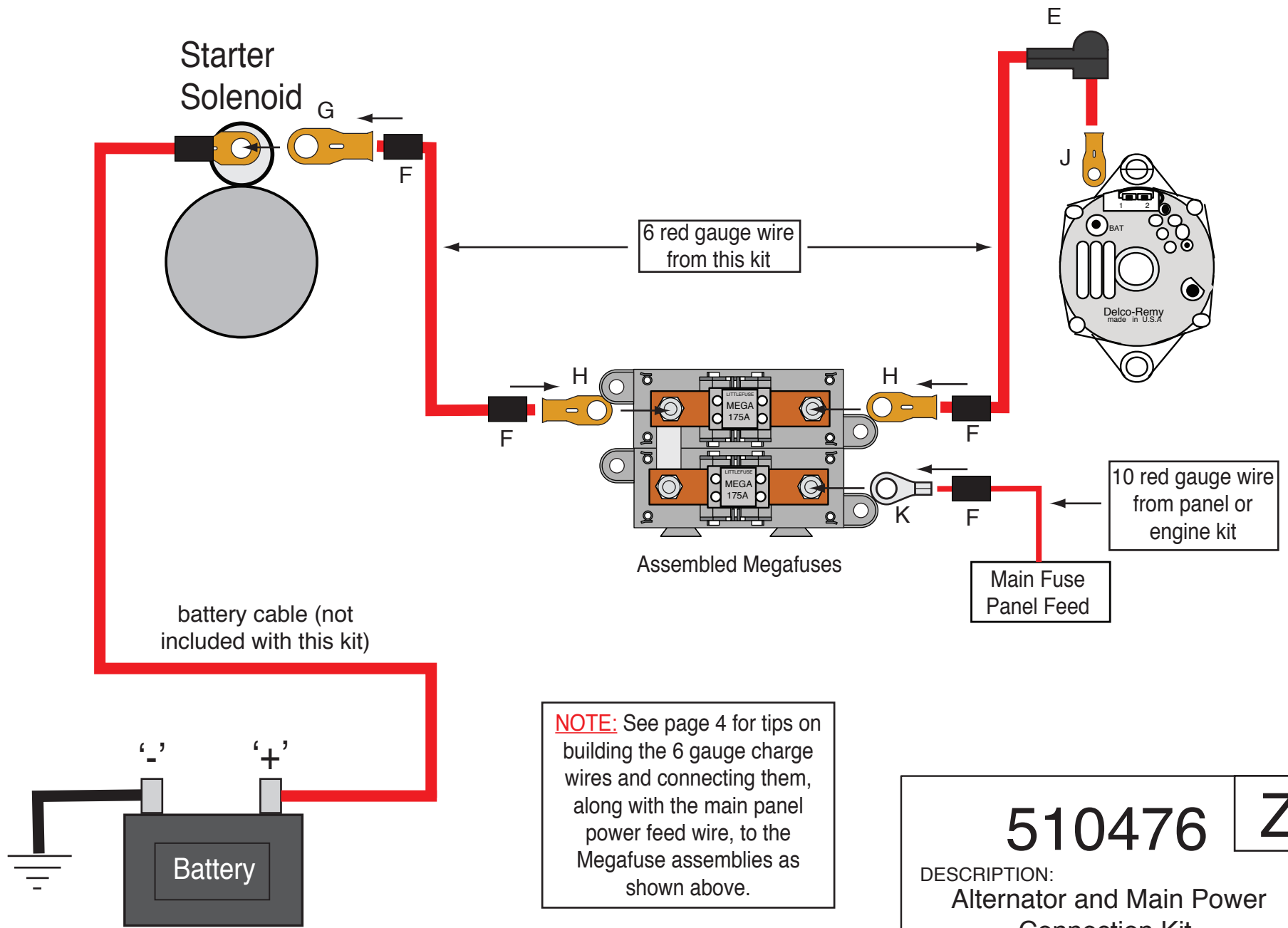

**NOTE:** See page 4 for tips on building the 6 gauge charge wires and connecting them, along with the main panel power feed wire, to the Megafuse assemblies as shown above.

<h1>510476</h1>	<b>Z</b>
<p>DESCRIPTION:  <b>Alternator and Main Power Connection Kit</b>  <b>Various Applications</b></p>	
<p>92972153 instruction sheet rev 0.1 6/24/2019</p>	



## **Building the 6Ga. charge wires and connecting them and the main panel power feed wire to the Megafuse assemblies:**

**NOTE:** Make sure that your battery is disconnected! You will need to install the preassembled Megafuses from page 2 in your vehicle to start this part of the installation.

1. Pre-cut item F shrink tubing into (6) 1.00" - 1.25" pieces.
2. Take the 12-foot piece of 6Ga. red wire from this kit and route it from your starter (or other battery feed) over to the area where you have mounted your Megafuse and cut it to length. Strip the insulation on each end back 1/2". Install 2 pieces of shrink tubing F onto the wire. At the starter end, crimp and solder (1) of terminal G onto the wire. At the Megafuse end, crimp and solder (1) of terminal H onto the wire. Slide the shrink tubing over the terminals and heat it up to shrink it down.
3. Take the remaining portion of the 12-foot piece of 6Ga. red wire from this kit and route it from your alternator over to the area where you have mounted your Megafuse and cut it to length. Strip the insulation on each end back 1/2". Install 1 piece of shrink tubing F onto the wire. At the alternator end, slip on boot E as shown on page 3, then crimp and solder (1) of terminal J onto the wire. At the Megafuse end, crimp and solder (1) of terminal H onto the wire. Slide the shrink tubing over terminal H and heat it up to shrink it down.
4. Take the 10Ga. red main power feed wire from your engine or panel sub-kit and route it over to the area where you have mounted your Megafuse and cut it to length. Strip the insulation back 3/8". Install 1 piece of shrink tubing F onto the wire, then crimp and solder (1) of terminal K onto the wire.
5. Remove the 4 loosely tightened nuts and lock washers from the assembled Megafuses, then using the drawing on page 3 as a guide, install your pre-assembled wires from steps 2-4 above. Re-install the 4 nuts and lock washers onto the assembled Megafuses and tighten them down. This part of your installation is now complete.

**510476**

**Z**

DESCRIPTION:

**Alternator and Main Power  
Connection Kit  
Various Applications**

92972153 instruction sheet rev 0.1 6/24/2019

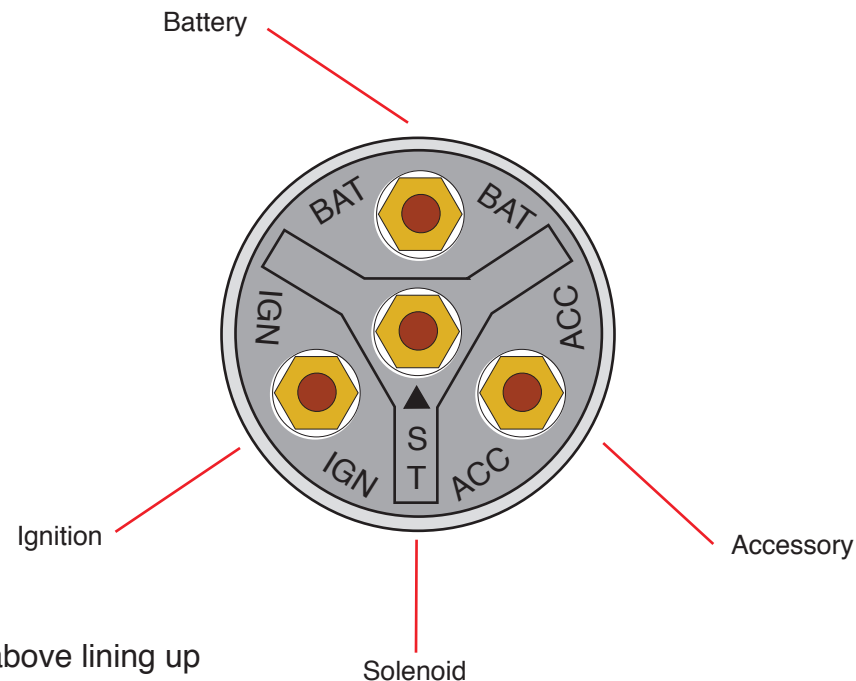
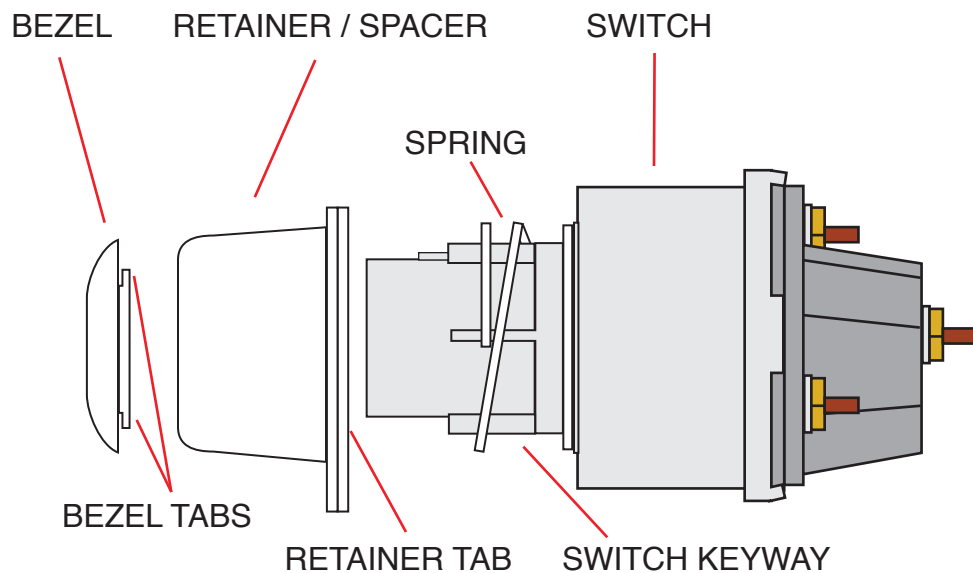

#### SWITCH ASSEMBLY DIRECTIONS:

1. Push the retainer / spacer down onto the switch assembly as shown above lining up the tab on the retainer with the keyway on the switch.
2. From behind the dash, push the switch and retainer assembly through the opening in the face of the dashboard compressing the spring on the switch so that the front edge of the switch comes through the dashboard opening.
3. With the spring compressed and the switch protruding through the opening in the dash, press the bezel into the face of the switch aligning the two tabs on the bezel with the openings in the face of the switch, twist the bezel 1/4 turn to your right which will lock the tabs into the switch, release the pressure on the spring where you were pushing the switch assembly through the opening in the dash from behind, and the entire assembly will lock into place.

#### DASH HARNESS CONNECTIONS:

1. Attach the red "12V BAT" wire to the "BAT" stud; attach the pink "IGNITION FEED" wire to the "IGN" stud; attach the purple "NEUTRAL SAFETY SWITCH" wire to the "ST" stud; attach the brown "IGNITION SW ACCY" wire to the "ACC" stud. **NOTE:** If you are using an alternator other than a self-exciting 1 wire unit, please refer to the detailed instructions on page 4, branch 4, of the 92969976 instructions to properly connect the small gauge small brown or brown with white stripe wires as these are the field exciters for a normal alternator regulator circuit.



150 Heller Pl #17 W Bellmawr, NJ 08031 856-933-0801

PART #

# 510309

DESCRIPTION:

Ignition Switch  
1953-1956 Ford Truck  
Classic Update Series

92969996 instruction sheet rev 0.0 1/31/2012

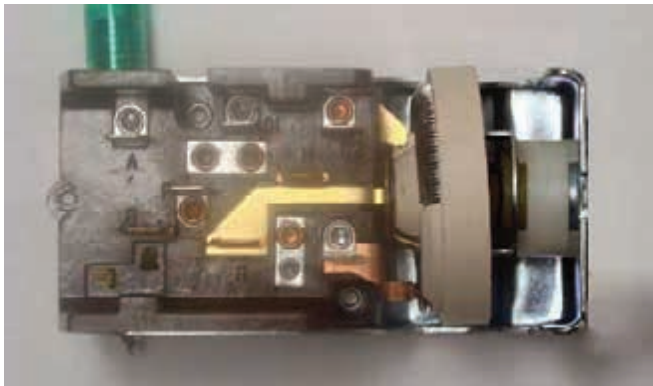
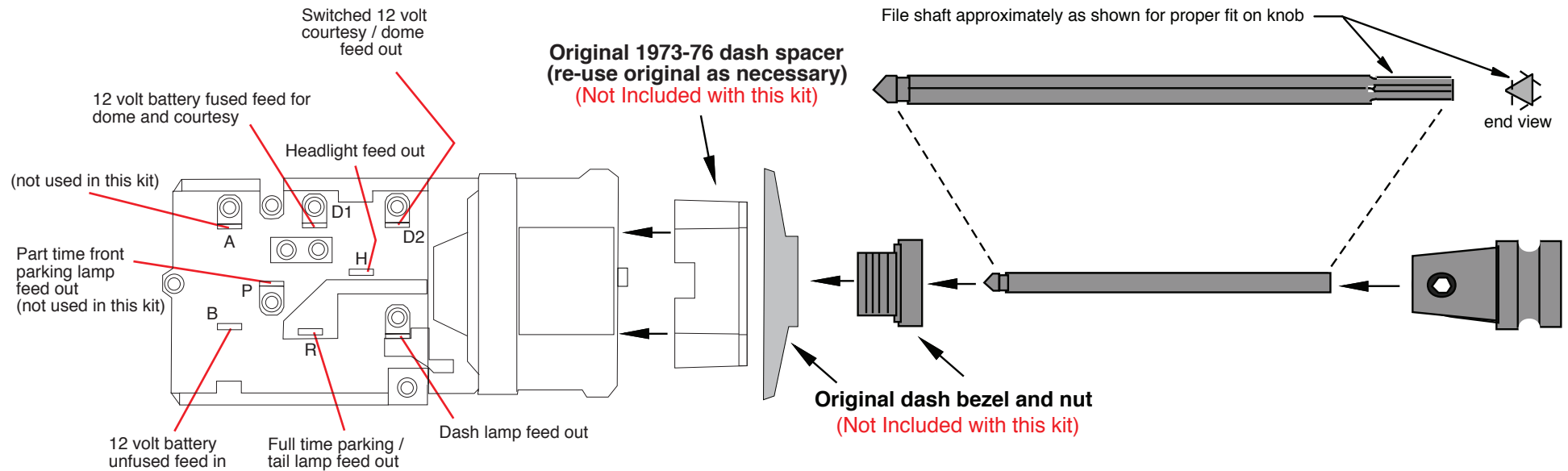

**NOTE 1:** If you are using this new AAW switch in a 1953-55 Ford Truck that originally used a 6 volt switch, you will find that the threaded area on your original nut is too small in diameter. You will need to purchase a new 1956 12 volt style replacement nut which is larger in diameter and will fit this new AAW switch and still allow for the use of your stock dash bezel. These are readily available from your favorite truck parts supplier.

**NOTE 2:** If you are using this new AAW switch for a 1973-76 Ford Truck application, it may be necessary to remove and re-use the dash spacer shown above from your original switch (most are only affixed with double faced tape from the factory), especially if you are planning to use your original shaft and knob assembly. Please check the harness to switch connection for dash clearance issues.

1. Install the new switch into your dash using the original bezel and nut. It will be necessary too cut the shaft for a nice custom installation.
2. Install the shaft in switch being certain that it is fully engaged inside the switch. Once the shaft is fully seated down inside the switch in the "off" position, place the knob on end of shaft. Measure how far away from the dash the bottom face of the knob (closest to dash) is. Allow for 1/4" or so extra so that the knob will not bottom out on dash once the shaft has been cut to length.
3. Remove the shaft from the switch. To do this, pull the shaft completely out to the "on" position. Reach up under the dash and depress the button on top of the switch and pull the shaft out of the switch. Cut the shaft based on your measurements. It may be necessary to file the end of the shaft once it has been cut in order to reinstall the knob onto the shaft.
4. Attach the knob to the cut shaft and tighten the allen screw.
5. Reinstall your newly customized shaft into your headlight switch assembly.



**American  
Autowire**

www.americanautowire.com 856-933-0801

PART #

**510264**

DESCRIPTION:

Headlight Switch 1953-56,  
1961-66 & 1973-79 Ford Truck  
Classic Update Series

92969840 instruction sheet rev 3.0 1/15/2013

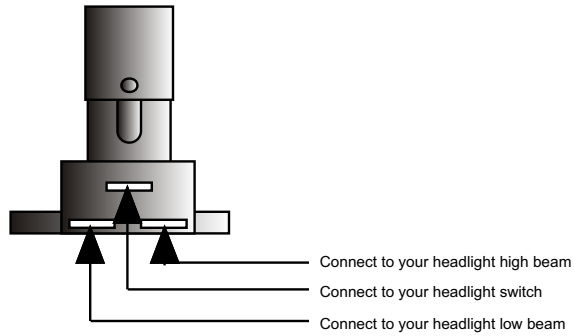

Connect the Dimmer Switch wires as shown above.

1. The top center terminal of the Dimmer Switch is connected to the Headlight switch.
2. The terminal on the right side is connected to your headlight high beam terminal.
3. The terminal on the left side is connected to your headlight low beam terminal.

another wiring product by...



150 Heller Pl #17 W Bellmawr, NJ 08031 856-933-0801

PART #

**500042**

DESCRIPTION:

**DIMMER SWITCH**

92964573 instruction sheet Rev 3.0 6/29/99

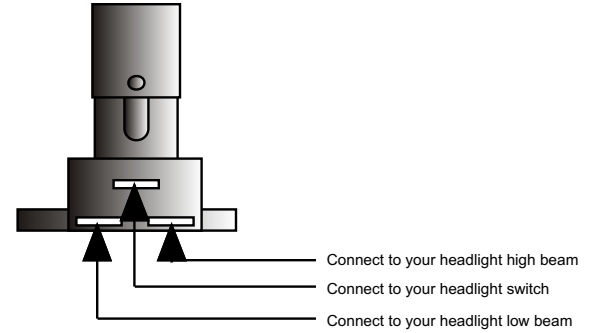

Connect the Dimmer Switch wires as shown above.

1. The top center terminal of the Dimmer Switch is connected to the Headlight switch.
2. The terminal on the right side is connected to your headlight high beam terminal.
3. The terminal on the left side is connected to your headlight low beam terminal.

another wiring product by...



150 Heller Pl #17 W Bellmawr, NJ 08031 856-933-0801

PART #

**500042**

DESCRIPTION:

**DIMMER SWITCH**

92964573 instruction sheet Rev 3.0 6/29/99