

**NOTE:** If the fuse panel on your 510034 '70-'73 Camaro kit **HAS** a sticker like the photo at the left, you have the second design harness and your instructions are listed below and follow this page.

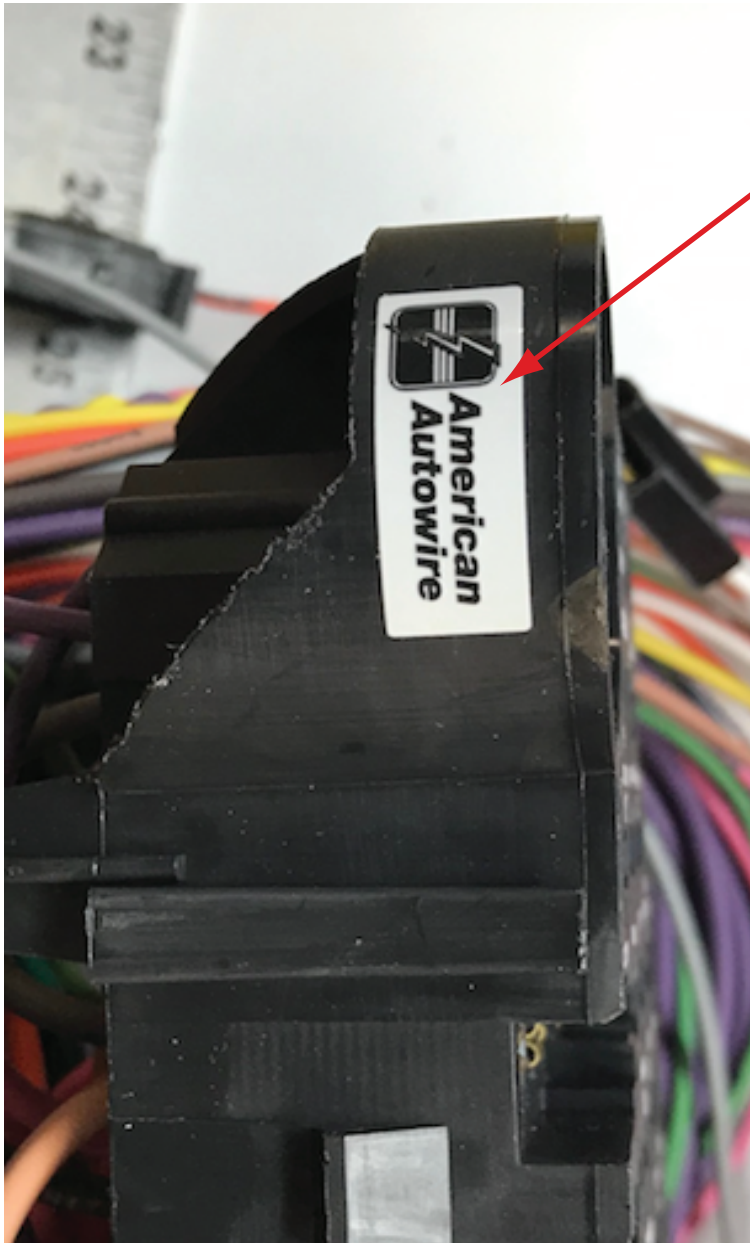

Number	Description
500332	Headlight Switch
500707	Fuse, Relay, and Flasher kit
500708	Courtesy Light kit
500919	Practice Terminal Crimping Set
510514	Dash Harness kit
510510	Engine Wiring Kit
510511	Front Light Wiring kit
510515	Instrument Cluster Wiring kit
510043	Console Wiring kit
510042	Rear Body Wiring kit
510476	Alternator and main power Connection kit
510730	VSS Connection kit
500042	Floor Dimmer Switch
92972494	Kit Introduction Instruction Sheet
92972495	Warning Sheet



www.americanautowire.com 856-933-0801

## 70-73 Camaro Second Design Instructions

92972872 rev. 0.0 1/27/2020



## WARNING:

Validate the kit contents with the component list included on page 2 of this sheet before proceeding. This kit is intended to be used in a modified vehicle. Please read this sheet thoroughly and be sure that you understand everything explained on it prior to opening any of the enclosed packages, or before attempting to install any of the components. Once this kit has been opened or a component installed, the kit is not returnable.

1. This kit should typically be used in a **MODIFIED** application only.
2. This kit supports the use of factory heater systems and aftermarket heater and A/C systems. The kit supplies power to a factory A/C control head but **DOES NOT** include the actual A/C harness for an original factory A/C vehicle. Factory original A/C harnesses are available under our Factory Fit product line as they are self contained harnesses made to fit and work with the stock A/C component configuration.
3. This kit supports the use of a high current self-exciting 1-wire alternator or other style internally regulated alternators. An adapter may be necessary in some applications. The use of a stock, low amperage alternator is seriously discouraged as they cannot handle the higher current requirements of updated ignition systems, electric fans, aftermarket A/C systems, stereo systems, air ride suspensions, and other power hungry accessories and will ultimately create performance issues with the system.
4. This kit **WILL NOT** support the use of a factory ammeter. All AAW kits are engineered to supply the optimum charge to the battery. To achieve this performance, we route our 6ga. charge wire directly from the alternator output charge terminal to the starter battery terminal. Due to the path of the charge being altered from the stock configuration, the gauge can no longer see a charge vs. a discharge, so it will not work properly. When ammeters were originally used, most generator or alternator current outputs were rated at a maximum of about 25-60 amps. Modified cars being built today typically utilize a 100 amp or higher output alternator. With these higher current units, ammeters, generally speaking, become a safety hazard. Ammeters are usually wired in parallel to the charging circuit, are typically unfused, and can short very easily causing a fire. A voltmeter is recommended as a good alternative.
5. This kit **IS NOT** set up with a resistance wire for a standard, points type ignition system. It is wired with a full 12 volt primary ignition feed that is hot in the run position. Primary ignition voltage in the starting position is handled via a full 12 volt bypass wire. Our system will support HEI, MSD, other electronic ignition systems, as well as most all computerized Fuel Injection systems. If you wish to run a points type system, there are illustrations on the engine connection pages to do so. Extra parts (ballist resistor) that are not included in this kit will be required to complete that operation.



# 510034

# 510034 - Classic Update Series Kit 1970-73 Chevrolet Camaro

This kit contains the following components:

<u>Bag</u>	<u>Part Number</u>	<u>Description</u>	<u>Quantity</u>
	500042	Floor Dimmer Switch	1
	500332	Headlight Switch	1
J	510510	Engine Wiring Kit	1
L	510511	Front Light Wiring kit	1
	500707	Fuse, Relay, and Flasher kit	1
N	500708	Courtesy Light kit	1
	500919	Practice Terminal Crimping Set	1
G	510514	Dash Harness kit	1
M	510042	Rear Body Wiring kit	1
K	510043	Console wiring kit	1
H	510515	Instrument Cluster wiring kit	1
Z	510476	Alternator and Main Power Connection kit	1
V	510730	VSS Connection Kit	1
	92972494	Kit Introduction Instruction Sheet	1
	92972495	Warning Sheet	1

Validate the kit contents with this component list. If there are any discrepancies with incorrect or missing parts, stop your installation and notify the supplier you purchased the kit from before proceeding.



www.americanautowire.com 856-933-0801

# 510034

92972495 instruction sheet Rev 0.0 8/1/2019

# Classic Update Series

1970-73 Camaro

1970-73 Firebird

## START HERE !

PLEASE READ THIS BEFORE STARTING INSTALLATION !

This wiring kit is designed for ease of installation. Please read the guidelines below, BEFORE STARTING your installation, to guarantee a successful job! Use an appropriate crimping tool which folds the crimp wings on the terminals as shown below. Top quality crimping tools are available from American Autowire or American Autowire authorized dealers.

**NOTE: ALL TERMINALS THAT YOU INSTALL SHOULD BE PROPERLY SOLDERED.**

Our factory terminations are installed by GM approved termination presses, and soldering is not necessary on these terminations.



### STEP 1: DISCONNECT YOUR BATTERY:

Disconnect the battery before installing the wiring kit to prevent any accidental shorting caused by loose bare wire ends.

### STEP 2: START INSTALLING KIT:

This kit is broken down into individual steps that are identified by a letter printed on the instruction sheets visible through each bag. These letters are the order of operation for installing your kit. Start with the bag letter G, then H, etc. The order of installation is shown below.

G 510514 Dash Harness Kit  
P 510515 Instrument Cluster Kit  
J 510510 Engine Kit  
K 510043 Console Kit  
L 510511 Front Light Kit  
M 510042 Rear Body Kit  
N 500708 Courtesy Light Kit  
V 510730 VSS Connection Kit  
Z 510476 Alternator and Main Connection Kit

### STEP 3: RECONNECT YOUR BATTERY:

When you have completed the installation and are ready to reconnect the battery, make sure that the following electrical system grounds are in place:

- A. Battery is grounded to the ENGINE BLOCK.
- B. Battery is grounded to the frame.
- C. Engine block is grounded to the frame.
- D. Body is grounded to the frame.

### STEP 4: CHECK ALL ELECTRICAL FUNCTIONS:

Any non-functioning items should be checked for proper installation. Any problems with your wiring and electrical circuit functions should be addressed to American Autowire Systems, Inc. as soon as possible to avoid any warranty problems.

If you have any questions concerning this or any of our products, please feel free to call us at 1-856-933-0801.

AMERICAN AUTOWIRE MAKES IT EASY !!

We carry many accessories for your 1970-73 Camaro

p/n R0067108  
OEM style non-stick harness tape.



p/n 01997938 (1969-76)  
OEM style turn signal switch.

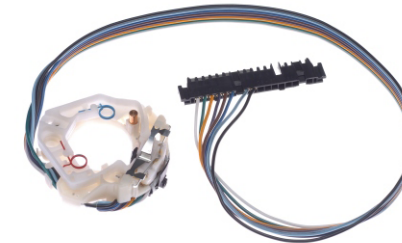

p/n 38131  
Breakerless Ignition Module,  
GM V-8 POINT CONVERSION KIT.



p/n 03943657 (1969-72)  
Muncie 4 speed back up lamp switch.

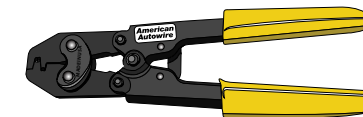
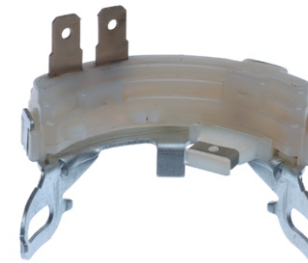

p/n 510585  
Multi-crimp tool (20-14 gauge).

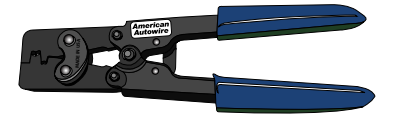

p/n 510586  
OEM large terminal and double  
crimping tool (20-8 gauge).

p/n 36281 (1970)  
p/n 36282 (1971)  
p/n 36283 (1972)

Factory assembly manuals.  
(It's what they used on the assembly  
line to build your Camaro!)

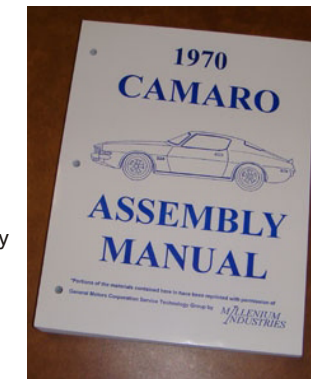

www.americanautowire.com

## Classic Update Series

1970-73 Camaro

1970-73 Firebird

# 510034

© COPYRIGHT 2004 American Autowire / Factory-Fit  
Used with express permission of  
American Autowire / Factory-Fit  
92972494 instruction sheet rev. 1.0 08/25/2023

# Classic Update Series

1970-73 Camaro/Firebird



www.americanautowire.com

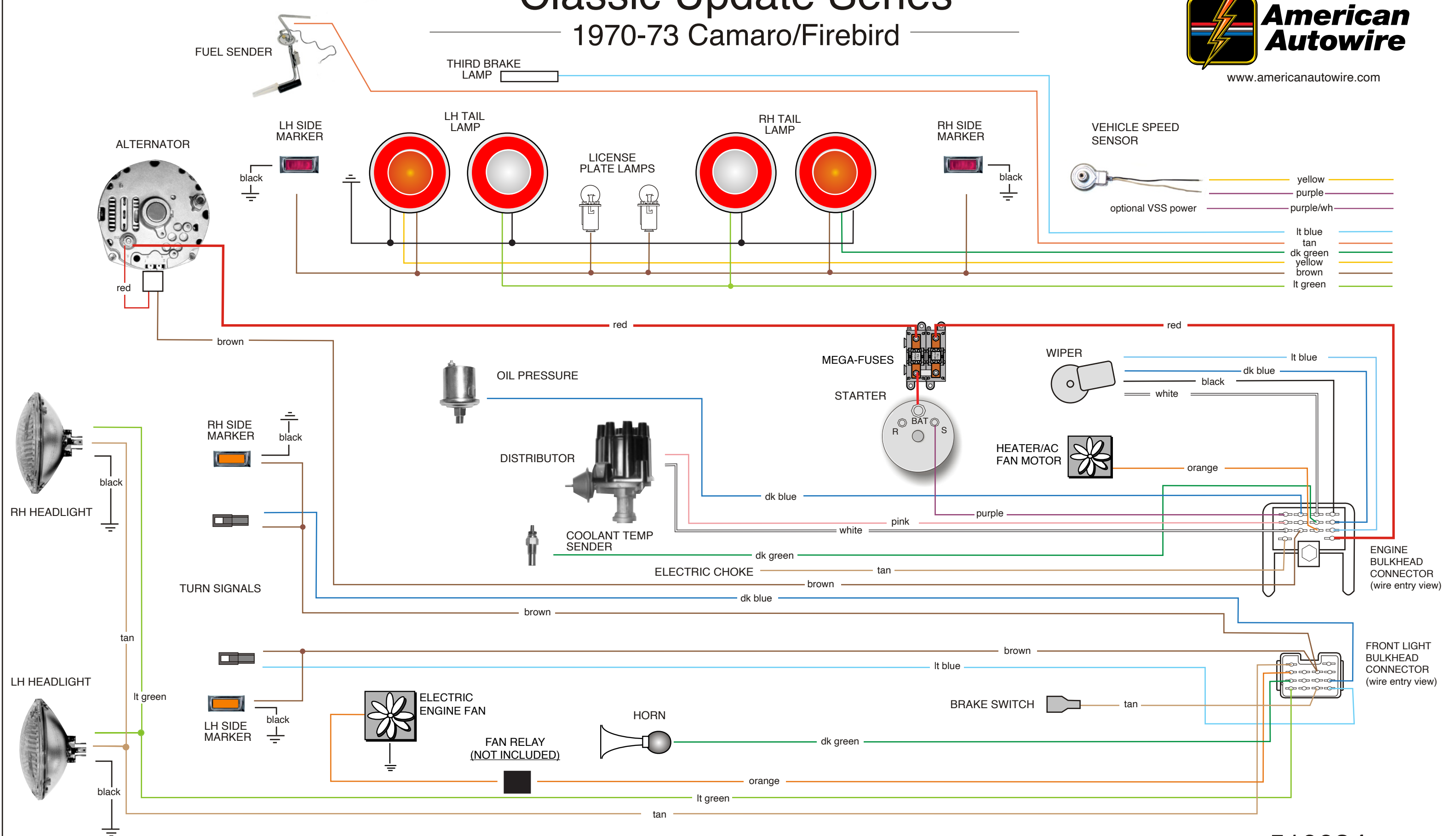

NOTICE: This schematic drawing is for reference only. Do not use the schematic to install this wiring kit! Use the instruction sheets included in each bag, which includes directions for proper terminations, and specific applications.

510034

© COPYRIGHT 2004 American Autowire / Factory-Fit  
Used with express permission of American Autowire / Factory-Fit  
92972494 instruction sheet rev. 1.0 08/25/2023



www.americanautowire.com

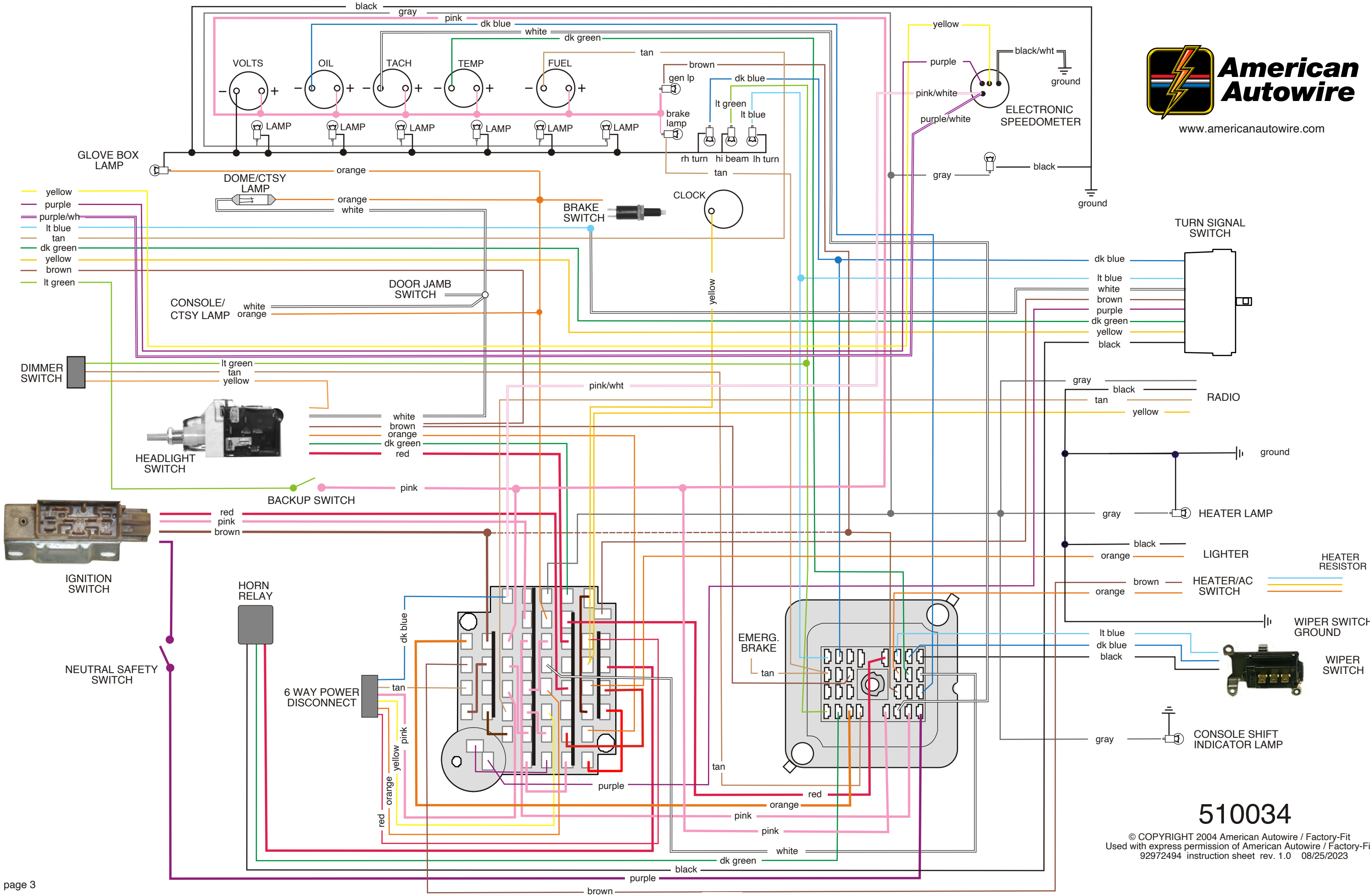

510034

© COPYRIGHT 2004 American Autowire / Factory-Fit  
Used with express permission of American Autowire / Factory-Fit  
92972494 instruction sheet rev. 1.0 08/25/2023

THIS PAGE HAS BEEN INTENTIONALLY LEFT BLANK



510034

© COPYRIGHT 2004 American Autowire / Factory-Fit  
Used with express permission of American Autowire / Factory-Fit  
92972494 instruction sheet rev. 1.0 08/25/2023

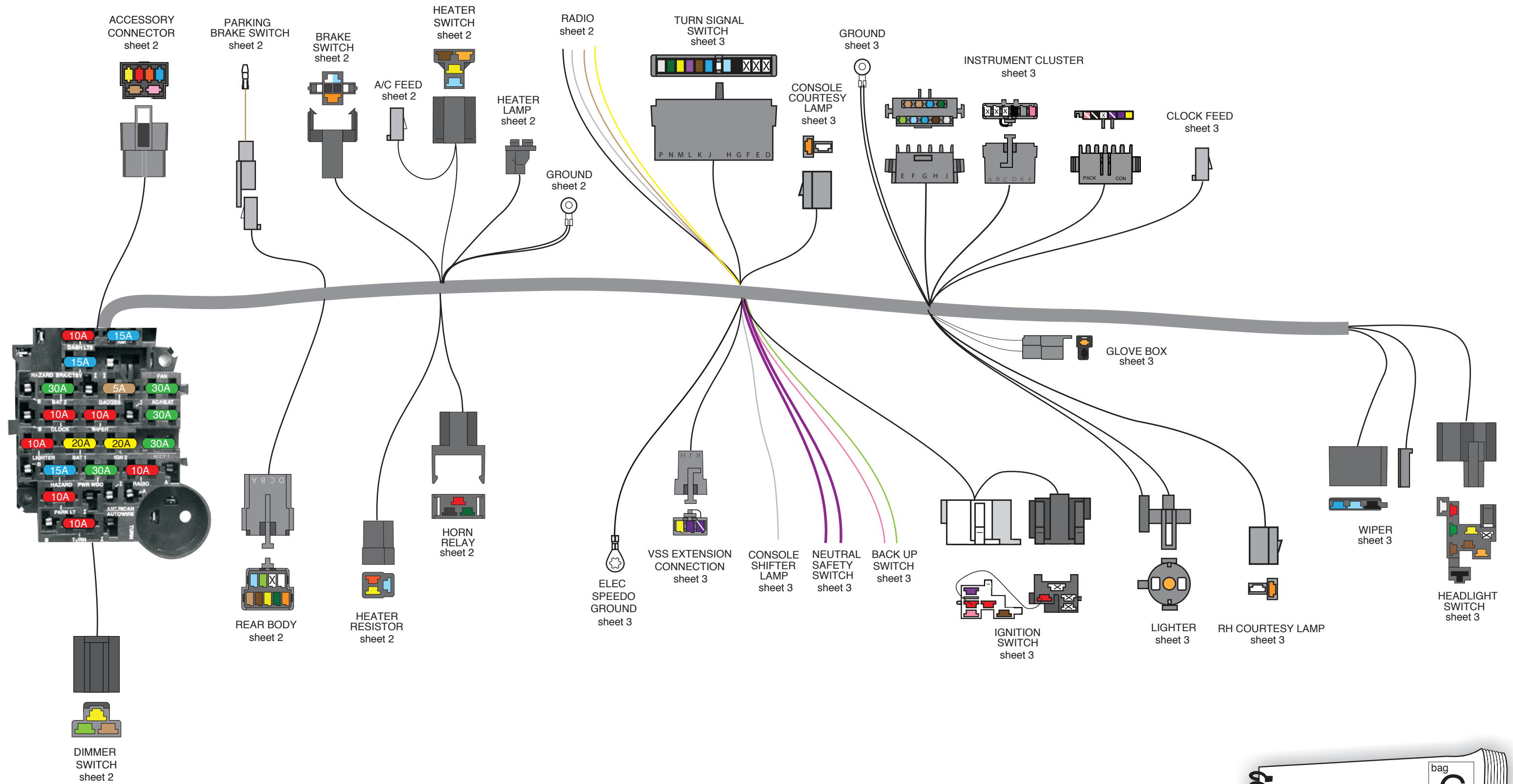

**American  
Autowire**

www.americanautowire.com 856-933-0801





# INSTALLING THE FUSE BOX

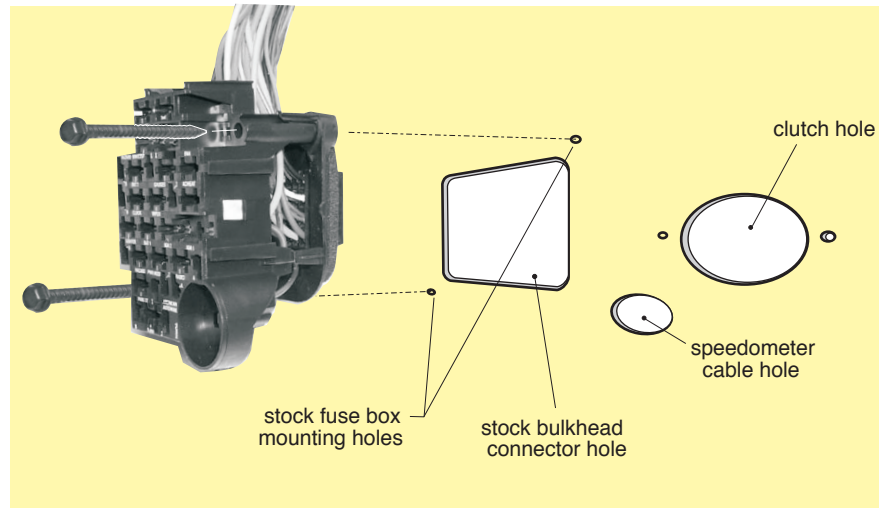

1. Locate the stock OEM bulkhead hole in the driver side of the firewall.
2. Mount the fuse box with the flasher can in the bottom right corner, as shown above.
3. Using the two mounting screws A, attach the fuse panel to the firewall.

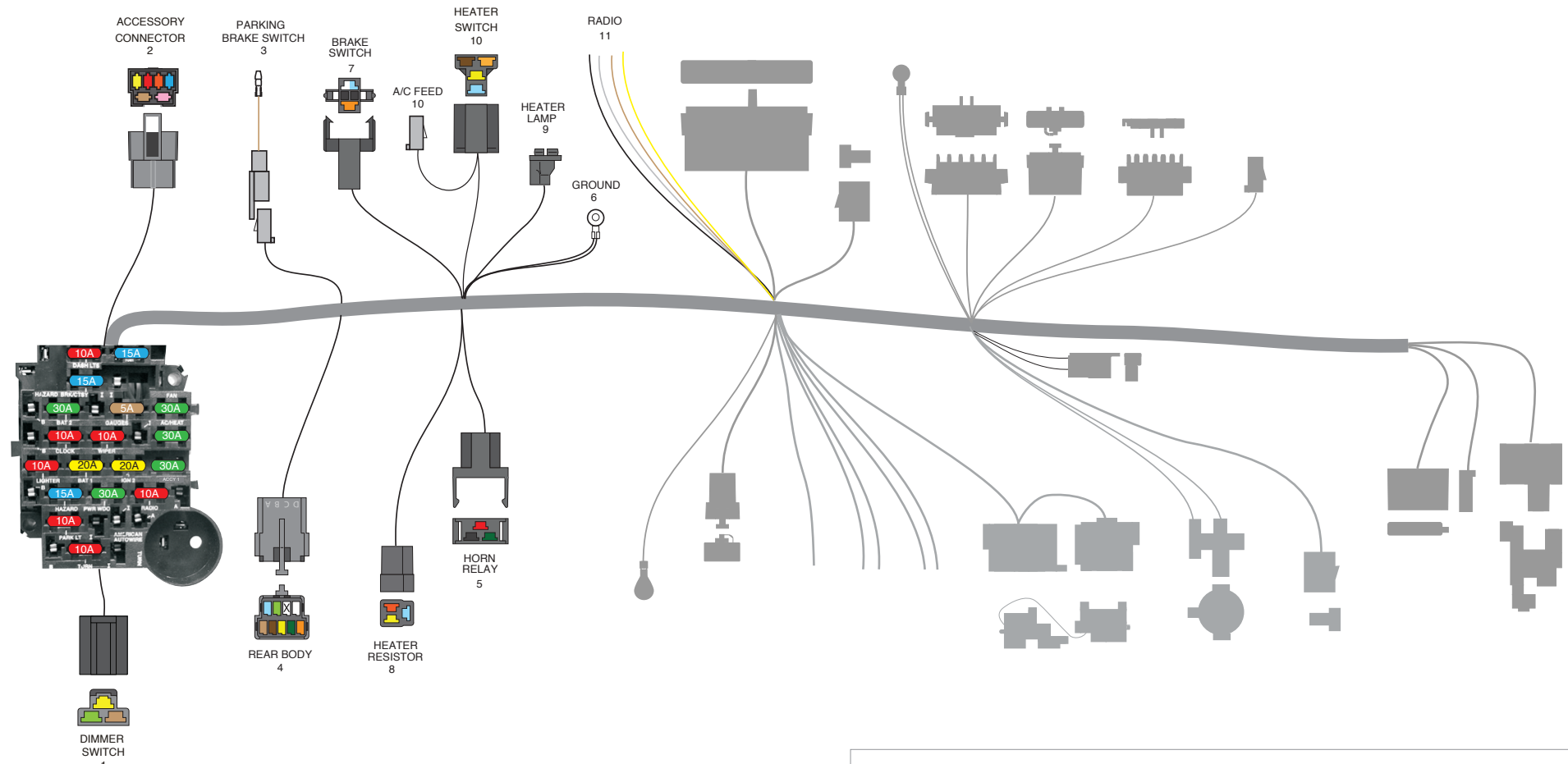

- |                  |  |  |
|------------------|--|--|
| 1. DIMMER SWITCH | Light Green (thin wire)<br>Light Green (heavy wire)<br>Tan<br>Yellow | High beam indicator light in the instrument cluster.<br>Headlight high beam feed wire out.<br>Headlight low beam feed wire out.<br>Headlight power feed wire in from headlight switch. |
|------------------|--|--|

- |                |  |  |
|----------------|--|--|
| 2. ACCESSORIES | Use the provided connector J and terminals as power leads for the following: |  |
|                | Tan  | FUEL 15 amp Fused 12 volt IGNITION feed for fuel pump (may also be used to feed power to another ignition circuit).        |
|                | Orange   | BAT1 20 amp Fused 12 volt BATTERY feed for power seats (may also be used to feed power to another battery circuit).        |
|                | Red  | BAT2 30 amp Fused 12 volt BATTERY feed for power door locks (may also be used to feed power to another accessory circuit). |
|                | Pink   | IGN1 20 amp Fused 12 volt IGNITION feed for cruise control (may also be used to feed power to another ignition circuit).   |
|                | Pink   | PWRWDO 30 amp Fused 12 volt IGNITION feed for power windows (may also be used to feed power to another ignition circuit).  |
|                | Dark Blue  | ACCY1 30 amp Fused 12 volt ACCESSORY feed (may also be used to feed power to an accessory circuit).                        |

- |                  |     |   |
|------------------|-----|---|
| 3. PARKING BRAKE | Tan | Connect to the parking brake switch. This is the ground circuit for the parking brake switch light. |
|------------------|-----|---|

- |              |  |                               |
|--------------|--|-------------------------------|
| 4. REAR BODY | This connector will mate to the connector from the Rear Body harness found in bag M. |                               |
|              | Tan  | Fuel tank sender lead.        |
|              | Brown  | Tail lamp feed.               |
|              | Yellow   | Left Hand turn / brake feed.  |
|              | Dark Green   | Right Hand turn / brake feed. |
|              | Orange   | Dome / courtesy lamp feed.    |
|              | White  | Dome / courtesy lamp ground.  |
|              | Light Green  | Back up lamp feed.            |
|              | Light Blue   | Third brake light.            |

- |               |  |  |
|---------------|--|--|
| 5. HORN RELAY | Plug the horn relay (found in the fuse bag) into this connector. |  |
|               | Red  | 12 volt battery.                           |
|               | Black  | Relay ground circuit (to steering column). |
|               | Dark Green   | Triggered 12 volts to horn.                |

- |           |       |  |
|-----------|-------|--|
| 6. GROUND | Black | Connect to a good chassis ground. This must be a unique ground point different from the Electric Speedo Ground #15 |
|-----------|-------|--|

- |                 |  |   |
|-----------------|--|---|
| 7. BRAKE SWITCH | Plug this connector onto the factory brake switch. |   |
|                 | Orange   | 12 volt feed 'in' to switch.                  |
|                 | White  | 12 volt feed 'out' to steering column switch. |
|                 | Light Blue   | 12 volt feed 'out' to third brake light.      |

- |                    |   |  |
|--------------------|---|--|
| 8. HEATER RESISTOR | Plug this connector onto the factory heater resistor located on top of the heater box of all non-A/C equipped cars. |  |
|--------------------|---|--|

- |                   |   |   |
|-------------------|---|---|
| 9. HEATER LAMP    | Gray  | Heater control panel lamp.  |
| 10. HEATER SWITCH | Plug this connector into the factory heater switch. |   |
|                   | Brown   | 12 volt accessory feed to heater / ac switch (if using aftermarket a/c, use the short brown wire as the accessory feed wire to a/c harness. If a new A/C harness is needed, please order our p/n CA01578 (1970), CA11893 (1971), CA28040 & (1972), 37801 or 37799 (1973) separately.) |
|                   | Yellow  | Heater resistor.  |
|                   | Light Blue  | Heater resistor.  |
|                   | Orange  | Heater resistor.  |

- |           |        |  |
|-----------|--------|--|
| 11. RADIO | Tan    | Radio accessory feed. ("on" "off" power wire for stock radio). |
|           | Black  | Radio ground.  |
|           | Gray   | Radio lamp.  |
|           | Yellow | Radio 12 volt clock and memory lead (battery feed).            |

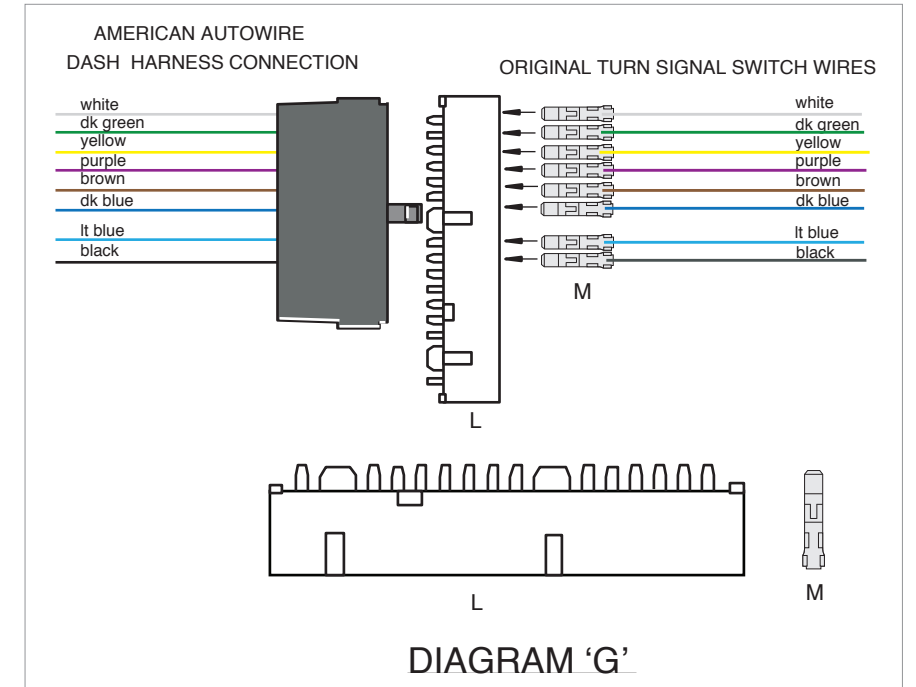

**American  
Autowire**

1970-73 Camaro  
**DASH KIT  
510514**

12. CONSOLE CTRSY LAMP These wires are for use on a console vehicle.  
For wire functions, refer to bag K, 510043.  
White Connects to dome light ground circuit.  
Orange Connects to the Brake and courtesy fused circuit.
13. CONSOLE SHIFTER LAMP Gray Shift quadrant PRNDLL lamp.
14. TURN SIGNAL SWITCH This harness has a connector on it for the 3-7/8" 1969-1976 GM column connection used by GM and many after-market manufacturers.  
If using a late model GM steering column or an after-market column that uses the 4-1/4" GM turn signal connector, replace existing connector with connector L, matching wires by color (see detail diagram "G" on sheet 2).  
White 12 volt feed from brake switch.  
Dark Green RH stop and turn.  
Yellow LH stop and turn.  
Purple 12 volt feed from turn flasher.  
Brown 12 volt feed from hazard flasher.  
Dark Blue RH turn.  
Light Blue LH turn.  
Black Horn relay ground wire to horn switch.
15. ELEC. SPEEDO GROUND Black / White Connect to a good chassis ground. This must be a unique ground point different from the main dash harness ground #'s 6 and 20.
16. VSS EXTENSION CONNECTION These wires are for use with an aftermarket electric speedometer only. The VSS lead wires, in 510730, bag V, will plug on here. Refer to that instruction sheet for wire functions and additional directions.
17. NEUTRAL SAFETY SWITCH Connect these wires to the neutral safety switch on the column or floor shifter, or clutch pedal.  
Purple 12 volt feed 'in' to neutral safety switch from ignition switch.  
Purple 12 volt feed 'out' to starter solenoid.
18. BACK UP SWITCH Connect these wires to the back up switch on the column or floor shifter.  
Pink 12 volt ignition feed 'in' to back up lamp switch.  
Lt Green 12 volt feed 'out' to back up lamps.
19. IGNITION SWITCH Note: Connectors are included if you are using a stock 1970-73 Camaro ignition switch as shown in Diagram H.  
Red 12 volt battery feed in.  
Pink 12 volt ignition feed out.  
Brown 12 volt accessory feed out.  
Purple Starter lead wire to Neutral Safety Switch out.
20. GROUND Black Connect to a good chassis ground. This must be a unique ground point different from the Electric Speedo Ground #15
21. INSTRUMENT CLUSTER DISCONNECTS These connectors will plug into the gauge disconnect harness from bag H. Wire identifications are described on the Instruction sheets from bag H.
22. RH COURTESY LAMP Plug this connector into the mating connector from the courtesy lamp kit bag N, 500708.  
Orange 12 volt battery feed for lamp  
White Ground circuit for lamp
23. GLOVE BOX LIGHT Orange Connect to the original factory glove box lamp switch connector (battery feed).  
Black Connect to the original factory glove box lamp switch connector (ground).  
If not using, no other operation is necessary.
24. LIGHTER Orange Connect to lighter. (battery feed)BlackConnect to lighter (ground).
25. WIPER Note: See detailed photo at right on this sheet.  
Black Ground circuit for low speed. (in 3 way connector)  
Dk Blue Ground circuit for washer. (in 3 way connector)  
Lt Blue Ground circuit for hi speed. (in 3 way connector)  
Black Ground for switch assy. (single wire used in 72-73 Camaro only)
26. HEADLIGHT SWITCH Red 12 volt feed 'in' to switch 'BAT' location on headlight switch  
Orange 12 volt feed 'in' to park/tail' 'PARK / TAIL FEED IN' location on headlight switch. (commonly found on GM headlight switches)  
Browns Park / tail lamp feeds 'out' 'PARK/ TAIL LAMP OUT' location on headlight switch.  
Yellow Dimmer switch feed 'out' 'DIMMER FEED' location on headlight switch.  
Dk Green Instrument lamp feed 'out' 'INSTRUMENT LAMP' location on headlight switch.  
White Dome / courtesy ground 'GROUND' location on headlight switch.  
Black Switch body ground 'GROUND' for headlight switch assembly.

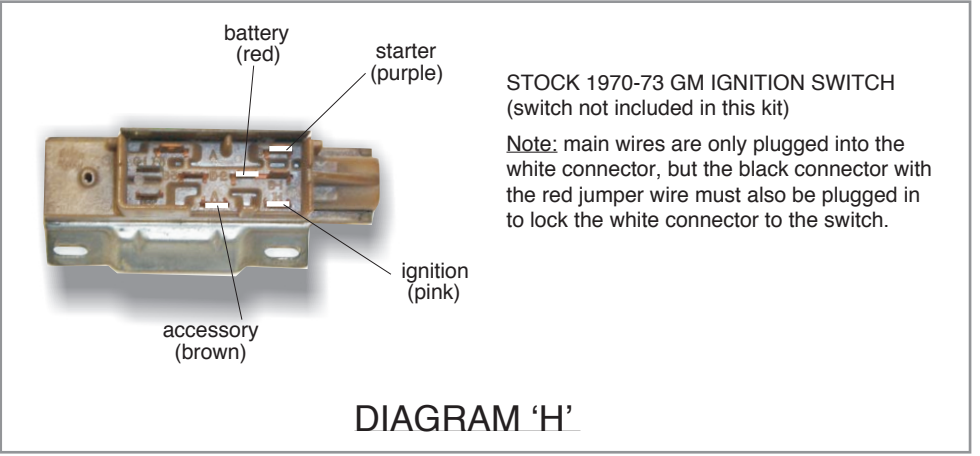
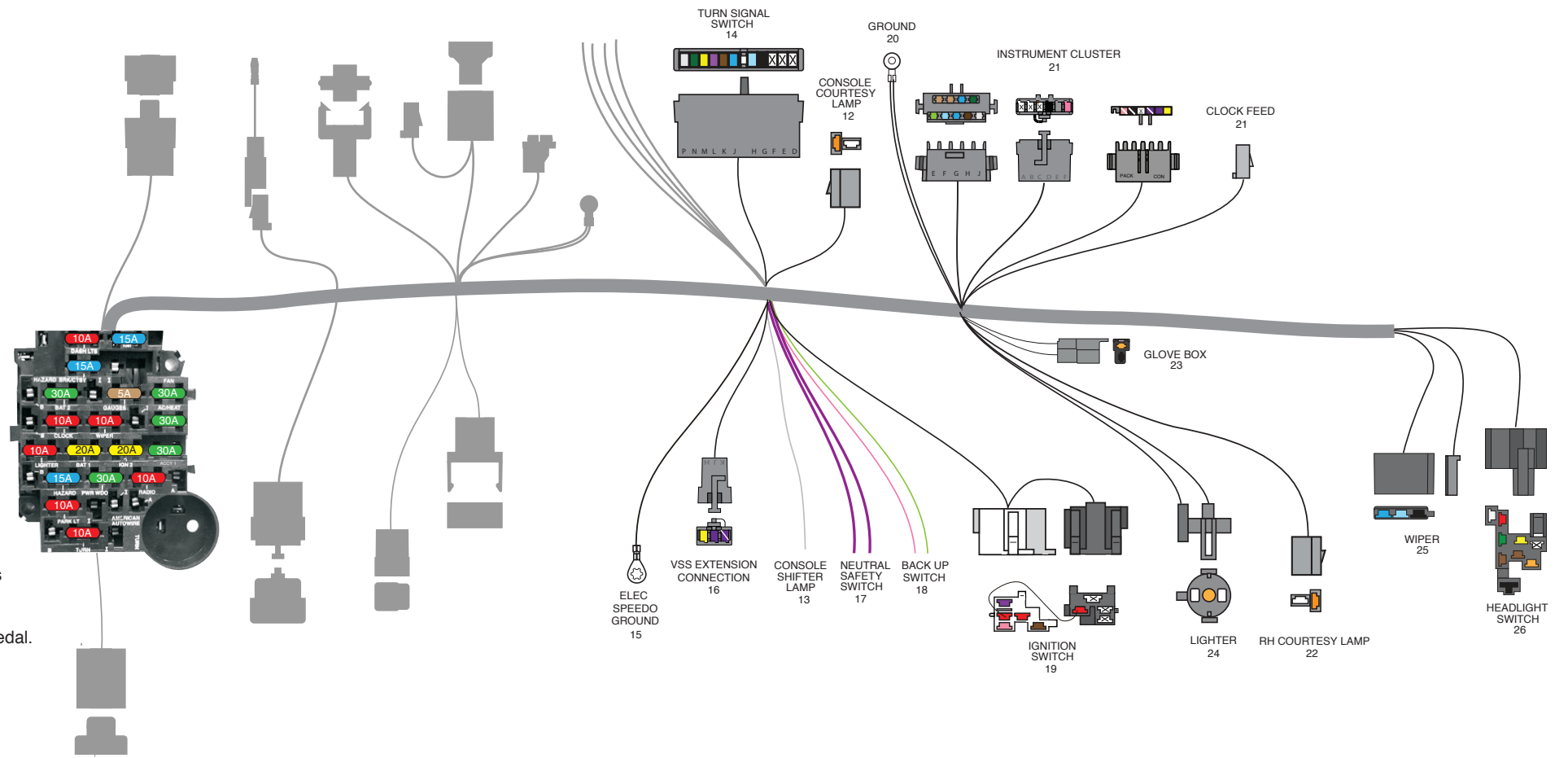

STOCK 1970-73 GM IGNITION SWITCH (switch not included in this kit)  
Note: main wires are only plugged into the white connector, but the black connector with the red jumper wire must also be plugged in to lock the white connector to the switch.

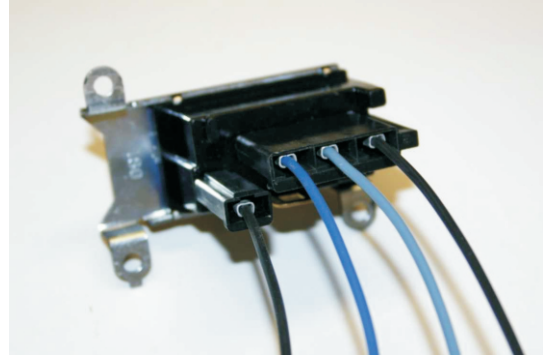

The above picture shows the orientation for wiper switch hook-up only. All other applications can only be plugged in one way.



1970-73 Camaro  
**DASH KIT**  
**510514**

THIS PAGE HAS BEEN  
INTENTIONALLY LEFT BLANK



[www.americanautowire.com](http://www.americanautowire.com) 856-933-0801

1970-73 Camaro  
DASH KIT  
**510514**

92972489 instruction rev 0.0 8/1/2019

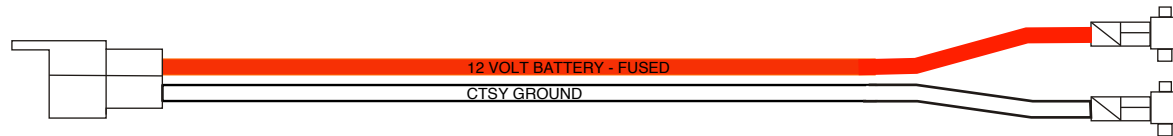

If you have a 1970-72 model Camaro, plug this console rear courtesy lamp extension into the mating connector at location #13 on page #3 on your dash harness (510033).



**American  
Autowire**

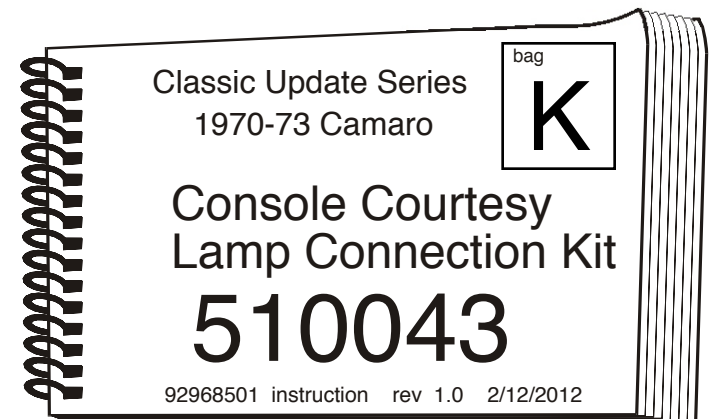

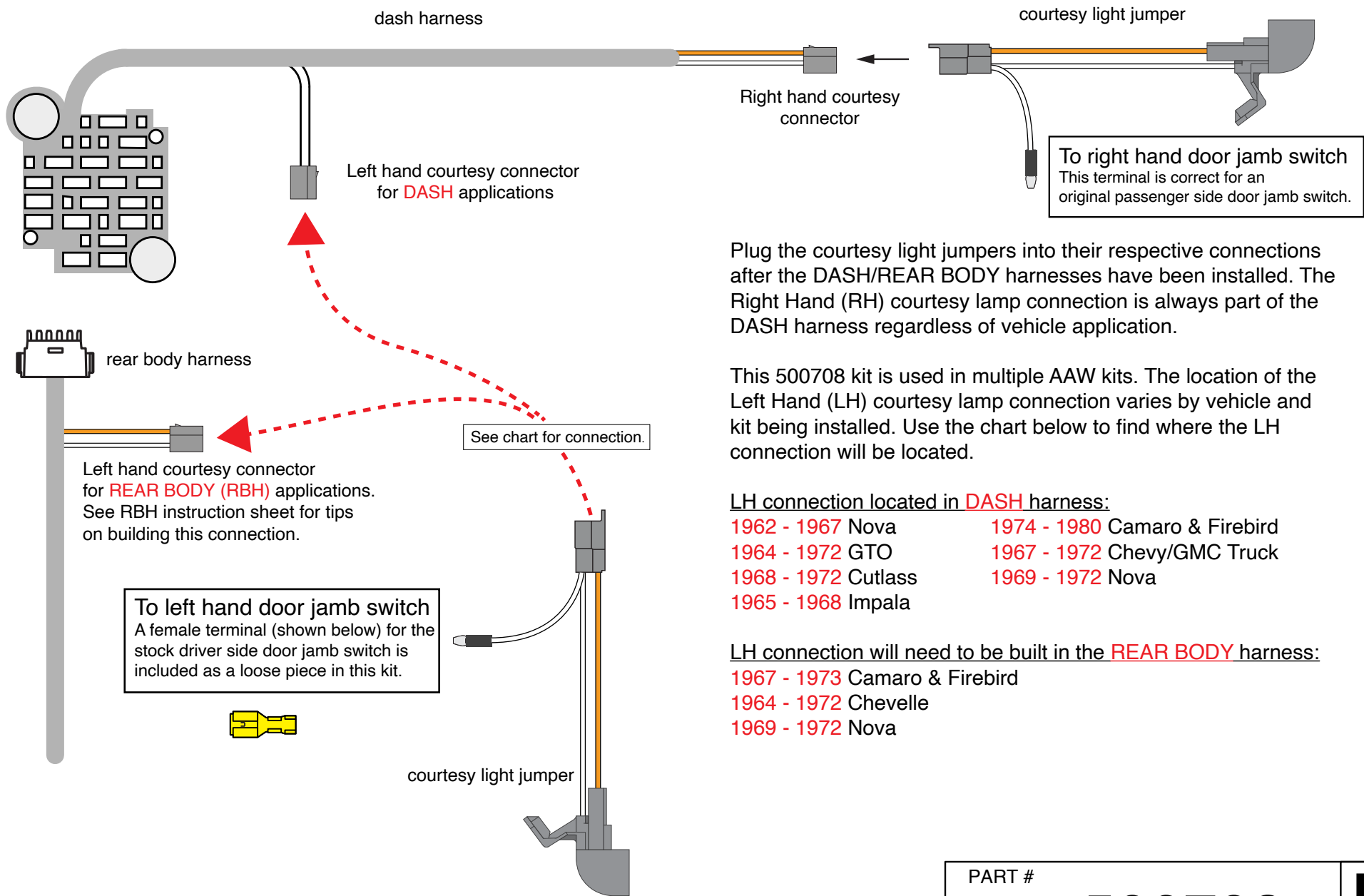

Plug the courtesy light jumpers into their respective connections after the DASH/REAR BODY harnesses have been installed. The Right Hand (RH) courtesy lamp connection is always part of the DASH harness regardless of vehicle application.

This 500708 kit is used in multiple AAW kits. The location of the Left Hand (LH) courtesy lamp connection varies by vehicle and kit being installed. Use the chart below to find where the LH connection will be located.

LH connection located in **DASH** harness:

- |                     |                               |
|---------------------|-------------------------------|
| 1962 - 1967 Nova    | 1974 - 1980 Camaro & Firebird |
| 1964 - 1972 GTO     | 1967 - 1972 Chevy/GMC Truck   |
| 1968 - 1972 Cutlass | 1969 - 1972 Nova              |
| 1965 - 1968 Impala  |                               |

LH connection will need to be built in the **REAR BODY** harness:

- |                               |
|-------------------------------|
| 1967 - 1973 Camaro & Firebird |
| 1964 - 1972 Chevelle          |
| 1969 - 1972 Nova              |

**BULB INFO:** Your new underdash courtesy light kit uses # **631** bulbs (not included with this kit). They may be purchased at any auto parts store.



**American  
Autowire**

www.americanautowire.com 856-933-0801

PART #

**500708**

**N**

DESCRIPTION:

Courtesy Light Kit

92966085

Rev 2.0 JDM

02/10/2023

# Classic Update Series

REFER TO SHEET 2 FOR CONNECTING TO A STOCK INSTRUMENT CLUSTER. IF USING A FACTORY DASH CIRCUIT BOARD, BE SURE TO INSTALL THE WIRES AS SHOWN FOR WARNING LIGHTS OR, FACTORY GAUGES.  
REFER TO SHEET 3 IF YOU ARE INSTALLING AFTERMARKET GAUGES, TERMINAL KIT 92965220 HAS BEEN PROVIDED TO CONNECT THIS CLUSTER KIT TO YOUR GAUGES.

**CONNECTOR F** - Plug this connector into the mating connector on the dash harness (bag G), route the wires to the circuit board and cut to length.  
Connect wires as follows:

DARK BLUE	Right Dash Indicator	Install terminal A, and plug into connector B in the location shown on sheet 2.
LIGHT BLUE	Left Dash Indicator	Install terminal A, and plug into connector B in the location shown on sheet 2.
LIGHT GREEN	Hi Beam Indicator Light	Install terminal A, and plug into connector B in the location shown on sheet 2.
DARK GREEN	Water Temp Sender	Install terminal A, and plug into connector B in the location shown on sheet 2.
DARK BLUE	Oil Pressure Sender	Install terminal A, and plug into connector B in the location shown on sheet 2.
TAN	Gas Gauge	Install terminal A, and plug into connector B in the location shown on sheet 2.
TAN (no printing)	Brake Light Switch	Install terminal A, and plug into connector B in the location shown on sheet 2.

**CONNECTOR G** - Plug this connector into the mating connector on the dash harness (bag G), route the wires to the circuit board and cut to length.  
Connect wires as follows:

PINK	12v Ignition	Double this wire with a length of the cutoff wire, install terminal A and plug into connector B in the location shown on sheet 2. Route the other end of the doubled wire to the circuit board and cut to length. Install terminal A, and plug into connector B in the location shown on sheet 2. This pink connection has two plug in locations into connector B as shown on sheet 2.
GRAY	Dash Lights	Install terminal A, and plug into connector B in the location shown on sheet 2.
BLACK	Ground	Install terminal A, and plug into connector B in the location shown on sheet 2.

**CONNECTOR H** - The wires in this connector are used **ONLY** with an electronic speedometer. This connector will plug into the dash harness connection in bag G.  
PURPLE VSS Signal Connect to the speedometer 'sender' terminal following the manufacturer's instructions.  
YELLOW VSS Ground Connect to the ground terminal "-" on the speedometer following the manufacturer's instructions.  
PURPLE/WHITE VSS Power Connect to the speedometer sender 'power' terminal following the manufacturer's instructions.  
PINK/WHITE Speedo Power Connect to the speedometer 'power' terminal following the manufacturer's instructions.  
BLACK/WHITE Speedo Ground Connect to a good cluster ground following the manufacturer's instructions.

**CONNECTOR I** - This connection is for a factory dash mounted clock harness. This connection can also be used for a constant battery constant battery source to aftermarket gauges.

YELLOW Clock Battery Connect to dash mounted clock harness (not included in kit). If you require a replacement clock harness, CA01548, it is available from American Autowire or at [www.americanautowire.com](http://www.americanautowire.com).

**LOOSE WIRES**

WHITE Coil--> Tach **Used ONLY with a tachometer.** Plug this wire into connector F, maintaining color continuity with the white "TACH" wire on the mating dash connector. Route the other end of this wire to the circuit board or aftermarket tach and cut to length. Install terminal A, and plug into connector B in the location shown on sheets 2 or 3.

BROWN Alternator Ign **Used with a stock alternator lamp.** Plug this wire into connector F, maintaining color continuity with the brown "ALTERNATOR IGN" wire on the mating dash connector. Route other end of this wire to the circuit board and cut to length. Install terminal A, and plug into connector B in the location shown on sheet 2.

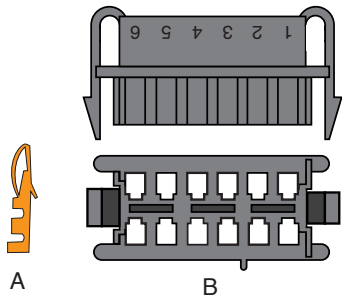

[www.americanautowire.com](http://www.americanautowire.com) 856-933-0801

Classic Update Series  
1970-73 Camaro

bag  
**H**

**INSTRUMENT CLUSTER**

**510515**

92972492 instruction rev 1.0 JDM 02/10/2023

USE THIS SHEET TO CONNECT TO AN ORIGINAL 1970-73 CAMARO  
FACTORY INSTRUMENT CLUSTER WITH A CIRCUIT BOARD CONNECTION

Classic Update Series

CIRCUIT BOARD CONNECTOR  
WITH WARNING LIGHTS

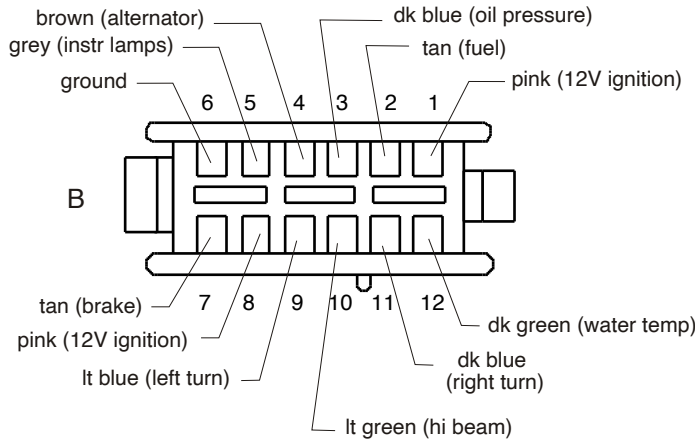

CIRCUIT BOARD CONNECTOR  
WITH GAUGES

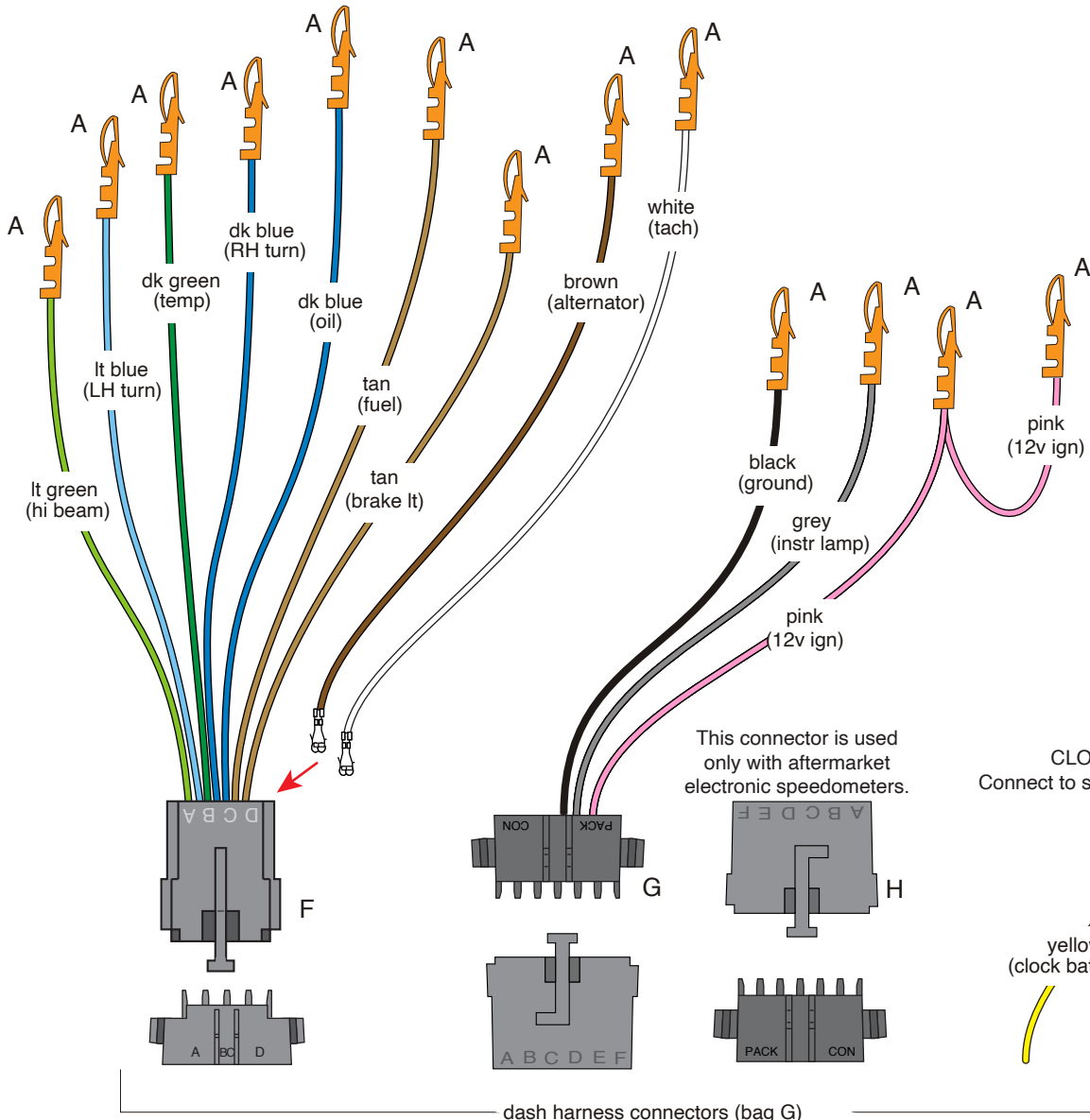
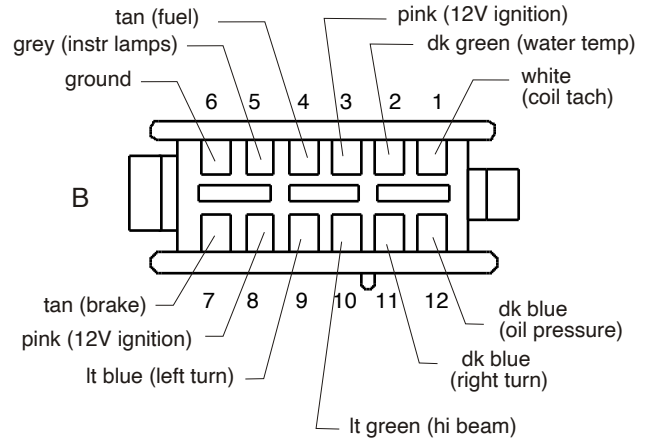

**American  
Autowire**

1970-73 Camaro  
INSTRUMENT CLUSTER  
**510515**

Gauge Cluster harness (aftermarket gauges) installation instructions:

Classic Update Series

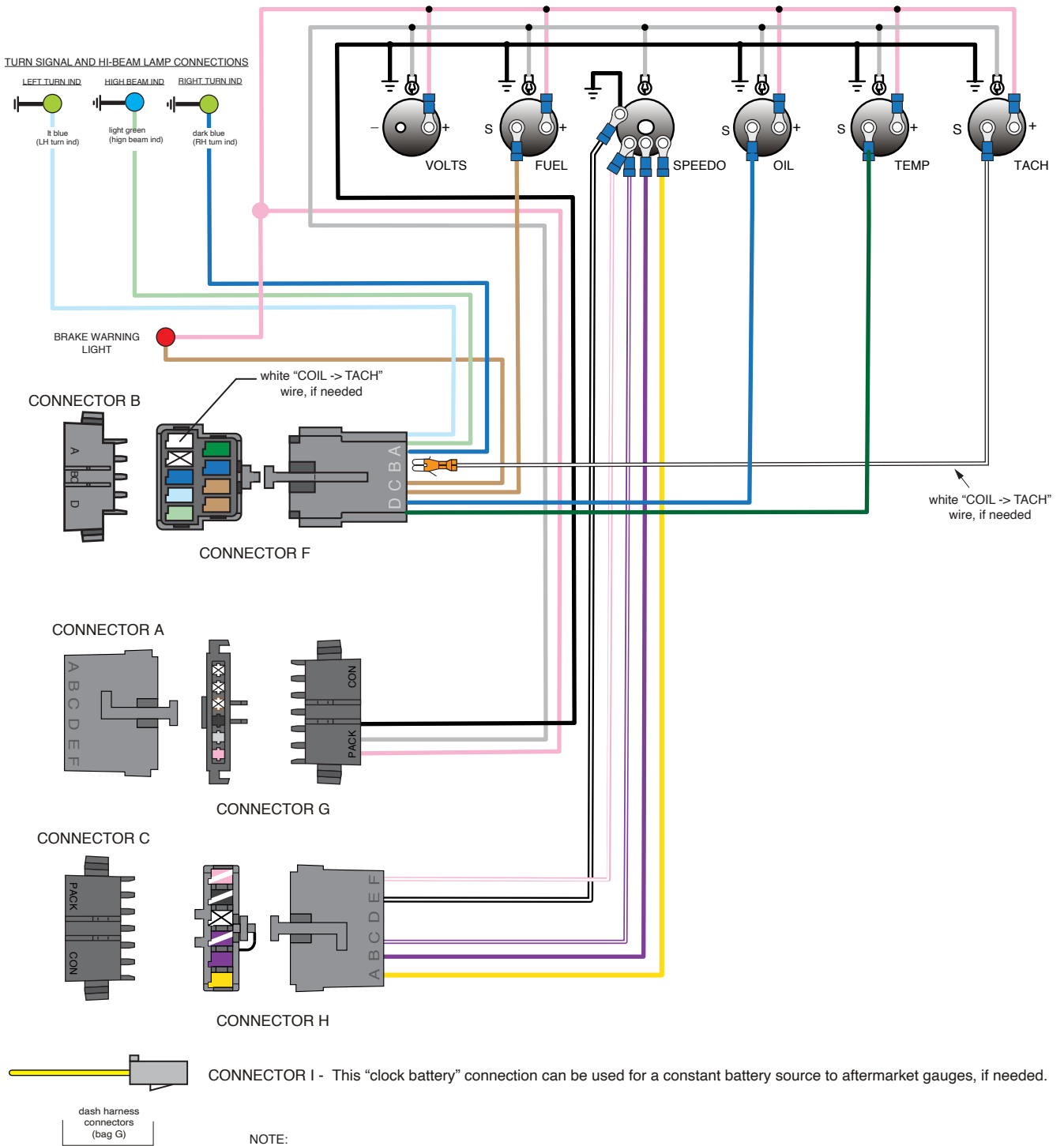

NOTE:

These are general instructions for hooking up aftermarket gauges with an electric speedometer. Connector (H) and the wires in Connector H will ONLY be used in the event that you are utilizing an aftermarket electric speedometer. If your car does NOT have an electric speedometer, Connector H will NOT be used and should not be plugged onto your dash harness. It is best to consult the speedometer manufacturer's instructions if you have any questions.

- Yellow** VSS Ground Connect to VSS neg. "-" on speedometer.
- Purple** VSS Signal Connect to VSS input on speedometer.
- Purple/White** VSS Power Connect to 12V power on speedometer.
- Black/White** Speedo Ground Connect to ground on speedometer.
- Pink/White** Speedo Power Connect to 12v power on speedometer.  
NOTE: This wire will double onto the same stud as the purple/white VSS power wire from above.





# Classic Update Series

THIS PAGE INTENTIONALLY LEFT BLANK



## Electric Speedo VSS extension connection:

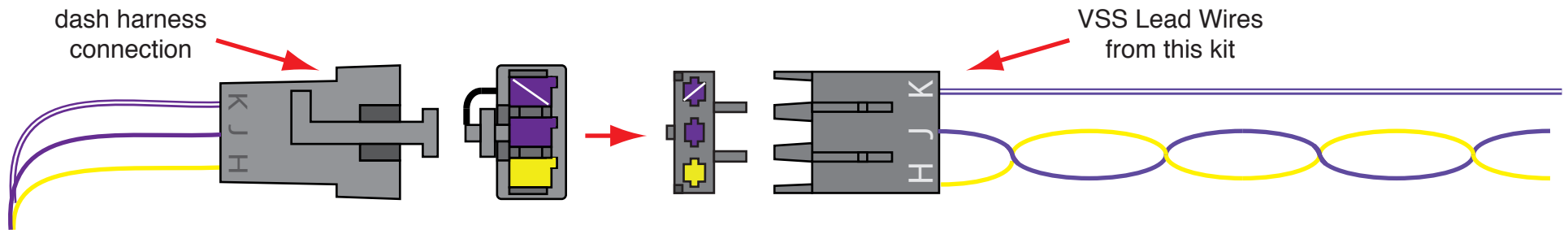

If you are using an aftermarket electric speedometer in your vehicle, you will need to connect the vehicle speed sensor (VSS) Lead Wires from this kit to the dash side connection of your dash harness. The yellow and solid purple wires must remain twisted together as shown above. These three wires will need to pass through the firewall or floor of your vehicle down to the vehicle speed sensor unit in the transmission. Generally, the solid purple wire connects to the “signal” lead, the yellow wire connects to the “ground” lead, and the purple/white stripe wire connects to the “12 volt power” lead on the vehicle speed sensor assembly. However, you should consult the directions that came with your gauges, and connect your vehicle speed sensor per the manufacturer’s instructions.



[www.americanautowire.com](http://www.americanautowire.com) 856-933-0801

VSS LEAD WIRES  
Various Applications  
Classic Update Series

**510730**

92972371 Rev 0.0 4/9/2019

bag  
**V**

A  (1)  
 (144.0" 6 Gauge charge wire)

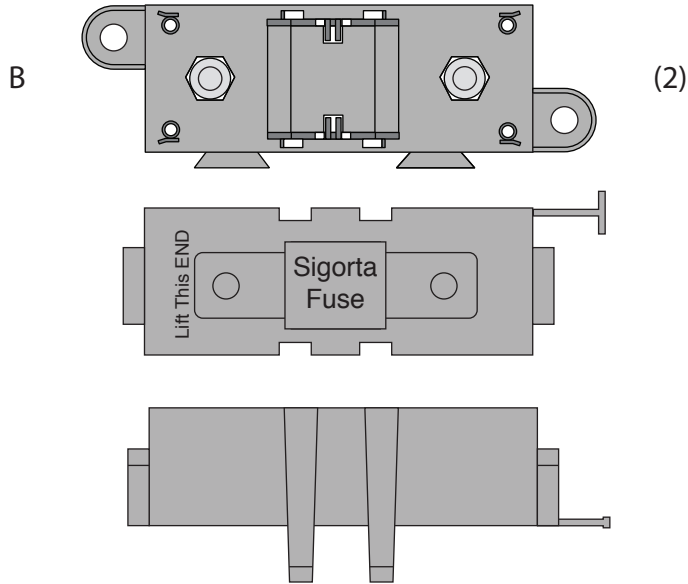

1. On this page, you will find the wire, fuse bodies, fuses, boot, ring terminals, and shrink tubing (items A through K) that are necessary to connect your alternator and main power feed for your new AAW wiring kit. Please be sure that all of the necessary components are present before starting this portion of your installation. If anything is missing, stop what you are doing and contact AAW at the number listed below right away.

2. On page 2, you will find directions for building the 2 Megafuse assemblies (items B,C and D) into one unit.

3. On page 3, you will find an overall concept of how to connect the Megafuse assemblies to your starter solenoid, alternator and main power feed of your new wiring system.

4. On page 4, you will find tips on building your charging circuit wires and assembling them and the main panel power feed wire to the Megafuse assemblies.

(Megafuse body, cover and two M8 x 1.25 nuts / lock washers)

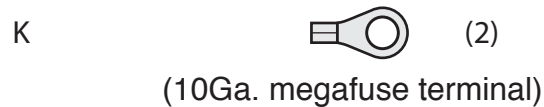
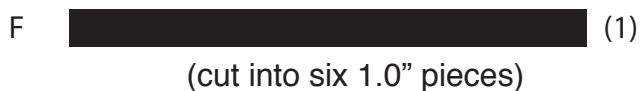
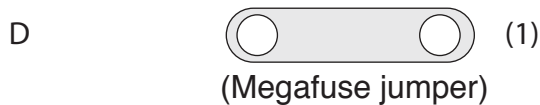
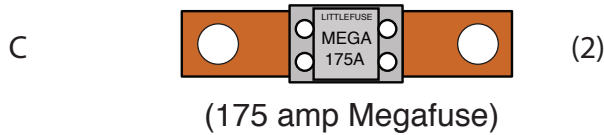

www.americanautowire.com 856-933-0801

PART #

510476

Z

DESCRIPTION:

Alternator and Main Power  
 Connection Kit  
 Various Applications

92972153 instruction sheet rev 0.1 6/24/2019

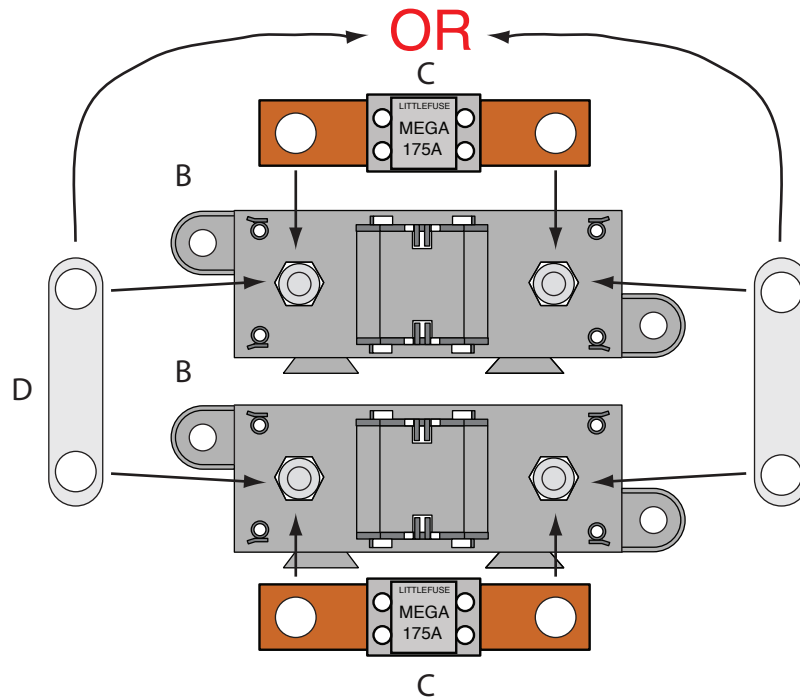

## Assembling the (2) Megafuse assemblies

**NOTE:** Find a suitable place, as close to the battery power source as possible, under the hood of your vehicle to mount the completed Megafuse assemblies. Keep in mind that you have 12 feet of 6Ga. charging wire, and that the main power feed coming from your panel or bulkhead connection must also be able to reach the assembly.

1. Take the two Megafuse bodies and covers (items B) and snap them together. Remove the 4 nuts and lock washers from the studs on the fuse body assemblies.
2. Install the Megafuse jumper (item D above) over two of the studs on the Megafuse bodies. It is very important that the jumper **MUST BE** assembled on the side that is going to connect to your main power connection (starter solenoid or battery feed).
3. Notch top cover to clear jumper D as shown at right.
4. Snap one 175amp fuse (items C) onto the studs of each of the two Megafuse bodies (items B), over the jumper, then loosely re-attach the 4 nuts and lock washers back onto the assembled Megafuses. The fuse assemblies are ready to install into your vehicle.

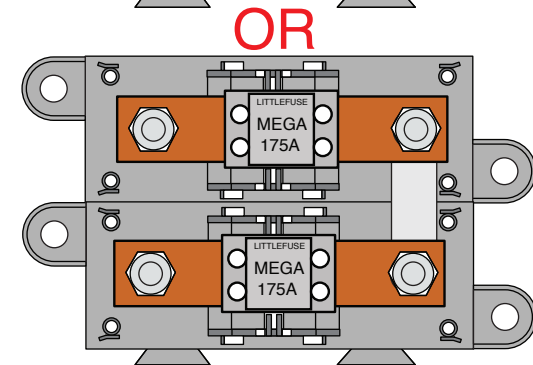
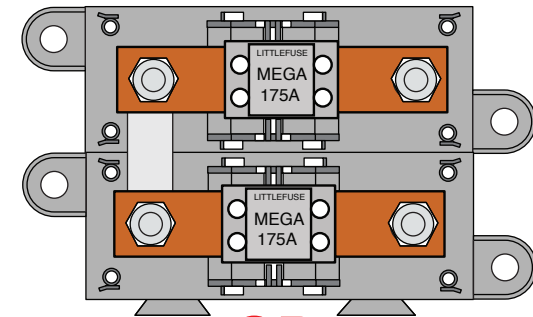

## Assembled Megafuses

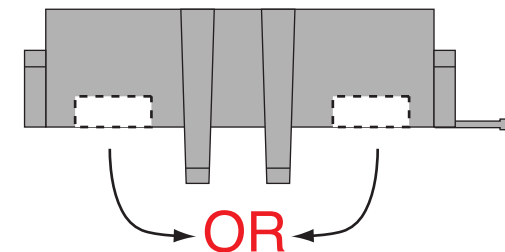

## Notched Cover

PART #

**510476**

**Z**

DESCRIPTION:

Alternator and Main Power  
Connection Kit  
Various Applications

92972153 instruction sheet rev 0.1 6/24/2019

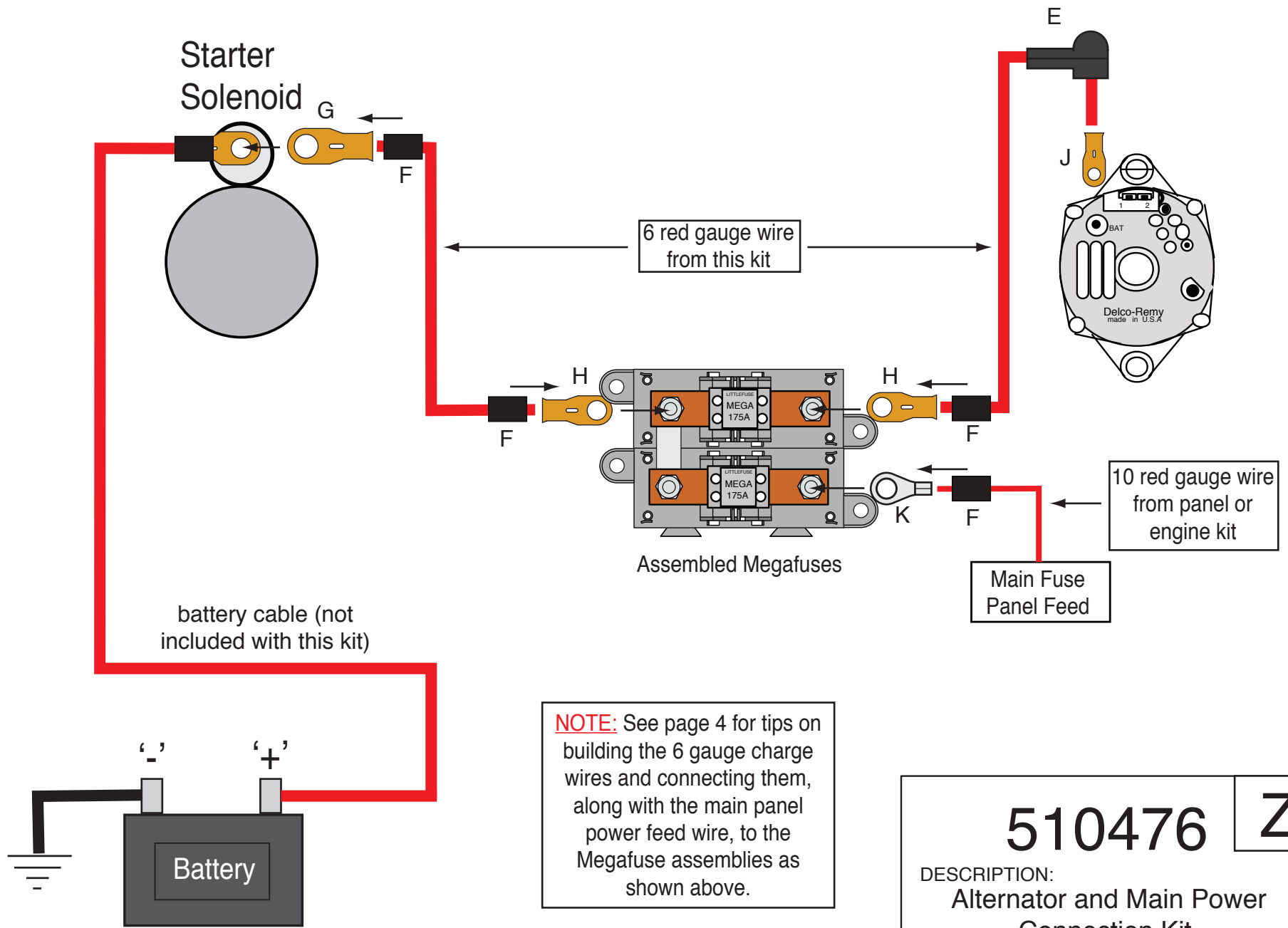

**NOTE:** See page 4 for tips on building the 6 gauge charge wires and connecting them, along with the main panel power feed wire, to the Megafuse assemblies as shown above.

<h1>510476</h1>	<h1>Z</h1>
<p>DESCRIPTION:  <b>Alternator and Main Power Connection Kit</b>  <b>Various Applications</b></p>	
<p>92972153 instruction sheet rev 0.1 6/24/2019</p>	

## **Building the 6Ga. charge wires and connecting them and the main panel power feed wire to the Megafuse assemblies:**

**NOTE:** Make sure that your battery is disconnected! You will need to install the preassembled Megafuses from page 2 in your vehicle to start this part of the installation.

1. Pre-cut item F shrink tubing into (6) 1.00" - 1.25" pieces.
2. Take the 12-foot piece of 6Ga. red wire from this kit and route it from your starter (or other battery feed) over to the area where you have mounted your Megafuse and cut it to length. Strip the insulation on each end back 1/2". Install 2 pieces of shrink tubing F onto the wire. At the starter end, crimp and solder (1) of terminal G onto the wire. At the Megafuse end, crimp and solder (1) of terminal H onto the wire. Slide the shrink tubing over the terminals and heat it up to shrink it down.
3. Take the remaining portion of the 12-foot piece of 6Ga. red wire from this kit and route it from your alternator over to the area where you have mounted your Megafuse and cut it to length. Strip the insulation on each end back 1/2". Install 1 piece of shrink tubing F onto the wire. At the alternator end, slip on boot E as shown on page 3, then crimp and solder (1) of terminal J onto the wire. At the Megafuse end, crimp and solder (1) of terminal H onto the wire. Slide the shrink tubing over terminal H and heat it up to shrink it down.
4. Take the 10Ga. red main power feed wire from your engine or panel sub-kit and route it over to the area where you have mounted your Megafuse and cut it to length. Strip the insulation back 3/8". Install 1 piece of shrink tubing F onto the wire, then crimp and solder (1) of terminal K onto the wire.
5. Remove the 4 loosely tightened nuts and lock washers from the assembled Megafuses, then using the drawing on page 3 as a guide, install your pre-assembled wires from steps 2-4 above. Re-install the 4 nuts and lock washers onto the assembled Megafuses and tighten them down. This part of your installation is now complete.

**510476**

**Z**

DESCRIPTION:

**Alternator and Main Power  
Connection Kit  
Various Applications**

92972153 instruction sheet rev 0.1 6/24/2019

# Classic Update Series

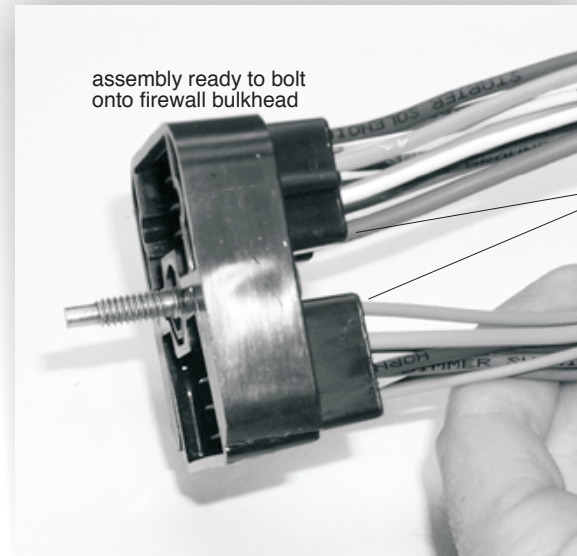
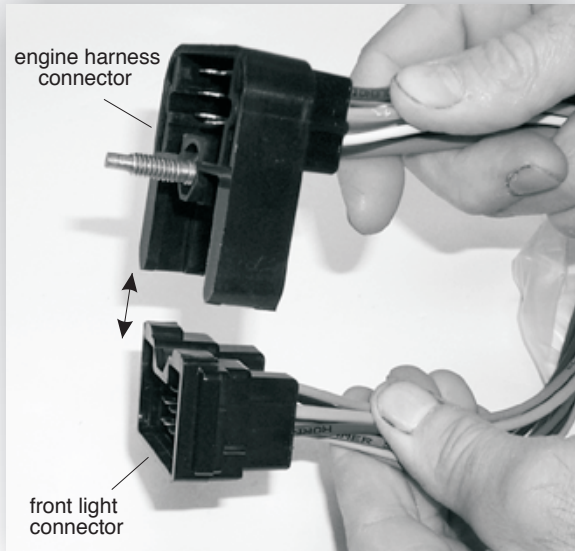

apply silicone sealant to back side of connector after installing terminals

The bulkhead connector from this Engine kit must snap into the mating engine connector (bag L), as shown. After snapping together, then bolt the assembly into the dash harness firewall connector using the attached bolt.

Look!



American Autowire also sells factory OEM style harness wrap. This is the same stuff used on original engine harnesses! If you want that OEM look with your Classic Update wiring system, then give us a call and order p/n R0067108!



**American  
Autowire**

www.americanautowire.com 856-933-0801

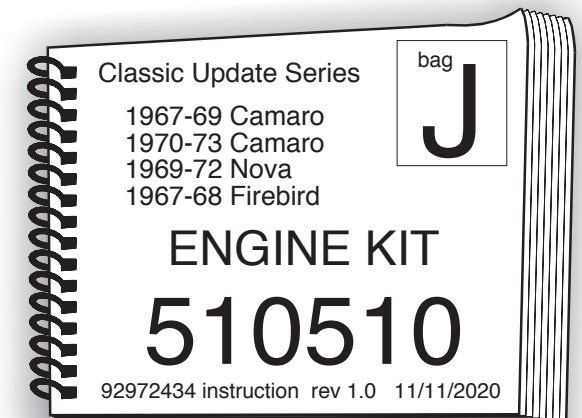

## Terminals used in this installation.

This kit contains loose piece terminals and connectors necessary to complete a connection to a specific component. Each connection on the instruction sheet identifies specific parts by a letter code that corresponds to the letter code on a part picture identified below. The parts below are shown in actual size to help in identification. This kit will only contain those parts required for the connections in the specific sub-kit you are working on. Just match the part to the picture below to identify the part letter code you will see on the instruction sheet for the sub-kit harness you are working on. We have supplied additional terminals in the event that extra terminals are necessary.

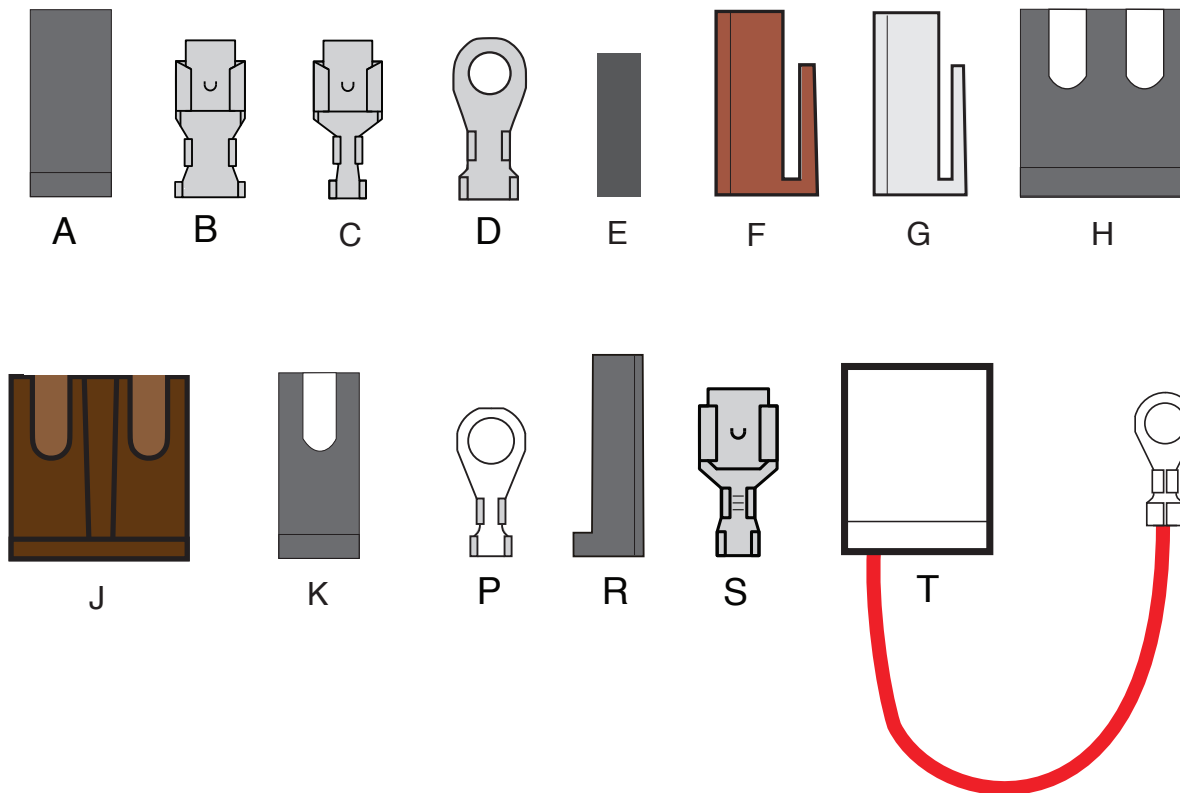

**American  
Autowire**

www.americanautowire.com 856-933-0801

ENGINE KIT

**510510**

92972434 instruction rev 1.0 11/11/2020



ALTERNATOR BOOT  
(FROM 510476 KIT)

10 GA. RED (12 V BATTERY)  
(FROM 500668 KIT)

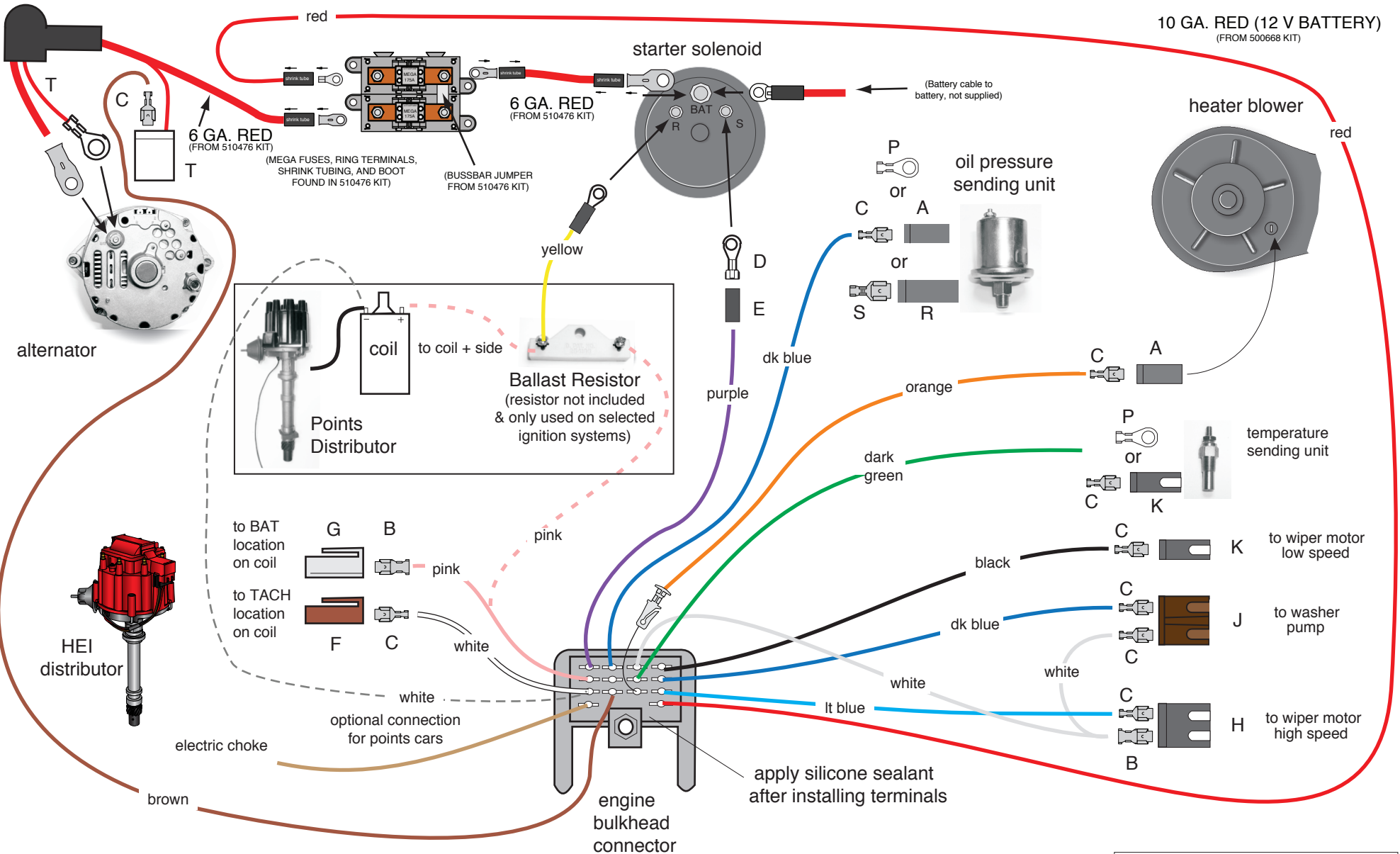

**NOTE:** See page 5 of this instruction set for some typical wiper connection photographs



www.americanautowire.com 856-933-0801

**ENGINE KIT**  
**510510**  
92972434 instruction rev 1.0 11/11/2020

# Classic Update Series

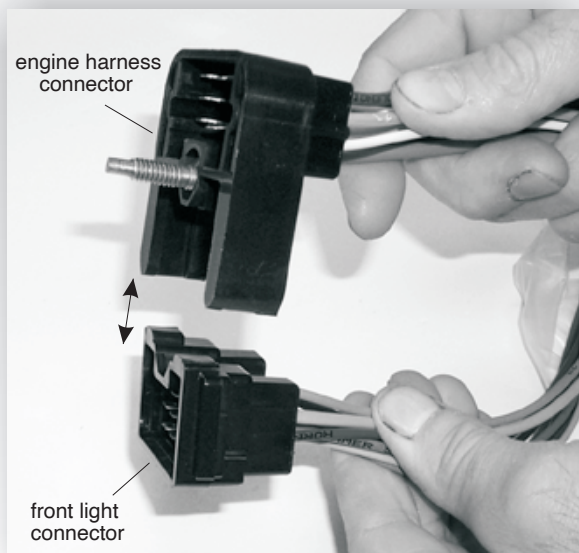

The bulkhead connector from this front light kit must snap into the mating engine connector (bag J), as shown. After snapping together, then bolt the assembly into the dash harness firewall connector using the attached bolt.

Look!



American Autowire also sells factory OEM style harness wrap. this is the same stuff used on original Camaro harnesses! If you want that OEM look with your Classic Update wiring system, then give us a call and order p/n R0067108 !



Terminals used in this installation.

This kit contains loose piece terminals and connectors necessary to complete a connection to a specific component. Each connection on the instruction sheet identifies specific parts by a letter code that corresponds to the letter code on a part picture identified below. The parts below are shown in actual size to help in identification. This kit will only contain those parts required for the connections in the specific sub-kit you are working on. Just match the part to the picture below to identify the part letter code you will see on the instruction sheet for the sub-kit harness you are working on. We have supplied a few additional terminals in the event that extra ones are necessary.

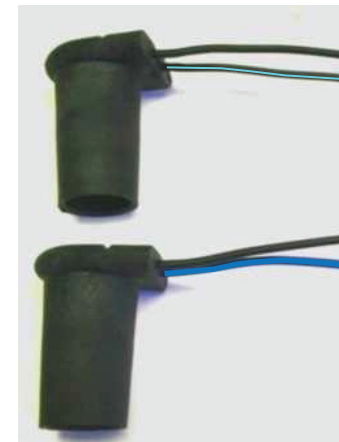
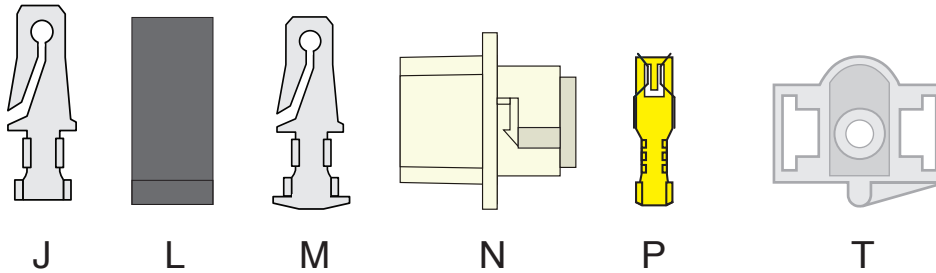
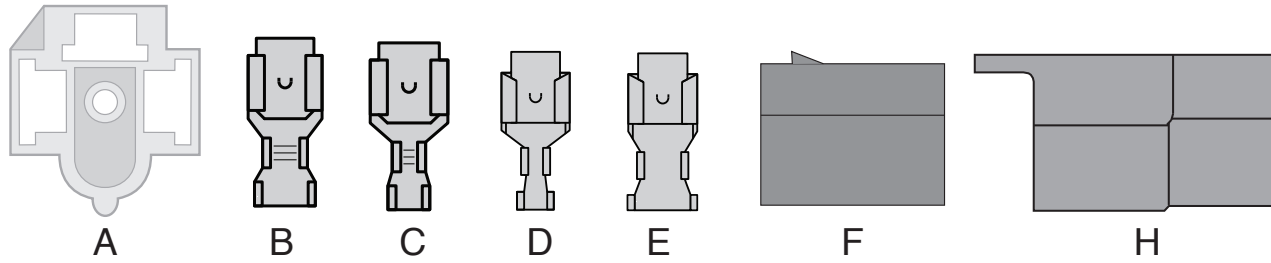

REF: These extensions can be found in 500887

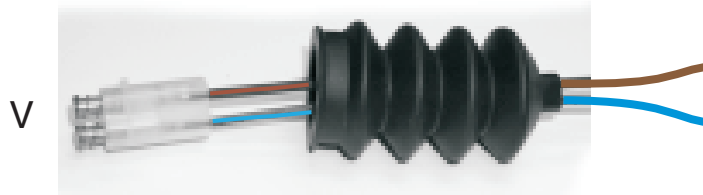

REF: These extensions can be found in 500737



www.americanautowire.com 856-933-0801

FRONT LIGHT KIT

510511

92972437 instruction rev 1.0 JDM 2/08/2023



## 1967-68 Camaro Standard Front Lighting

Connect the bulkhead connector from this kit onto the bulkhead connector from the engine kit (bag J), and bolt to the firewall dash bulkhead.

LIGHT BLUE	LEFT FRONT TURN	Route this wire to the LH turn signal lamp install terminal M, and plug into connector H as shown on sheet 3.
DARK BLUE	RIGHT FRONT TURN	Route this wire to the RH turn signal lamp install terminal M, and plug into connector H as shown on sheet 3.
BROWN	PARK LIGHTS	Route one of the brown wires from the bulkhead connector to the LH (driver side) turn signal lamp and cut to length. Double this wire with the cut off portion, install terminal J, and plug into connector H with the light blue wire from above as shown on sheet 3. Route the other end of this brown wire connection to the LH side marker lamp, cut to length, install terminal P, and plug this connection into the LH side marker lamp socket N as shown on sheet 3. (Also plug the pre-assembled black ground wire into lamp socket N, as shown on sheet 3.) Route the other brown wire from the bulkhead connector to the RH turn signal lamp and cut to length. Double this wire with the cut off portion, install terminal J, and plug into connector H with the dark blue wire from above as shown on sheet 3. Route the other end of this brown wire connection to the RH side marker lamp, cut to length, install terminal P, and plug this connection into the RH side marker lamp socket N as shown on sheet 3. (Also plug the pre-assembled black ground wire into lamp socket N, as shown on sheet 3.)

**NOTE:** We have provided parking lamp assemblies V (500737) for you to install into your **standard Camaro** parking lamp housings. Install terminals D and connectors F onto each pigtail assembly, as shown on sheet 3, (maintaining color continuity with connector H from above), then plug into connector H to complete your parking lamp circuits.

TAN	HEADLIGHT LOW BEAM	Route this wire to the LH (driver side) headlight and trim to length. Double this wire with the cut off portion, and install terminal B. Plug this terminal into connector A, in the location shown on sheet 3. Route the remaining portion of this tan wire to the RH (passenger side) headlight and trim to length. Install terminal C and connector A, in the location shown on sheet 3.
LIGHT GREEN	HEADLIGHT HIGH BEAM	Route this wire to the LH (driver side) headlight and trim to length. Double this wire with the cut off portion, and install terminal B. Plug this terminal into connector A, in the location shown on sheet 3. Route the remaining portion of this light green wire to the RH (passenger side) headlight and trim to length. Install terminal C and connector A, in location shown on sheet 3.
BLACK	GROUND	Install terminal C and plug into connector A, in the location shown on sheet 3. Connect the ring terminal to a good chassis ground. Complete for each headlight.
DARK GREEN	HORN	Route to horns and install terminals D & E, as shown on sheet 3, Plug into connectors L.
ORANGE	ELECTRIC FAN	Route to the electric fan, and connect per manufacturer's instructions. <b>NOTE:</b> This wire must only be used as the trigger wire for the electric fan relay. American Autowire manufactures relay kits for this application.
TAN	BRAKE LIGHT SWITCH	Plug wire pigtail S into the front light connector in the location shown on sheet 3. Plug the other end onto the stock brake sender switch as shown on sheet 3.

# Classic Update Series

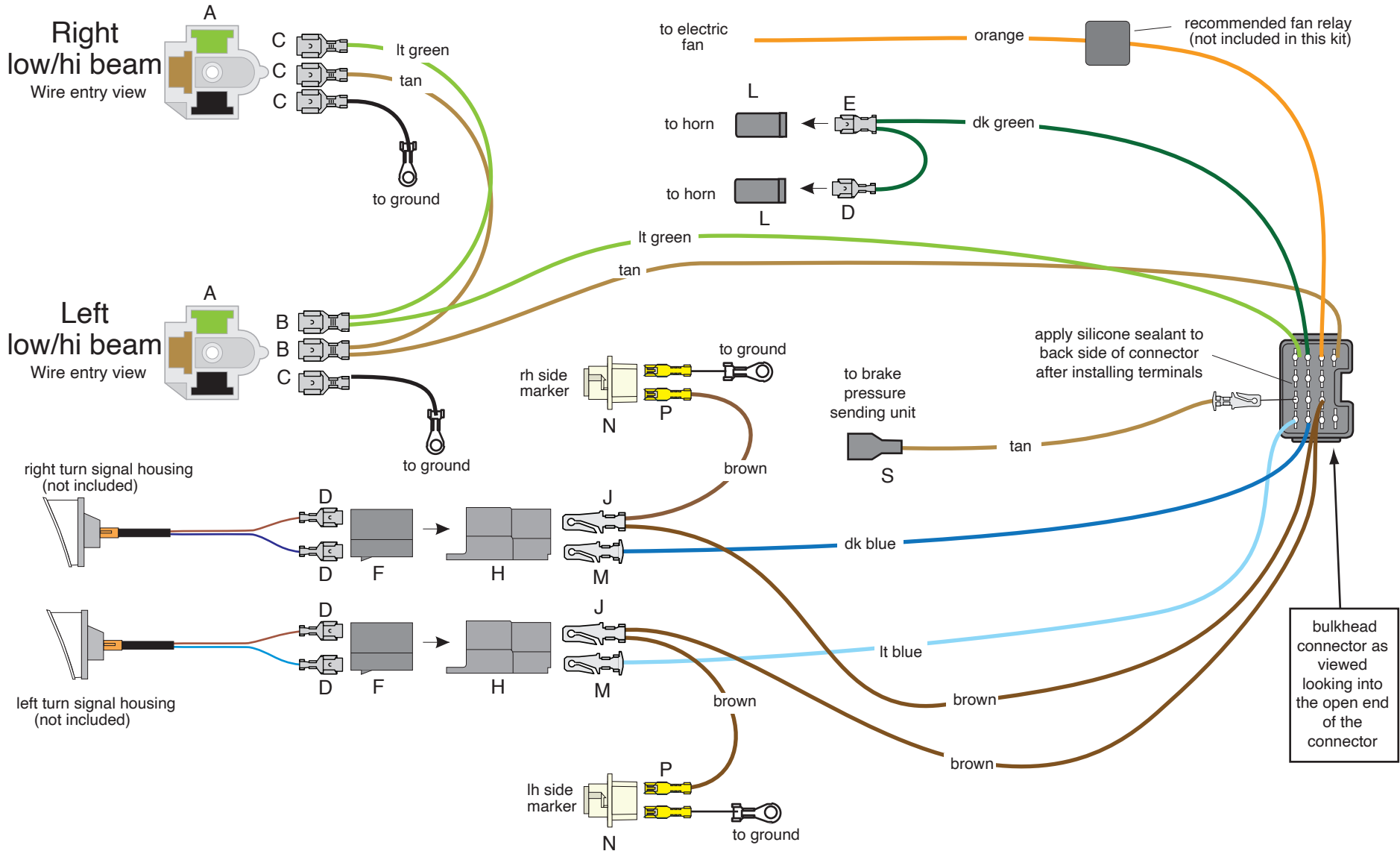

1969-72 Nova, All  
 1967-68 Camaro, Rally Sport Front Light  
 1969 Camaro, Standard and Rally Sport Front Light  
 1970-73 Camaro, Standard and Rally Sport Front Light



www.americanautowire.com 856-933-0801

FRONT LIGHT KIT

510511

92972437 instruction rev 1.0 JDM 2/08/2023

1967-68 Camaro Rally Sport Front Lighting, 1969 Camaro Standard and Rally Sport Front Lighting  
 1969-72 Nova Front Lighting, 1970-73 Camaro Standard and Rally Sport Front Lighting

Connect the bulkhead connector from this kit onto the bulkhead connector from the engine kit (bag J), and bolt to the firewall dash bulkhead.

LIGHT BLUE	LEFT FRONT TURN	Route this wire to the LH turn signal lamp install terminal M, and plug into connector H as shown on sheet 5.
DARK BLUE	RIGHT FRONT TURN	Route this wire to the RH turn signal lamp install terminal M, and plug into connector H as shown on sheet 5.
BROWN	PARK LIGHTS	Route one of the brown wires from the bulkhead connector to the LH (driver side) turn signal lamp and cut to length. Double this wire with the cut off portion, install terminal J, and plug into connector H with the light blue wire from above as shown on sheet 5. Route the other end of this brown wire connection to the LH side marker lamp, cut to length, install terminal P, and plug this connection into the LH side marker lamp socket N as shown on sheet 5. (Also plug the pre-assembled black ground wire into lamp socket N, as shown on sheet 5.) Route the other brown wire from the bulkhead connector to the RH turn signal lamp and cut to length. Double this wire with the cut off portion, install terminal J, and plug into connector H with the dark blue wire from above as shown on sheet 5. Route the other end of this brown wire connection to the RH side marker lamp, cut to length, install terminal P, and plug this connection into the RH side marker lamp socket N as shown on sheet 5. (Also plug the pre-assembled black ground wire into lamp socket N, as shown on sheet 5.)

**NOTE:** The running and directional light assemblies use factory parking lamp housing assemblies that are not serviceable. To connect them, plug completed connector H (on the wires above) onto the factory parking lamp housing assemblies as shown on sheet 5. New terminals D and connectors F have been provided in the event that your originals are damaged or are missing.

TAN	HEADLIGHT LOW BEAM	Route this wire to the LH (driver side) headlight and trim to length. Double this wire with the cut off portion, and install terminal B. Plug this terminal into connector A, in the location shown on sheet 5. Route the remaining portion of this tan wire to the RH (passenger side) headlight and trim to length. Install terminal C and connector A, in the location shown on sheet 5.
LIGHT GREEN	HEADLIGHT HIGH BEAM	Route this wire to the LH (driver side) headlight and trim to length. Double this wire with the cut off portion, and install terminal B. Plug this terminal into connector A, in the location shown on sheet 5. Route the remaining portion of this light green wire to the RH (passenger side) headlight and trim to length. Install terminal C and connector A, in the location shown on sheet 5.
BLACK	GROUND	Install terminal C and plug into connector A, in the location shown on sheet 5. Connect the ring terminal to a good chassis ground. Complete for each headlight.
DARK GREEN	HORN	Route to horns and install terminals D & E, as shown on sheet 5, Plug into connectors L.
ORANGE	ELECTRIC FAN	Route to the electric fan, and connect per manufacturer's instructions. <b>NOTE:</b> This wire must only be used as the trigger wire for the electric fan relay. American Autowire manufactures relay kits for this application.
TAN	BRAKE LIGHT SWITCH	Plug wire pigtail S into the front light connector in the location shown on sheet 5. Plug the other end onto the stock brake sender switch as shown on sheet 5.



# Classic Update Series

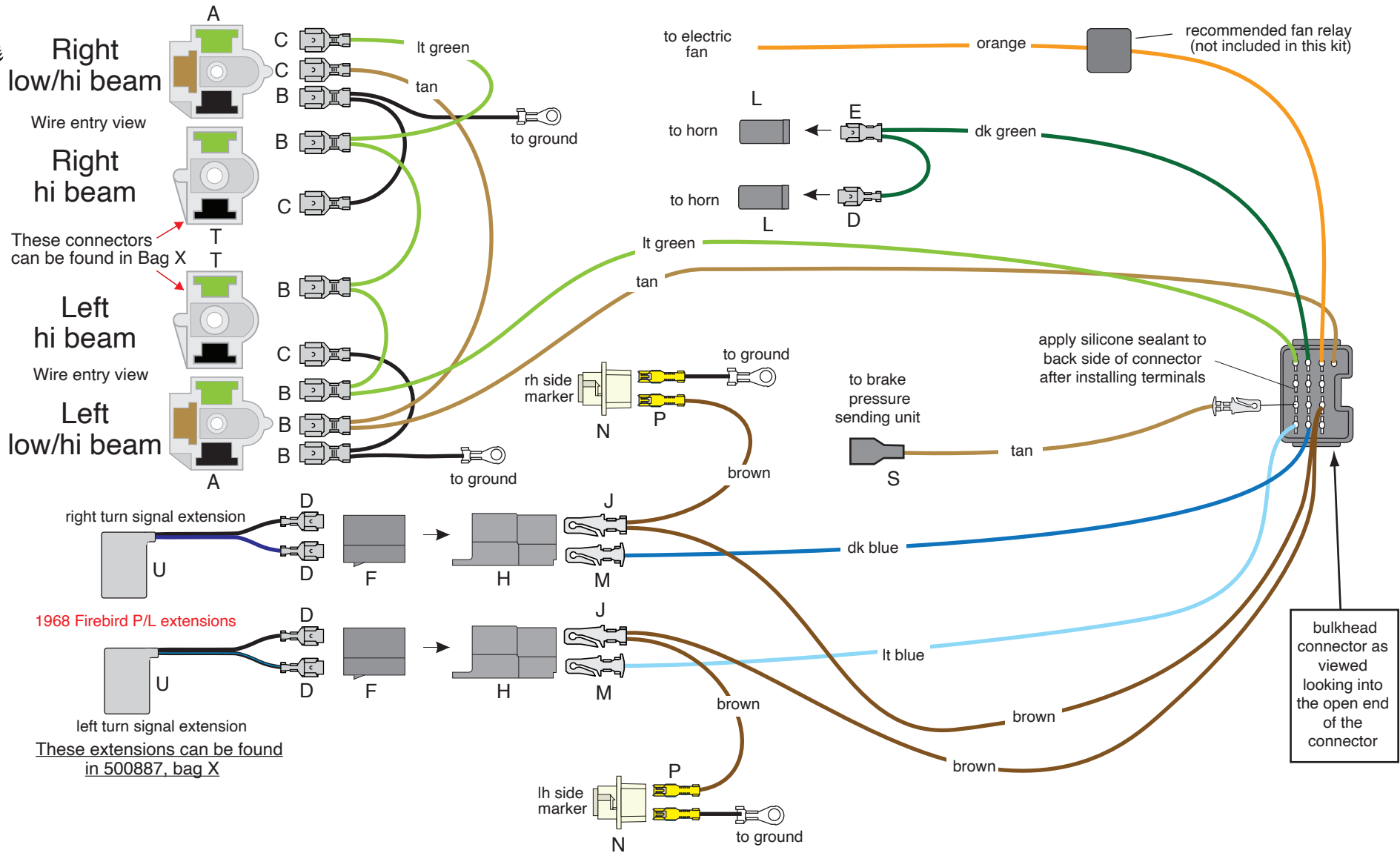

1967-68 Firebird  
Front Light



www.americanautowire.com 856-933-0801

FRONT LIGHT KIT

510511

92972437 instruction rev 1.0 JDM 2/08/2023



## 1967-68 Firebird Front Lighting

Connect the bulkhead connector from this kit onto the bulkhead connector from the engine kit (bag J), and bolt to the firewall dash bulkhead.

LIGHT BLUE	LEFT FRONT TURN	Route this wire to the LH turn signal lamp install terminal M, and plug into connector H as shown on sheet 7.
DARK BLUE	RIGHT FRONT TURN	Route this wire to the RH turn signal lamp install terminal M, and plug into connector H as shown on sheet 7.
BROWN	PARK LIGHTS	Route one of the brown wires from the bulkhead connector to the LH (driver side) turn signal lamp and cut to length. Double this wire with the cut off portion, install terminal J, and plug into connector H with the light blue wire from above as shown on sheet 7. Route the other end of this brown wire connection to the LH side marker lamp, cut to length, install terminal P, and plug this connection into the LH side marker lamp socket N as shown on sheet 7. (Also plug the pre-assembled black ground wire into lamp socket N, as shown on sheet 7.) Route the other brown wire from the bulkhead connector to the RH turn signal lamp and cut to length. Double this wire with the cut off portion, install terminal J, and plug into connector H with the dark blue wire from above as shown on sheet 7. Route the other end of this brown wire connection to the RH side marker lamp, cut to length, install terminal P, and plug this connection into the RH side marker lamp socket N as shown on sheet 7. (Also plug the pre-assembled black ground wire into lamp socket N, as shown on sheet 7.)

**NOTE:** The running and directional light housings on all **1968 Firebirds** utilized a unique connection assembly. We have provided you with two pigtailed U (500887, bag X) to plug into your factory housings. The black-black/light blue is for your LH (driver side) lamp, and the black/dark blue is for the RH (passenger side) lamp. Plug these pigtailed onto your lamp housings, trim the wires to length, install terminals D and plug into connectors F as shown on sheet 7. Plug completed pigtail assemblies U, with connector F installed on them, into connectors H (as shown on sheet 7) to complete your front parking lamp circuits. The running and directional light assemblies on all **1967 Firebirds** will simply plug into the completed connectors H from above.

TAN	HEADLIGHT LOW BEAM	Route this wire to the driver side outer headlight and trim to length. Double this wire with the cut off portion and install terminal B. Plug this terminal into connector A, in the location shown on sheet 7. Route the remaining portion of this tan wire to the passenger side outer headlight and trim to length. Install terminal C and plug into connector A, in the location shown on sheet 7.
LIGHT GREEN	HEADLIGHT HIGH BEAM	Route this wire to the driver side outer headlight and trim to length. Double this wire with the cut off portion and install terminal B. Plug this terminal into connector A, make a short jumper over to the driver side inner headlight, cut to length, double it with the cutoff portion, install terminal B, and plug it into connector T in the location shown on sheet 7. Route the remaining portion of this light green wire to the passenger side inner headlight and trim to length. Double this wire with the cutoff portion, install terminal B and plug into connector T as shown on sheet 7. Make a short jumper over to the passenger side outer headlight, cut to length, double it with the cutoff portion, install terminal C, and plug it into connector A in the location shown on sheet 7.
BLACK	GROUND	Route this wire to the driver side outer headlight and trim to length. Double this wire with the cutoff portion, and install terminal B. Plug this terminal into connector A, take the short jumper over to the driver side inner headlight, cut to length, install terminal C, and plug it into connector T in the location shown on sheet 7. Repeat this process for the passenger side.
DARK GREEN	HORN	Route to horns and install terminals D & E, as shown on sheet 7, Plug into connectors L.
ORANGE	ELECTRIC FAN	Route to the electric fan, and connect per manufacturer's instructions. <b>NOTE:</b> This wire must only be used as the trigger wire for the electric fan relay. American Autowire manufactures relay kits for this application.
TAN	BRAKE LIGHT SWITCH	Plug wire pigtail S into the front light connector in the location shown on sheet 7. Plug the other end onto the stock brake sender switch as shown on sheet 7.

TEMPORARILY, PLUG THE MAIN BULKHEAD CONNECTOR FROM THIS KIT INTO THE MATING CONNECTOR ON THE DASH BULKHEAD CONNECTOR ( LOCATED UNDER THE MASTER CYLINDER) Note: This will be unbolted to install the front light harness later.

## BULKHEAD CONNECTOR WIRES:

RED	12V BATTERY	Route this wire to the Megafuse and cut to length. Use ring terminal, shrink tubing from 510476 kit. Connect as shown on sheet 3.
PURPLE	STARTER SOLENOID	Route to the starter solenoid and cut to length. Install rubber sleeve E and ring D. Connect to the 'S' terminal on solenoid.
DK BLUE	OIL PRESSURE SENDER	Connect this wire to the oil pressure sending unit. Using terminal P, terminal C with connector A, or terminal S with connector R.
ORANGE	HEAT / AIR	If using after-market air conditioning, this wire will not be used. If using a stock heater only system, route this wire to the heater blower, cut to length. Install terminal C and connector A and plug into the blower unit. Plug the other end into the engine bulkhead connector as shown on sheet 3.
DK GREEN	WATER TEMP SENDER	Connect this wire to the temperature sending unit using terminal P or terminal C with connector K (depending on your sending unit).
PINK	12V IGNITION	If using an HEI distributor, or after-market ignition system which requires a 12V feed: Route the PINK wire to the coil and trim to length. Install terminal C and connector G, and plug into distributor cap BAT location.
PINK	12V IGNITION	If using a points type ignition system which required reduced voltage:
YELLOW	STARTER SOLENOID-R	Route the PINK wire to the ignition feed side of the ballast resistor (not included in this kit). Connect the loose piece YELLOW (STARTER SOLENOID-R) wire to the R terminal on the starter and connect the other end to the coil side of the ballast resistor (not included in this kit). Connect a piece of the left over PINK wire to the coil side of the ballast resistor and route the to the distributor coil + side. Connect the distributor input lead wire to the coil negative (-) side.
WHITE	COIL-TACH	Route this wire to he coil and trim to length. If using an HEI distributor, terminal B and connector F are included for connection. Plug into the TACH location on the HEI distributor, or attach to the negative side of coil in a points type system.
TAN	ELECTRIC CHOKE	If you are using a carburetor with an electric choke, connect this wire to the electric choke connection. If you are not using an electric choke or a turbo 400 transmission, remove this wire from the engine bulkhead connector

The following wires are for use on a stock wiper system. If using an after-market wiper system, follow the manufacturer's instructions (see sheets 3 and 5 for details).

BLACK	WIPER LOW SPEED	Route to the wiper motor and trim to length. Install terminal C, plug into connector K, and plug into the low speed terminal of the wiper motor as shown on sheet 5.
DK BLUE	WIPER WASHER	Route this wire to the washer pump and trim to length. Install terminal C and plug into BROWN connector J in the location shown on sheet 3.
LT BLUE	WIPER HI SPEED	Route this wire to the wiper motor and trim to length. Install terminal C and plug into BLACK connector H in the location shown on sheet 3.
WHITE	WIPER ACC	Route this wire to the wiper motor and trim to length. Double it with the cut off portion, install terminal B and plug into the open cavity of connector H as shown on sheet 3. Route the loose end of this wire to the washer pump, install terminal C and plug into open cavity of connector J as shown on sheet 3. Plug connector H onto the high speed terminals of the wiper motor as shown on sheet 5. Plug connector J onto the washer pump terminals of the wiper motor as shown on sheet 5.

## ALTERNATOR WIRES:

HEAVY RED		Use the 6ga red wire, boot and ring terminal from the 510476, route from alternator to the Megafuse and cut to length. Connect as shown on sheet 3.
SMALL RED		Send the ring terminal end of pigtail T through the boot (as shown on sheet 3) and connect to the battery stud on alternator. Do not plug the connector into the alternator yet as the exciter wire (Brown) needs to be added before the connector is plugged in.
BROWN	ALTERNATOR IGN	Route this wire to the alternator and cut to length. Install terminal C and plug into the regulator connector as shown on sheet 3.

Once the main connector has all of it's wires plugged in, the connector cavities should be sealed with di-electric grease on the terminals. Also, to assure a moisture resistant seal, silicone can be applied to seal the outside of the connector.

ENGINE KIT

510510

92972434 instruction rev 1.0 11/11/2020

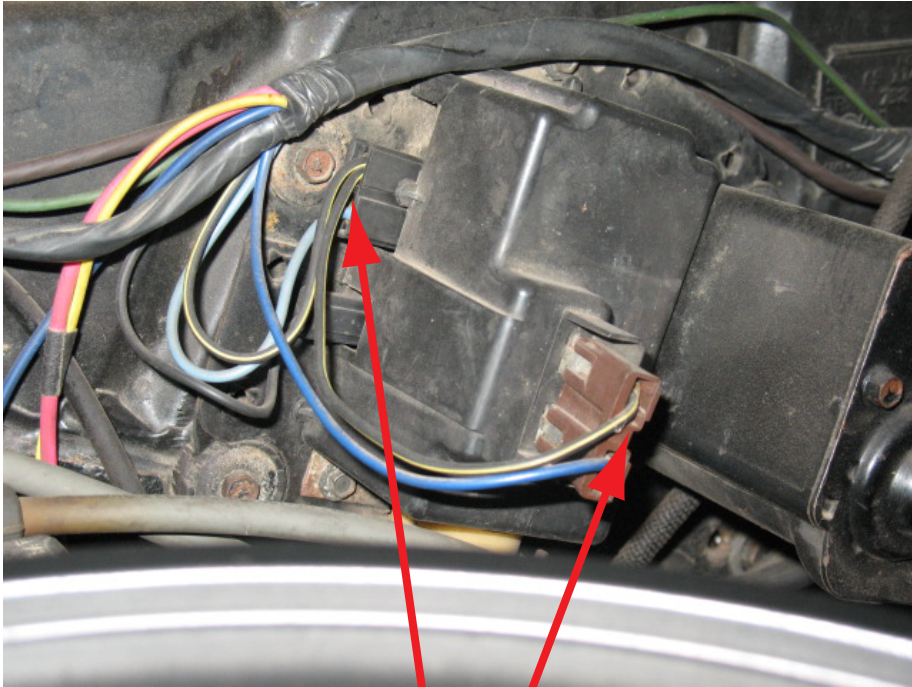

The photo above depicts the typical stock 1967-1969 Camaro (all), 1968-1972 Nova (all), 1967-1968 Firebird (all), and 1970-73 Camaro “without depressed park” wiper motor and washer pump connections. Where you see the black wire with the yellow strip in the photo, that would be equivalent to the AAW white “wiper feed” power wire.

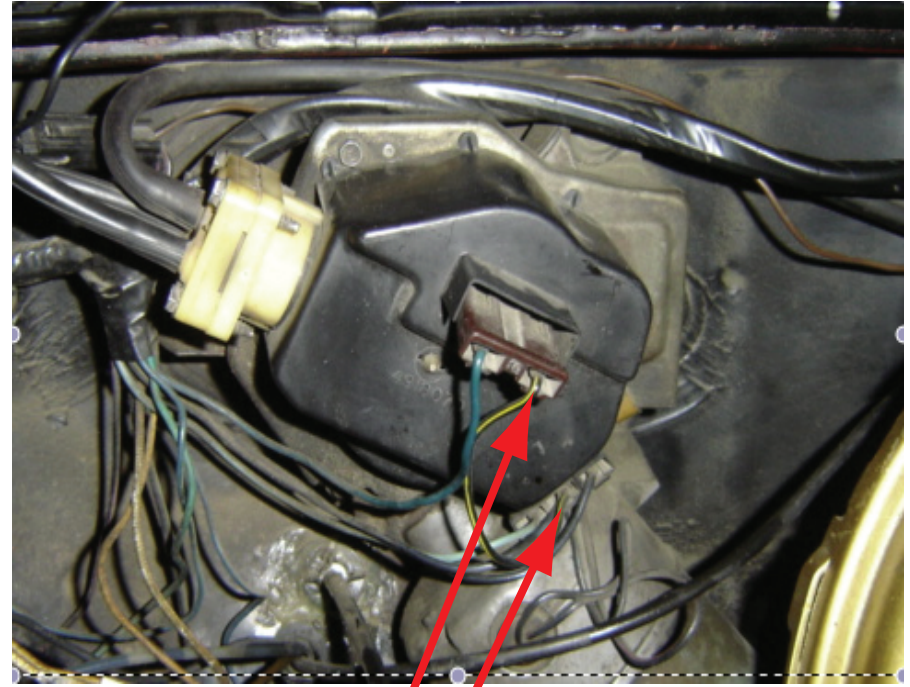

The photo above depicts the typical stock 1970-73 Camaro “with depressed park” wiper motor and washer pump connections. Where you see the black wire with the yellow strip in the photo, that would be equivalent to the AAW white “wiper feed” power wire.

This page intentionally left blank



[www.americanautowire.com](http://www.americanautowire.com) 856-933-0801

ENGINE KIT

**510510**

92972434 instruction rev 1.0 11/11/2020

# Classic Update Series

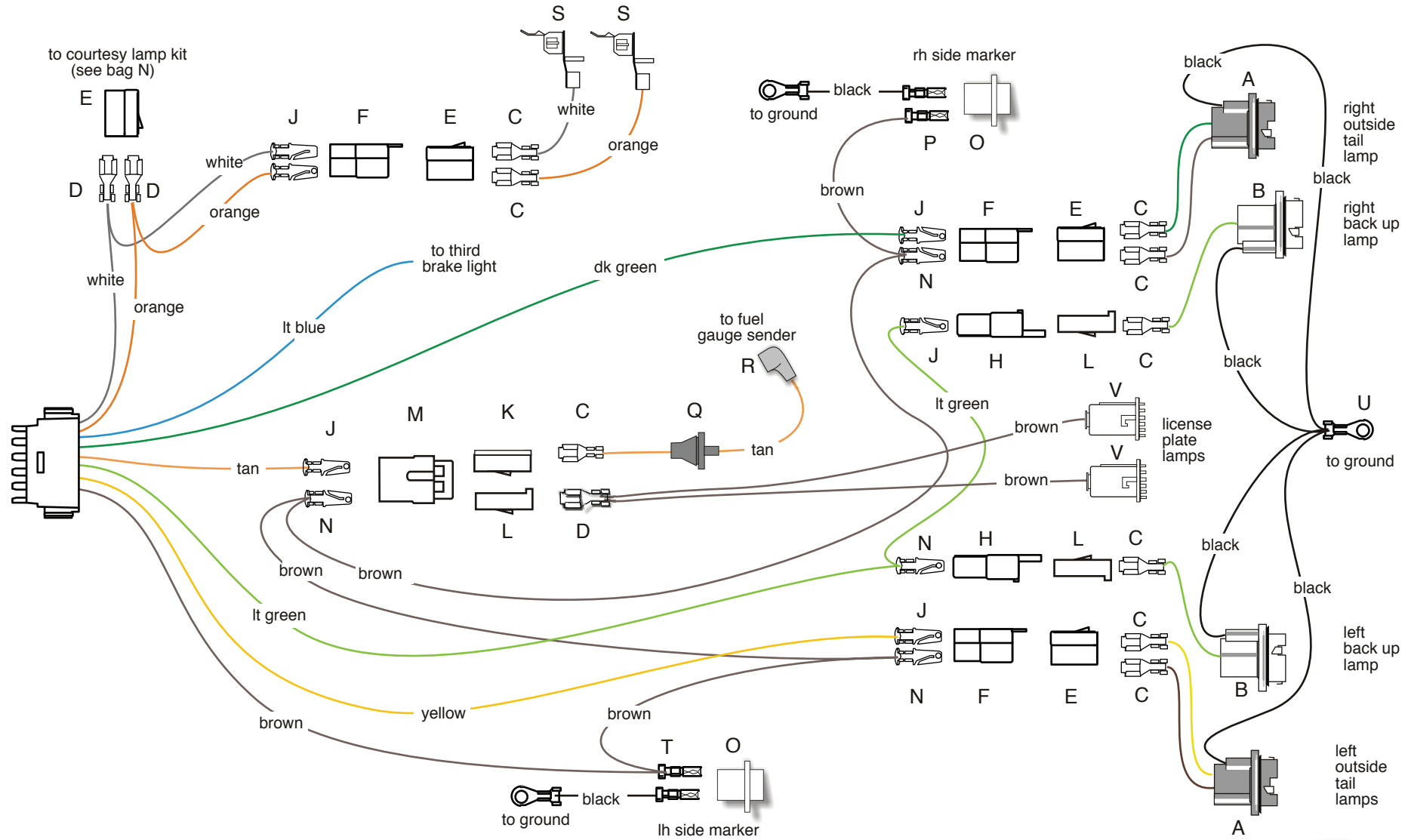

Use the loose piece tan wire (power lead) if you are using electric fuel pump.

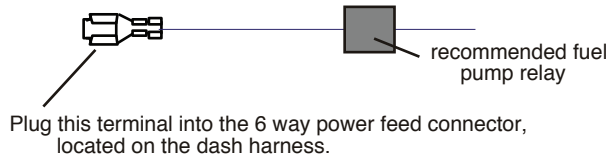

USE THIS SHEET FOR ALL 1970-73 CARS



**American Autowire**

www.americanautowire.com 856-933-0801

Classic Update Series  
1970-73 Camaro











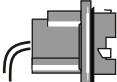
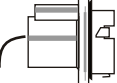



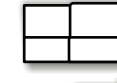

bag  
**M**

**REAR BODY KIT**

**510042**

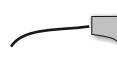
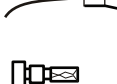
92968497 instruction rev 2.0 6/25/2013

## USE THIS SHEET FOR ALL 1970-73 CARS

A			Connect the main connector to the mating connector on the dash harness 500662 bag G. Route this harness along door sill and into trunk
B		LIGHT BLUE	Third brake light
			Connect to the third brake lamp, if equipped.
C		TAN	Fuel signal
			Route this wire to the rear panel of the trunk (near fuel tank filler) and trim to length. Install terminal J and plug into connector M, as shown on sheet 1.
D		TAN	Fuel Tank lead (with rubber end)
			Plug the rubber end of this wire R onto the sending unit on fuel tank. Route the wire to the stock feed thru hole under fuel tank filler and install rubber grommet Q in direction shown on sheet 1. Secure this wire into hole with the attached grommet. In the trunk area, trim this wire to reach connector M from wire above. Attach terminal C and plug into connector K. Plug connector K into mating connector M. This should match the tan wire from above.
E			Your existing license plate lamp wire will also plug into connector M. (Note: Terminal C and connector L are provided if you need to attach to your lamp wire.)
F		BROWN	Parking lamps
			Route this wire to the left side marker and trim to length. Double this wire with the cut off portion and install terminal T and plug into lamp socket O. Route the loose end to the LH tail lamps. Cut to length, and double this wire with the cut off portion, using terminal N. Plug this terminal into connector F, in location shown on Sheet 1. Route the loose end to connector M (from the tan wire above), and cut to length. Double this wire with the cut off portion and install terminal N. Plug this terminal into connector M, in location shown on sheet 1. Route the loose end to the RH tail lamps and repeat the procedure.
H			
J		BROWN	License plate lamps
			Take 2 license plate lamp sockets (V), mount lamps and route wire ends to connector (V). Cut to length and double together in terminal D. Plug this connection into connector L. Plug connector L into connector M.
K		BLACK	Side Marker Ground
			There are two loose black wires in this kit. Plug each into the rear side markers (connector O). Route the black wires to the rear panel support (near fuel tank filler), crimp on terminal U and attach to ground.
L		YELLOW	LH Stop / Tail
			Route this wire to the LH tail lamp and cut to length and install terminal J. Plug this wire into connector F from above. Install terminal C and connector E on the tail lamp pigtail A, maintaining color continuity with connector F. Plug connector E into connector F.
M		DK GREEN	RH Stop / Tail
			Route this wire to the RH tail lamp and cut to length and install terminal J. Plug this wire into connector F from above. Install terminal C and connector E on the tail lamp pigtail A, maintaining color continuity with connector F. Plug connector E into connector F.
N		LIGHT GREEN	Back up lamp feed
			Route this wire to the LH back up lamp and trim to length and install terminal N and connector H. Route the loose end of the lt green wire to the right side back up lamp. Repeat this procedure with terminal J. Install terminals C on each of the back up pigtails B, and plug into connectors H.
O		WHITE	Courtesy ground
			At the driver's side kick panel area, cut this wire and double it with the cut off portion using terminal D, and plug into connector E maintaining color continuity with the mating connector in the courtesy lamp kit (bag N).
P			
			If you are using a dome lamp, route the loose end of this wire to the rear pillar area of the trunk and install terminal J and connector F. Plug into connector F in location shown on Sheet 1. (Note: a factory dome lamp harness will also plug into this connector, if you are not replacing the headliner at this time.) Install the loose white wire S (supplied with terminal installed into the dome lamp. Route this wire to connector F (on white wire) location and trim to length. Install terminal C and connector E, maintaining color continuity with the white wire in connector F.
Q		ORANGE	Courtesy Lamp
			At the driver's side kick panel area, cut this wire and double it with the cut off portion using terminal D, and plug into connector E maintaining color continuity with the mating connector in the courtesy lamp kit (bag N).
R			
			If you are using a dome lamp, route the loose end of this wire to the rear pillar area of the trunk and install terminal J and connector F. Plug into connector F in location shown on Sheet 1. (Note: a factory dome lamp harness will also plug into this connector, if you are not replacing the headliner at this time.) Install the loose orange wire S (supplied with terminal installed) into the dome lamp. Route this wire to connector F (on orange wire) location and trim to length. Install terminal C and connector E, maintaining color continuity with the orange wire in connector F.
S			
			This wire can be used if you are using an electric fuel pump. Plug the terminated end into the 6 way power disconnect on the dash harness, maintaining color continuity with the tan wire in the mating connector. Route the other end to a fuel pump relay (not included in this kit, but available from American Autowire).
T			
U		TAN	Fuel Pump
V			

Most switches supplied with Classic Update and Universal Kits ship with the shaft pre-installed. In many instances, the switch can be installed without removing the shaft, but in some cases the switch shaft may need to be trimmed to fit your specific dash. In this situation, reference Trim to Fit instructions on the back of this page for details.

### To install your new headlight switch:

1. Install the switch from behind the dash, and align the switch body with the mounting hole. The switch body has an alignment tab that must line up with the notch in the dashboard mounting hole.

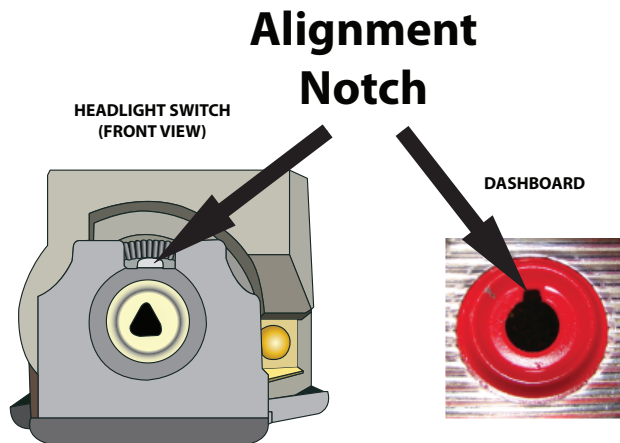







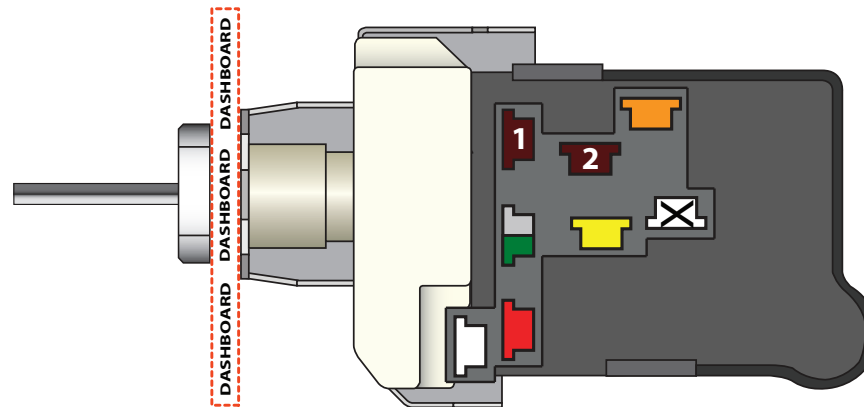

2. Install the switch mounting nut and tighten.

3. Gently press shaft into switch until it stops, then press firmly until it “clicks.” Pull shaft back out to confirm it is seated correctly. The shaft should be locked into place inside switch.

4. If the shaft does not lock, reinsert applying moderate pressure and slowly move shaft side to side for lock to engage. Make sure switch body is still supported to prevent flexing. Press shaft firmly until it clicks into place.

5. Ensure the shaft is fully seated and in the off position.



<b>1</b>	Parking Lights - Stay on with headlights
<b>2</b>	Tail Lights - On in the park and headlight positions
	Fused Battery Feed - For park, tail and dash lamps
	Headlight Feed - Power to the headlight dimmer switch
	12V Battery Feed - Unfused power to the switch for headlights
	Courtesy Ground - Ground feed to the dome and courtesy lights
	Part-Time Parking Lights - Turns off when the headlights are on (Not supported by all kits)
	OR
	



www.americanautowire.com 856-933-0801

PART #

**500332**

DESCRIPTION:

**Headlight Switch**

92964649

Rev 3.0

1/3/2020

## To Trim Shaft to Fit or Remove Shaft:

The headlight shaft knob should extend from the face of the mounting nut, and must allow enough clearance for the switch to turn off. If the shaft is longer than necessary for your specific dash it can be trimmed to fit. Always trim the knob end of the shaft only and follow the guidelines below for best results.

1. With the headlight switch installed, loosen the set screw and remove the knob. Make sure the switch is in the "off" position by pushing the shaft toward the back of the switch.

**Switch in OFF position**  
(shaft pushed all the way in)

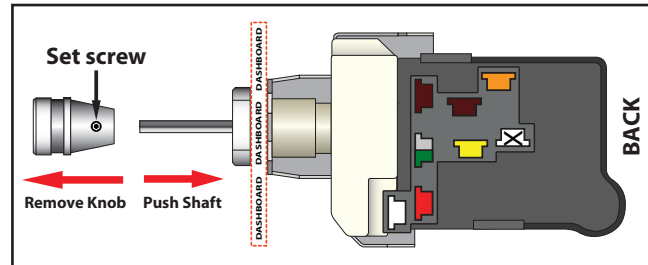

2. Set knob alongside shaft and mark the desired location for cutting on the shaft.

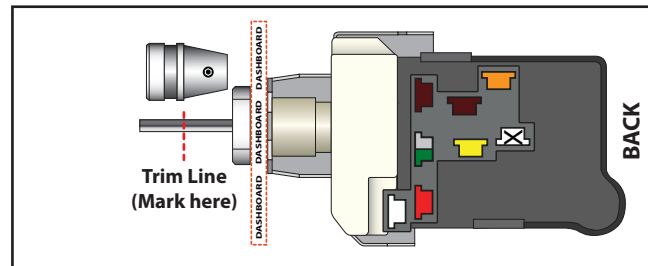

3. Remove the shaft and trim at mark. The shaft can be released from the switch by pulling it outward (toward the rear of the vehicle). Once fully in the "On" position, press and hold the release button on the base of the switch body. Once button is pressed, continue to pull the shaft outward. New switches may be tight, and it might be necessary to move the shaft side to side slightly while pulling to release.

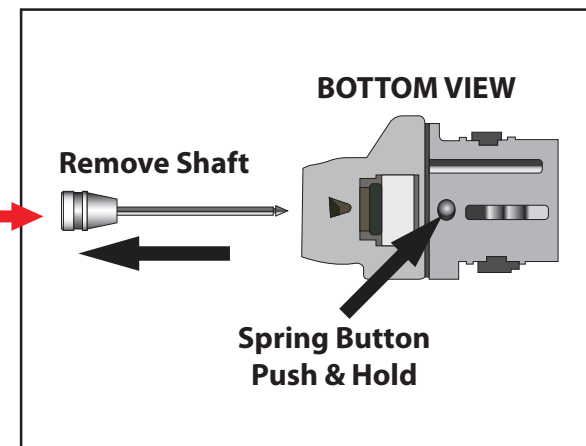
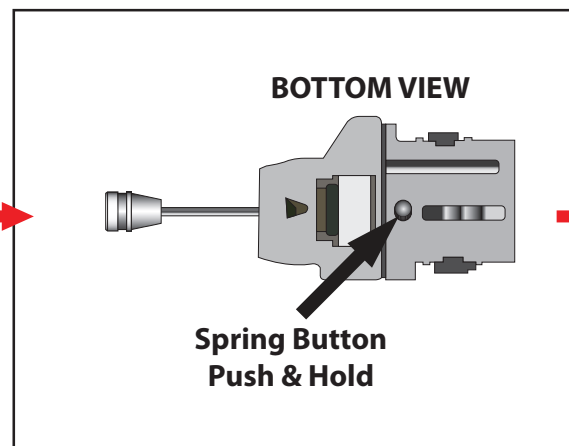
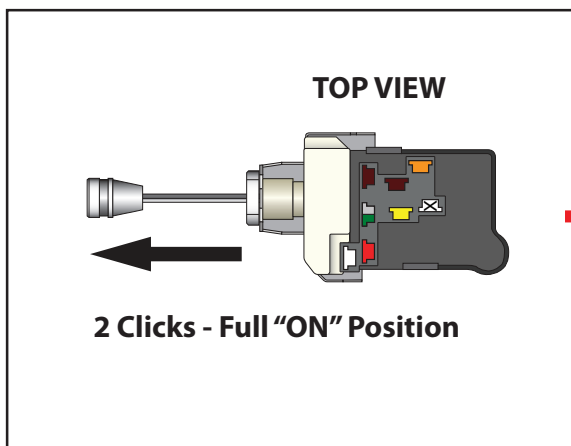



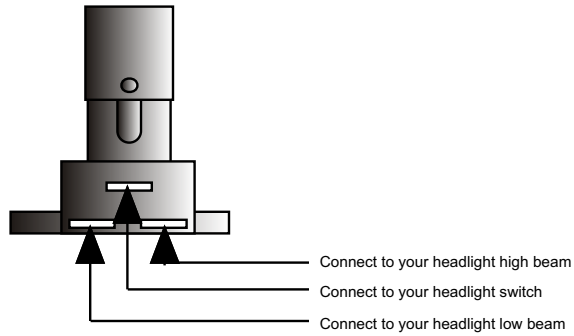

Connect the Dimmer Switch wires as shown above.

1. The top center terminal of the Dimmer Switch is connected to the Headlight switch.
2. The terminal on the right side is connected to your headlight high beam terminal.
3. The terminal on the left side is connected to your headlight low beam terminal.

another wiring product by...



150 Heller Pl #17 W Bellmawr, NJ 08031 856-933-0801

PART #

**500042**

DESCRIPTION:

**DIMMER SWITCH**

92964573 instruction sheet Rev 3.0 6/29/99

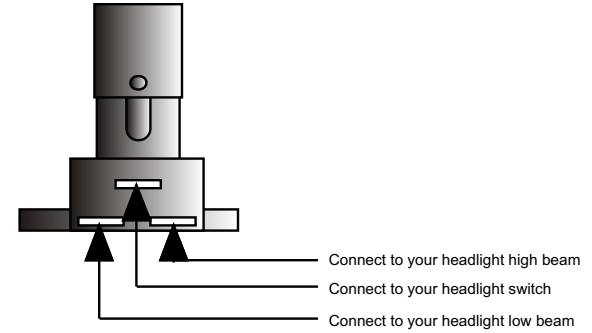

Connect the Dimmer Switch wires as shown above.

1. The top center terminal of the Dimmer Switch is connected to the Headlight switch.
2. The terminal on the right side is connected to your headlight high beam terminal.
3. The terminal on the left side is connected to your headlight low beam terminal.

another wiring product by...



150 Heller Pl #17 W Bellmawr, NJ 08031 856-933-0801

PART #

**500042**

DESCRIPTION:

**DIMMER SWITCH**

92964573 instruction sheet Rev 3.0 6/29/99